

HNO/SINUSKOPIE
ENT/SINUSCOPY
ORL/SINUSCOPIA

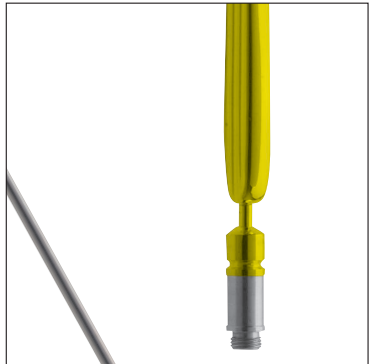

REDA
INSTRUMENTE GMBH

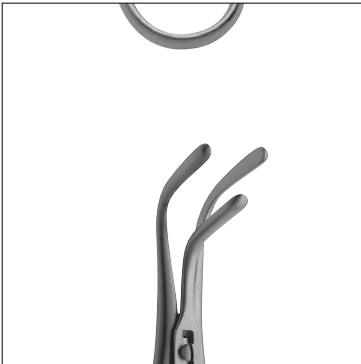

Reda Instrumente GmbH
Gänsäcker 34 - P.O. Box 131
D-78532 Tuttlingen

Telefon +49/7462/9445-0
Telefax +49/7462/9445-20
e-mail: info@Reda-Instrumente.de
<http://www.Reda-Instrumente.de>

Ausgabe Nr. 1
Datum: 12/2016



Charrière (Ch) French (F)	Durchmesser in mm	Inches
1	0,33	0,013
2	0,67	0,025
3	1,00	0,039
4	1,33	0,051
5	1,67	0,065
6	2,00	0,0787
7	2,33	0,092
8	2,67	0,105
9	3,00	0,1181
10	3,33	0,131
11	3,67	0,144
12	4,00	0,1575
13	4,33	0,170
14	4,67	0,184
15	5,00	0,1968
16	5,33	0,210
17	5,67	0,223
18	6,00	0,2362
19	6,33	0,249
20	6,67	0,263
21	7,00	0,2756
22	7,33	0,288
23	7,67	0,302
24	8,00	0,3150
25	8,33	0,328
26	8,67	0,341
27	9,00	0,3543
28	9,33	0,367
29	9,67	0,380
30	10,00	0,3973
31	10,33	0,407
32	10,67	0,420
34	11,33	0,446
36	12,00	0,4724
38	12,67	0,494
40	13,33	0,5199
45	15,00	0,5905

Gauge (G)	Durchmesser in mm	Inches
35	0,13	0,005
34	0,18	0,007
33	0,20	0,008
32	0,23	0,009
31	0,25	0,010
30	0,30	0,012
29	0,33	0,013
28	0,36	0,014
27	0,41	0,016
26	0,46	0,018
25	0,51	0,020
	0,53	0,021
24	0,56	0,022
23	0,64	0,025
22	0,71	0,028
21	0,81	0,032
20	0,89	0,035
	0,97	0,038
19	1,07	0,042
18	1,27	0,050
17	1,50	0,059
16	1,65	0,065
15	1,83	0,072
14	2,11	0,083
13	2,41	0,095
12	2,77	0,109
11	3,05	0,120
10	3,40	0,134
9	3,76	0,148
8	4,19	0,165
7	4,57	0,180
6	5,16	0,203

1 OZ	0,028 ml
5 OZ	0,140 ml
16 OZ	0,450 ml

35 OZ	1,0 l
128 OZ	3,7 l



GARANTIE / WARRANTY / GARANTIA

GARANTIE

Wir gewähren auf alle **Reda**-Instrumente 5 Jahre Garantie. Voraussetzung ist der sach- und fachgerechte Einsatz der Instrumente. Von der Garantie sind Verschleißerscheinungen ausgeschlossen.

WARRANTY

Our **Reda** products are free from manufacturing defects in material and workmanship. We therefore give on all instruments a guarantee of five years provided that the instruments are maintained and cleaned properly and used normally for their intended purpose.

GARANTIA

Estamos convencidos de nuestra calidad y concedemos a todos los instrumentos de **Reda** 5 años de garantía contra cualquier defecto de fabricación, siempre y cuando se usen adecuadamente. De la garantía excluimos la manifestación de desgaste.

Arbeitsanweisung

Aufbereitung (Reinigung) und Sterilisation von resterilisierbaren chirurgischen Instrumenten

DIN EN ISO 17664:2004 (D)

Hersteller:
REDA Instrumente GmbH, Gänsäcker 34
78532 Tuttlingen

Alle von Reda gelieferten wieder verwendbaren Instrumente wurden ausschließlich für den chirurgischen Gebrauch konstruiert und dürfen zu keinen anderen Zwecken benutzt werden. Unsachgemäße Handhabung und sorglose Pflege sowie zweckentfremdeter Gebrauch können zu vorzeitigem Verschleiß der Instrumente führen. Die Produkte sind bei der Auslieferung nicht sterilisiert.

Reinigungsvorbereitung

Fabrikneue Instrumente müssen vor der ersten Anwendung den gesamten Aufbereitungsprozess durchlaufen. Instrumente unmittelbar nach Anlieferung aus den Folienverpackungen entnehmen und in trockenen Räumen bei gleichbleibender Raumtemperatur luftoffen lagern, um Kondensationsbildung zu vermeiden. Die Instrumente keinen Sonnenlichteinstrahlungen oder Dämpfen durch Chemikalien (Säuren oder scharfe Reinigern) aussetzen. Vor der ersten Sterilisation alle Schutzkappen und Folien vollständig entfernen und anschließend reinigen.

Gebrauchte Instrumente unmittelbar nach Beendigung des Eingriffs von Blut, Gewebe und Arzneimittel reinigen. Instrumente in eine freigegebene Lösung eines kombinierten Reinigungs- und Desinfektionsmittels, das keine proteinfixierende Wirkung besitzt, einlegen. Dosierung des Herstellers beachten. Nicht in NaCl Lösung einlegen, ansonsten Gefahr für Loch- bzw. Spannungsriss-Korrosion

Überfüllung von Instrumentensieben und Wascht-Trays vermeiden.

Gelenkinstrumente vor dem Aufbereiten öffnen. Zerlegbare Instrumente gemäß Bedienungsanleitung (Piktogramm) zur Reinigung zerlegen. Reinigungsgerechtes Zubehör verwenden. Für die manuelle Reinigung nie Metallbürsten oder Metallschwämme verwenden.

Spülmaschinen und Ultraschallanlagen nicht überladen. Spül- oder Schallschatten vermeiden. Dosierung, Einwirkzeit und Einwirktemperatur bei der Desinfektion und Reinigung unbedingt einhalten. Nach der Reinigung sorgfältig spülen. Möglichst vollentsalztes (demineralisiertes) Wasser verwenden.

Nach dem Spülen ausreichend trocknen.

Abgenutzte, korrodierte, deformierte, poröse oder anderweitig beschädigte Instrumente aussortieren.

Aus hygienischen Gründen müssen Instrumente, die zur Reparatur eingesandt werden komplett aufbereitet werden.

Gelenkinstrumente nach jeder Aufbereitung mit einem Pflegemittel auf Basis von Paraffinöl behandeln (gilt nicht für flexible Endoskope und Zubehör).

Funktionsprüfung in zusammengebautem Zustand durchführen.

Instrumente mit Rastensperre vor der Sterilisation nur im ersten Zahn schließen.

Als Sterilisationsverfahren empfehlen wir die Dampfsterilisation (üblicherweise mit Sattedampf bei 134° C)

Sterilisation ist kein Ersatz für Sauberkeit!

Die Broschüre "Instrumenten-Aufbereitung richtig gemacht" des Arbeitskreis Instrumenten-Aufbereitung dient als Anhalt.

Reda Instrumente GmbH
78532 Tuttlingen

IMPORTANT INFORMATION CONCERNING PREPARING AND STERILIZING SURGICAL INSTRUMENTS

Dear Sirs,

please read the following instructions very carefully before using the instruments.

1. INITIAL USE

All instruments which are being used for the first time must be thoroughly cleaned, rinsed and then sterilized before using.

2. TREATING INSTRUMENTS AFTER USAGE

- a.) The instruments might be immediately thoroughly cleaned and disinfected. Please follow the manufacturer's instructions when using cleaning agents and disinfectants.
- b.) Instruments which may be dismantled must be cleaned and disinfected after being taken apart.
- c.) Cleaning may be carried out either manually or with a machine. Care should be taken that only cleaning agents and disinfectants are used, which are changed daily.
- d.) Following chemical disinfection and manual cleaning, all instruments must always be thoroughly rinsed under running water.
- e.) The temperature of water used in a machine for cleaning should not exceed 45°C.
- f.) Whether cleaning is carried out manually or by machine, we especially ask you to ensure that the correct dosage for cleaning solutions or the correct combination of disinfectant and cleaning solution, is employed. Similar importance should be applied to the length of time the agents require to perform properly and to the temperature set.
- g.) Hinged instruments should be opened before cleaning.
- h.) Please ensure that the perforated instrument trays, when loaded, do not exceed 10 kg in weight.
- i.) Please take care that when instruments are being cleaned they are arranged proper in a manne that fluids can circulate freely.
- j.) Deposits remaining after the cleaning process must be completely removed in the first rinse which now follows. The optimum temperature for final rinsing has proved to be between 70° and 90° C. Please use only purified water in this final cleaning stage.
- k.) The instruments must be carefully dried after cleaning and rinsing is completed.
- l.) Moving parts and the cutting edges of shears and scissors must be treated with preservatives which are both suitable and physiologically safe.

3. TESTING FOR CORRECT FUNCTIONING

- a.) Instruments must be carefully and thoroughly checked before every occasion that they are used.

- b.) After each time they are cleaned, the instruments must be macroscopically clean, i.e., visibly free from proteinbased residues and other soiling.
- c.) Care should be taken so that cracks, breakages and corrosion are noticed.
- d.) Instruments with flecks should be separated and taken out for special treatment.
- e.) All moving parts as well as working tips and blades should be checked with special care.
- f.) Checking should be carried out according to the extent to which the instruments will be used.
- g.) Instruments which are in any way defective or damaged should be immediately sorted out from the others.

4. STERILIZATION

- a.) All stainless steel surgical instruments supplied by us may be sterilized in an autoclave.
- b.) Please follow the manufacturer's operating instructions when using autoclave. All machines used must comply with all current quality and other standards.
- c.) Instruments are being sterilized/ autoclaved at a temperature of 134°C.
- d.) Sterilization packing material must comply with all current standards.
- e.) Instruments with ratchets or self-retaining mechanisms should be sterilized opened or in the first ratchet position.
- f.) Please ensure that perforated instrument trays, when loaded do not exceed 10 kg in weight.

5. IN GENERAL

- a.) All surgical instruments supplied by us have been thoroughly inspected before dispatch and leave our factory in perfect condition. Damage which can arise as a result of transporting, cleaning, preserving, sterilizing or storing, must be prevented.
- b.) Please handle surgical instruments always with the utmost care.
- c.) Instruments must be stored in a clean and dry place.
- d.) If you have any queries or problems please contact us at any time:

We should like to point out that, if the above-mentioned directions are not followed or the instruments supplied by us are not properly used, all guarantee claims become void and any consequences must be borne by yourselves.

SUGERENCIAS PARA LA LIMPIEZA, ESTERILIZACIÓN Y MANTENIMIENTO DE INSTRUMENTOS QUIRÚRGICOS

ENJUAGADO

Tras el uso enjuagar enseguida los instrumentos bajo un chorro de agua caliente (no hirviendo). El enjuagado debe servir para quitar los residuos de sangre, mucosas y tejidos.

LIMPIEZA

Si la limpieza no se efectúa inmediatamente después del enjuagado, los instrumentos tienen que sumergirse en una solución de agua y detergente con PH neutro (7)

Para los instrumentos muy delicados (algunos tipos de porta agujas o tijeras se aconseja una limpieza manual: ver punto "C".

a.- Limpieza en la pila de ultrasonido

Los instrumentos tienen que estar en la pila el tiempo necesario recomendado por el fabricante para efectuar el ciclo del lavado, generalmente de 5 a 10 minutos.

Los instrumentos con bisagras o juntas (articulaciones) tienen que sumergirse en la pileta en posición abierta.

Asegurarse de que las hojas afiladas de las tijeras, bisturíes para gingivectomía, curetas, etc. no estén en contacto con otros instrumentos.

Todos los instrumentos deben estar completamente sumergidos en la solución de lavado.

No poner instrumentos de diferentes metales (acero inoxidable, instrumentos cromados, latón, etc.) en el mismo ciclo de lavado.

Cambiar a menudo la solución para el lavado, como mínimo todas las veces que lo recomienda el fabricante de la pileta de ultrasonidos.

Enjuagar concienzudamente los instrumentos con agua corriente tras lavado con ultrasonidos para quitar los residuos de la solución de lavado.

b.- Limpieza con lavadora

Seguir las indicaciones del fabricante. Asegurarse de que los instrumentos hayan sido lubricados tras el último ciclo de lavado y antes del ciclo de esterilización.

c.- Limpieza manual

La mayor parte de los fabricantes de instrumentos indican el lavado con los ultrasonidos como el modo mejor y más eficaz para limpiar los instrumentos quirúrgicos, especialmente los que tienen bisagras, cierres y en general articulaciones. Si la limpieza con los ultrasonidos no es posible, se aconseja usar el método siguiente:

- Usar cepillos rígidos de plástico, nylon, etc.
- Cepillar concienzudamente los instrumentos más delicados y, si es posible, enjuagar, limpiar y esterilizar estos instrumentos separadamente.
- Verificar que toda la superficie de estos instrumentos esté limpia.
- Tras haber cepillado los instrumentos, enjuagarlos bajo el chorro de agua corriente.
- Durante el enjuagado abrir y cerrar las tijeras, las pinzas hemostáticas, los porta agujas y los demás instrumentos con bisagras o juntas y asegurarse de que las partes internas de las bisagras estén perfectamente enjuagadas como la superficie externa del instrumento.

SECADO, LUBRIFICACIÓN E INSPECCIÓN

Tras las operaciones de limpieza y de enjuagado, los instrumentos quirúrgicos tienen que ser secados perfectamente.

Todos los instrumentos con juntas o bisagras (acción "metal contra metal") como tijeras, pinzas hemostáticas, porta agujas, fórceps de extracción, etc., tienen que ser lubricados. Se aconsejan lubricantes específicos para el instrumental quirúrgico. No usar aceites o lubricantes industriales.

A este punto es buena norma inspeccionar el estado de cada instrumento y verificar el funcionamiento según el uso específico. Controlar y asegurarse de que:

- Las hojas de las tijeras estén lisas de arriba abajo y de que, una vez cerradas, no hagan juego. Probar las tijeras cortando gasa muy fina. Tres cuartas parte de la hoja tienen que cortar la gasa sin retenerla.

- Las puntas de las pinzas estén al mismo nivel.

- Las pinzas hemostáticas y los porta agujas no dejen pasar la luz entre las puntas cuando estén cerradas, se abran y cierren fácilmente y que las bisagras no estén demasiado flojas.

- Controlar el desgaste de la porta agujas sobre la superficie interna de las puntas.

- Las cánulas metálicas de aspiración estén bien limpias en su interior.

- Los instrumentos cortantes y los bisturíes tengan las hojas bien afiladas y no estropeadas.

ESTERILIZACIÓN EN AUTOCLAVE

Tras haber enjuagado, limpiado, secado, lubricado e inspeccionado los instrumentos, éstos pueden ser preparados para la esterilización separadamente o en serie.

Instrumentos individuales:

Las bolsas especiales monouso son el ideal para contener los instrumentos. Asegurarse de que las bolsas que contendrán los instrumentos con cierres y articulaciones (pinzas hemostáticas, porta agujas, etc.) sean lo bastante grandes como para contener los citados instrumentos en posición abierta.

Instrumentos en serie:

Poner los instrumentos en los especiales cestos o bandejas de acero inoxidable. Poner los instrumentos más pesados en la parte inferior cuando sean necesarias varias bandejas.

No cerrar nunca los instrumentos durante el ciclo en autoclave. Un instrumento cerrado no estará nunca bien esterilizado, ya que el vapor no puede penetrar en la parte de cierre a contacto "metal contra metal". En el instrumento podría además romperse en la parte de la bisagra a causa de la expansión del metal debida al calor durante el ciclo del autoclave.

No cargar demasiado la cámara del autoclave ya que algunos instrumentos podrían formar "zonas de sombra" sobre otros en los que el vapor no penetraría.

ATENCIÓN

Al final del ciclo de esterilización - antes del ciclo de secado- abrir ligeramente la portezuela del autoclave y preceder con el ciclo desecado según las instrucciones del fabricante. Si la portezuela del autoclave se abriese completamente antes del ciclo de secado, el aire frío de la habitación entraría en la cámara del autoclave causando la formación de condensación sobre los instrumentos y de consecuencia aparecerían las manchas de agua que vemos a menudo en los mismos.

ESTERILIZACIÓN EN FRÍO:

La mayor parte de las soluciones para la esterilización en frío esterilizan los instrumentos completamente tras 10 horas de inmersión. Esta acción química prolongada puede ser más perjudicial para los instrumentos que el ciclo normal de 20 minutos en autoclave.

Si los instrumentos tienen necesidad de ser simplemente "desinfectados", el proceso en frío es adecuado, ya que la desinfección tiene lugar en 10 minutos solamente.

Recuerde bien la diferencia entre:

ESTÉRIL - término absoluto (ningún organismo logra sobrevivir) y

DESINFECTADO - perfectamente limpio.

Usen siempre la técnica más adecuada de esterilización/limpieza de los instrumentos según el uso que se haga posteriormente de ellos.

Recuerden que la esterilización de los instrumentos no sustituye la limpieza de los mismos.

Recomendamos no volver a usar ni esterilizar los artículos de un solo uso.

Si se tratan en el modo correcto los instrumentos contruidos con las modernas aleaciones inoxidables pueden durar muchos años.

REINIGUNG, PFLEGE UND STERILISATION
CLEANING, CARE AND STERILIZATION
LIMPIEZA, MANTENIMIENTO Y ESTERILIZACION

ENDOSKOPE 13 - 20
ENDOSCOPES
ENDOSCOPIOS

STIRNLAMPEN 21 - 28
HEAD LIGHTS
LÁMPARAS FRONTALES

BOHRER 29 - 32
BURRS
BROCAS

HOCHFREQUENZ-CHIRURGIE 33 - 46
HIGH FREQUENCY SURGERY
CIRUGIA DE ALTA FRECUENCIA

OTOLOGIE UND OHR-MIKROCHIRURGIE 47 - 138
OTOLOGY AND EAR MICROSURGERY
OTOLOGÍA Y MICRO CIRUGIA PARA OIDO

RHINOLOGIE - SINUSKOPIE 139 - 266
RHINOLOGY - SINUSCOPY
RINOLOGÍA - SINUSCOPIA

ADENOTOMIE UND TONSILLEKTOMIE 267 - 312
ADENOTOMY AND TONSILLECTOMY
ADENOTOMÍA Y TONSILECTOMÍA

TRACHEOTOMIE 313 - 320
TRACHEOTOMY
TRAQUEOTOMÍA

LARYNGOSKOPIE UND ENDOLARYNGEALE MIKROCHIRURGIE 321 - 354
LARYNGOLOGY AND ENDOLARYNGEAL MICROSURGERY
LARINGOSCOPIA Y MICRO CIRUGIA ENDOLARINGEAL

BRONCHOSKOPIE 355 - 356
BRONCHOSCOPY
BRONCOSCOPIA

INSTRUMENTENSÄTZE 357- 372
INSTRUMENT SETS
JUEGOS DE INSTRUMENTOS

NUMMERNVERZEICHNIS 373 - 384
NUMERICAL INDEX
INDICE NUMERICO

ALPHABETISCHER INDEX 385 - 419
ALPHABETICAL INDEX
INDICE ALFABETICO

Reda Instrumente GmbH
Gänsäcker 34 - P.O. Box 131
D-78532 Tuttlingen



ENDOSKOPE

ENDOSCOPES

ENDOSCOPIOS



www.Reda-Instrumente.de

Indikationen und Kontraindikationen finden Sie in der entsprechenden Gebrauchsanweisung!

Indication and Contraindication please refer to our user`s manual!

Indicaciones y Contraindicaciones se encuentran en la instrucciones de uso correspondientes!

Ultra-slim Nasolaryngoskop
 Ultra-slim Nasolaryngoscope
 Nasolaringoscopio Ultra-slim



R805-130402-034

300 mm Nutzlänge / working length / largo útil

3,4 mm Durchmesser / diameter / diametro

130°	aufwärts / abwärts up / down hacia arriba / hacia abajo	Schwenkbereich des distalen Endes Bending range of distal tip distal final girable
------	---	--

0°	Blickwinkel / direction of view / direccion de vista
----	--

Endoskope / Optische Zange
Endoscopes / Optical Forceps
Endoscopios / Pinza optica

autoklavierbar / autoclavable / autoclavable
max. 134°C, 2,3 bar

Sinuskop - Sinuscope - Sinuscopio

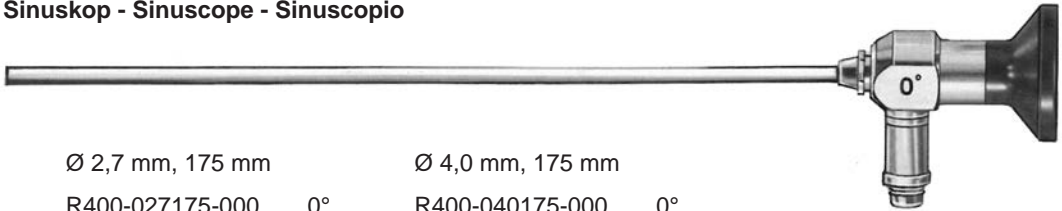

Ø 2,7 mm, 175 mm

R400-027175-000 0°
R400-027175-030 30°
R400-027175-070 70°

Ø 4,0 mm, 175 mm

R400-040175-000 0°
R400-040175-030 30°
R400-040175-045 45°
R400-040175-070 70°

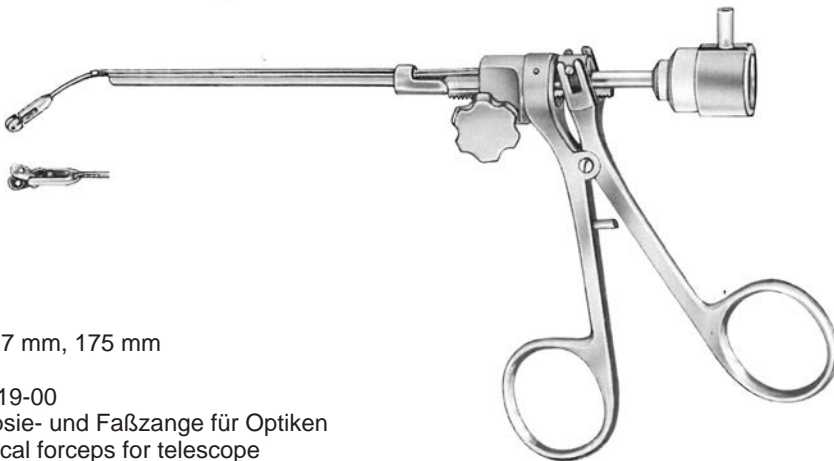

Ø 2,7 mm, 175 mm

47319-00
Biopsie- und Faßzange für Optiken
Optical forceps for telescope
Pinza optica de biopsia y agarre

Endoskope
Endoscopes
Endoscopios

autoklavierbar / autoclavable / autoclavable
max. 134°C, 2,3 bar

Pharyngoskop - Pharyngoscope - Faringoscopio

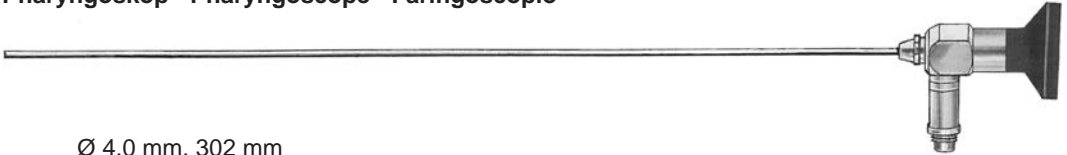

Ø 4,0 mm, 302 mm

R300-040302-000	0°
R300-040302-030	30°
R300-040302-070	70°

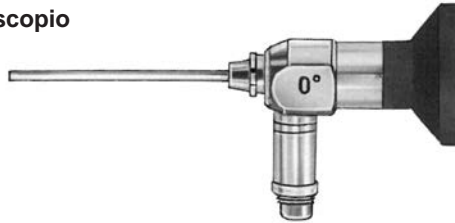
autoklavierbar / autoclavable / autoclavable
max. 134°C, 2,3 bar**Otoskop - Otoscope - Otoscopio**

Ø 2,7 mm, 41 mm

R501-027041-000 0°

R501-027041-030 30°

Ø 4,0 mm, 50 mm

R501-040050-000 0°

R501-040050-030 30°

Laryngoskop - Laryngoscope - Laringoscopio

Ø 10 mm, 147,5 mm

R503-100148-070 70°

Ø 11 mm, 145 mm

R503-110145-090 90°

Ø 10 mm, 173 mm

R503-100173-070 70° mit Lichtleiter / integrated light cable / con portador de luz

Ø 11 mm, 173 mm

R503-110173-090 90° mit Lichtleiter / integrated light cable / con portador de luz

Endoskope
Endoscopes
Endoscopios

autoklavierbar / autoclavable / autoclavable
max. 134°C, 2,3 bar

Endoskop zur endolaryngealen Mikrochirurgie
Endoscope for endolaryngeal microsurgery
Endoscopio para microcirurgia endolaringeal

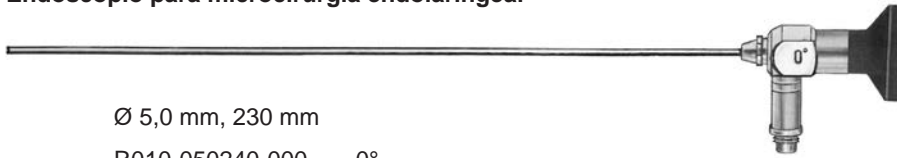

Ø 5,0 mm, 230 mm

R010-050240-000	0°
R010-050240-030	30°
R010-050240-070	70°

Bronchoskop - Bronchoscope - Broncoscopio

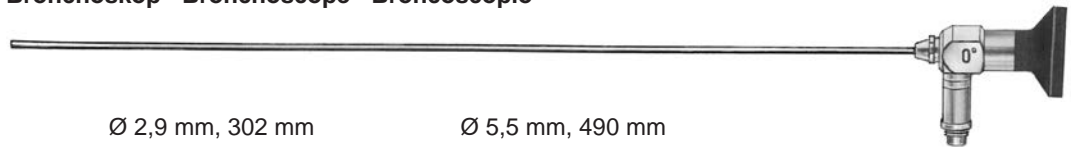

Ø 2,9 mm, 302 mm

R010-030302-000	0°
R010-030302-030	30°

Ø 5,5 mm, 490 mm

R010-055490-000	0°
R010-055490-030	30°

Fiberglas-Lichtkabel ohne Adapter
Light Guide Cables without Adapters
Cable de fibra optica sin adaptadores



verklebt für Halogen Licht bonded for Halogen Light para luz halogena	Ø	cm	verschmolzen für Xenon Licht fused for Xenon Light para luz Xenon
R900-035180-00	3,5	180	R901-035180-00
R900-035230-00	3,5	230	R901-035230-00
R900-035300-00	3,5	300	R901-035300-00
R900-035350-00	3,5	350	R901-035350-00
R900-048180-00	4,8	180	R901-048180-00
R900-048230-00	4,8	230	R901-048230-00
R900-048250-00	4,8	250	R901-048250-00
R900-048300-00	4,8	300	R901-048300-00
R900-048350-00	4,8	350	R901-048350-00

Adapter
Adapters
Adaptadores



Adapter zu Lichtquelle
Adapters to light source
Adaptador a la fuente de luz

INNEN - IN - INTERIOR



R900-000000-01
Storz / Aesculap

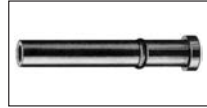

R900-000000-11
Fuji



R900-000000-03
Wolf / Henke Sass /
Dyonics / Medicon /
Comeg

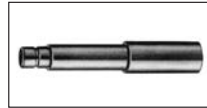

R900-000000-13
Heine-Optotechnik

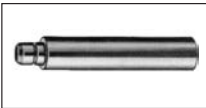

R900-000000-05
ACM / British /
Codman

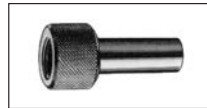

R900-000000-15
Winter+IBE



R900-000000-07
Olympus



R900-000000-21
MLW



R900-000000-09
Pentax



R900-000000-31
Volpi / Schöilly /
RFO



Adapter zu Endoskope
Adapter to Endoscope-side
Adaptador al endoscopio

AUSSEN - OUT - EXTERIOR



R900-000000-02
Storz / Winter+IBE /
Aesculap / Olympus



R900-000000-06
ACM / British /
Codman



R900-000000-04
Wolf

Reda Instrumente GmbH
Gänsäcker 34 - P.O. Box 131
D-78532 Tuttlingen



STIRNLAMPEN

HEAD LIGHTS

LÁMPARAS FRONTALES



www.Reda-Instrumente.de

Indikationen und Kontraindikationen finden Sie in der entsprechenden Gebrauchsanweisung!

Indication and Contraindication please refer to our user's manual!

Indicaciones y Contraindicaciones se encuentran en la instrucciones de uso correspondientes!

Nystagmusbrille
Nystagmus Spectacles
Anteojos para nistagmo



FRENZEL

03167-03

Beleuchtete Nystagmusbrille
mit querliegendem Batterie-
handgriff und festen Gläsern

03167-03

Nystagmus Spectacles for
observation of the eyes during
examination of the vestibular
apparatus, with battery handle
and fixed glasses. Illuminated
on inside of lenses.

03167-03

Anteojos para nistagmo, con
iluminación, con mango para
pilas en forma horizontal,
vidrios fijos,

Energiequelle:

2 Stück 4-Volt-Lämpchen
2 Stück Baby-Zellen 1.5 V

Source of energy:

2 bulbs 4-volt
2 baby-battery cells 1.5 V

Alimentación:

2 unidades de bombillas de
4 voltios
2 unidades de pilas de
1.5 voltios



03165-07

Ersatzlampe
Spare bulb
Bombilla de repuesto

Stirnspiegel
Head Mirror
Espejos frontales



03180-93
ø 90 mm



ZIEGLER
03180-90
compl.



03180-92

03180-90
Ziegler-Stirnspiegel,
komplett, mit schwarzem
Stirnreifen,
mit Kugelgelenk,
90 mm ø

03180-90
Ziegler Head Mirror,
complete with black head
band, with ball socket,
90 mm ø

03180-90
Ziegler espejo frontal,
completo con cinta negra,
con articulación,
90 mm ø

03180-92
Stirnreifen, allein

03180-92
head band, only

03180-92
cinta, suelta

03180-93
Spiegel, allein
90 mm ø

03180-93
Mirror, only
90 mm ø

03180-93
Espejo, suelto
90 mm ø

HNO Stirnleuchte
Miniature Headlight
Lampara frontal mini



03192-00

Fiberoptische Miniaturstirnleuchte für den OP-Bereich. Miniatur-Hochleistungs-Optik, Faserbündel- \varnothing 3,5 mm, heller / homogener Lichtfleck, ledergepolstertes Stirnband mit seitlichen Kopfstützen und Stellrad. Lieferung ohne Adapter für Lichtquelle.

03192-00

Fibre Optic miniature headlight for operation theatre. Perfect view by very small optic. The fibre bundle diameter of 3.5 mm and the double lens system effects a small and homogenous light spot with lateral head supports. Easily adjustable by hand wheel. Supplied without adapter for light source.

03192-00

Frontal de luz fría para profunda e intensiva iluminación. El cable de fibra optica de 3,5 mm de diametro y su sistema de doble lente ofrece una iluminacion clara y homogénea haz de luz con soportes laterales. Facilmente ajustable con el sistema de rueda. Suministrado sin adaptador para fuente de luz.



03192-01

wie 03192-00, aber Projektorseite 90°
same as 03192-00, but projector side 90° angled
como 03192-00, pero terminal para proyector angulado en 90°



03193-20

Adapter
Adapter
Adaptador

HNO Stirnleuchte, Kaltlicht
Headlight Microfocus, Fibre Optic
Lampara frontal mini, luz fria



03193-00

Stirnlampe mit stufenlos variablem Mikrofokus zur blendfreien Tiefenausleuchtung. Durch kleinen Lichtaustritt und verstellbarer Kleinoptik optimales Sichtfeld. Komplett mit 2,2 m F/O-Kabel (Faserbündel- \varnothing 3,5 mm) und ledergepolstertem Kopfbügel-Stirnreif. Ohne Adapter für Lichtquelle.

03193-00

Headlight with stepless variable micro focus for intensive depth illumination. Very small focus. 2.2 m F/O cable (fibre bundle \varnothing 3.5 mm). Ergonomic and leather padded headband with crossband. Supplied without adapter for light source.

03193-00

Frontal de luz con focus variable y progresion continua con cable de 2,2 m largo y 3,5 mm de diámetro. Cabezal recubierto de piel e ergonómico. Se suministra sin adaptador para fuente de luz.



03193-01

wie 03193-00, aber Projektorseite 90°
same as 03193-00, but projector side 90° angled
como 03193-00, pero terminal para proyector angulado en 90°



03193-20

Adapter
Adapter
Adaptador

Stirnlampe
Head Light
Lámpara frontal



CLAR
03195-00

komplett mit Stirnstreifen und Kabel
complete with head band and cable
completo con cinta frontal y cable



03195-01
ø 55 mm



03195-06
6 Volt

Spiegel aus Glas ohne Fassung
Glass Mirror without frame
Reflector de cristal, sin montura



03195-07 Kleintransformator
220 Volt = 0 - 10 Volt / 3 Watt
Mini-Transformer Unit
Transformador eléctrico pequeño

03195-08 Kleintransformator
110 Volt = 0 - 10 Volt / 3 Watt
Mini-Transformer Unit
Transformador eléctrico pequeño

Stirnlampe
Head Light
Lámpara frontal

03194-00

Xenon Stirnlampe mit Batteriebox
Xenon headlight with battery box
Lámpara frontal Xenon con caja para batería



03194-01

Ersatzlampe mit Reflektor
Spare lamp with reflector
Lámpara de repuesto con reflector

03196-00

Kabellose OP-LED-Stirnleuchte,
schwarz, mit Kopfbügel und Akku

Wireless OT-LED-Headlight,
black, with headband

Lámpara frontal LED, inalám-
brica, negra con cinta y batería



Reda Instrumente GmbH
Gänsäcker 34 - P.O. Box 131
D-78532 Tuttlingen



BOHRER

BURRS

BROCAS



www.Reda-Instrumente.de

Indikationen und Kontraindikationen finden Sie in der entsprechenden Gebrauchsanweisung!
Indication and Contraindication please refer to our user's manual!
Indicaciones y Contraindicaciones se encuentran en la instrucciones de uso correspondientes!

Bohrer 70 mm, Schaft 2,35 mm
 Burrs, 70 mm, Shaft 2.35 mm
 Brocas, 70 mm, vástago 2,35 mm



Edelstahl
Stainless steel
Inoxidable



Diamant
Diamond
Diamante

Ø 0,60 mm	50236-06	
Ø 0,70 mm		50242-07
Ø 0,80 mm	50236-08	50242-08
Ø 1,00 mm	50236-10	50242-10
Ø 1,40 mm	50236-14	
Ø 1,50 mm		50242-15
Ø 1,80 mm	50236-18	50242-18
Ø 2,00 mm		50242-20
Ø 2,30 mm	50236-23	50242-23
Ø 2,50 mm		50242-25
Ø 2,70 mm		50242-27
Ø 3,00 mm		50242-30
Ø 3,10 mm	50236-31	
Ø 3,50 mm	50236-35	50242-35
Ø 4,00 mm	50236-40	50242-40
Ø 4,50 mm	50236-45	50242-45
Ø 5,00 mm	50236-50	50242-50
Ø 6,00 mm	50236-60	50242-60
Ø 7,00 mm	50236-70	50242-70

Bohrer 70 mm, Schaft 2,35 mm
 Burrs, 70 mm, Shaft 2.35 mm
 Brocas, 70 mm, vástago 2,35 mm



Hartmetall
Tungsten Carbide
Tungsteno

Hartmetall grob
Tungsten Carbide coarse
Tungsteno grueso

Ø 0,60 mm	50237-06	
Ø 0,70 mm		
Ø 0,80 mm	50237-08	
Ø 1,00 mm	50237-10	
Ø 1,40 mm	50237-14	
Ø 1,50 mm		
Ø 1,80 mm	50237-18	
Ø 2,00 mm		
Ø 2,30 mm	50237-23	
Ø 2,50 mm	50237-25	
Ø 2,70 mm	50237-27	
Ø 3,00 mm	50237-30	
Ø 3,10 mm		
Ø 3,50 mm	50237-35	50238-35
Ø 4,00 mm	50237-40	50238-40
Ø 4,50 mm	50237-45	50238-45
Ø 5,00 mm	50237-50	50238-50
Ø 6,00 mm	50237-60	
Ø 7,00 mm	50237-70	



Reda Instrumente GmbH
Gänsäcker 34 - P.O. Box 131
D-78532 Tuttlingen

**HOCHFREQUENZ-
CHIRURGIE**

**HIGH FREQUENCY
SURGERY**

**CIRUGIA DE ALTA
FRECUENCIA**



www.Reda-Instrumente.de

Indikationen und Kontraindikationen finden Sie in der entsprechenden Gebrauchsanweisung!
Indication and Contraindication please refer to our user's manual!
Indicaciones y Contraindicaciones se encuentran en la instrucciones de uso correspondientes!

Hochfrequenz-Chirurgie
High Frequency Surgery
Electrocirugía

Mindestbestellmenge 10
Minimum order quantity 10
Cantidad minima 10



91010-01
Fig. 1



91010-02
Fig. 2 45°



91010-03
Fig. 3 120°



91010-11
Fig. 11
Ø 3 mm



91010-12
Fig. 12
Ø 5 mm



91010-13
Fig. 13
Ø 8 mm



91010-14
Fig. 14



91010-15
Fig. 15 45°
7,0x1,5 mm



91010-16
Fig. 16 45°
7 mm



91010-17
Fig. 17
6,0x1,3 mm



91010-18
Fig. 18 30°
7,0x1,7 mm



91010-21
Fig. 21
7,0x1,7 mm



91010-31
Fig. 31 45°
Ø 0,6 mm



91010-33
Fig. 33 45°
Ø 1,7 mm



91010-34
Fig. 34 45°
Ø 3,0 mm



91010-35
Fig. 35



91010-36
Fig. 36 90°

Schaft
shaft
vástago
Ø 2,4 mm

Mindestbestellmenge 10
 Minimum order quantity 10
 Cantidad minima 10

Hochfrequenz-Chirurgie
 High Frequency Surgery
 Electrocirugía



91011-51
 Fig. 51 45°
 Ø 3 mm



91011-52
 Fig. 52 45°
 7,0x1,7 mm



91011-53
 Fig. 53 45°



91011-54
 Fig. 54



91011-55
 Fig. 55



91011-56
 Fig. 56 45°
 Ø 5 mm



91011-61
 Fig. 61 45°



91011-62
 Fig. 62 90°

Schaft
 shaft
 vástago
 Ø 2,4 mm

Serie STANDARD



91020-01



91020-02

Schaft
 shaft
 vástago
 Ø 4 mm



91020-03



91020-04



Ø mm
 5 91022-05
 10 91022-10
 20 91022-20



Ø mm
 10 91024-10
 15 91024-15
 20 91024-20



Ø mm
 2 91030-02
 4 91030-04
 6 91030-06

Schaft
 shaft
 vástago
 Ø 4 mm

Bipolare Koagulation
 Bipolar Coagulation
 Coagulación bipolar



91102-11
 11 cm, 4 3/8"



91104-11
 11 cm, 4 3/8"



91109-11
 11 cm, 4 3/8"
 45°
 0.5 mm



91113-11
 11 cm, 4 3/8"
 45°
 0.5 mm



91115-11
 11 cm, 4 3/8"
 45°
 0.5 mm



91122-16
 16,5 cm, 6 1/2"
 0.5 mm



91123-16
 16,5 cm, 6 1/2"
 0.5 mm



91124-16
 16,5 cm, 6 1/2"
 1 mm



91125-16
 16,5 cm, 6 1/2"
 0.5 mm



91127-16
 16,5 cm, 6 1/2"
 1 mm

Bipolare Koagulation
Bipolar Coagulation
Coagulación bipolar



91142-16
16,5 cm, 6 1/2"
1 mm



91144-16
16,5 cm, 6 1/2"
0.5 mm



91146-16
16,5 cm, 6 1/2"
1 mm



91152-19
19,5 cm, 7 3/4"
0.3 mm



91154-19
19,5 cm, 7 3/4"
1 mm



91157-19
19,5 cm, 7 3/4"
1 mm



91159-19
19,5 cm, 7 3/4"
2 mm

Bipolare Koagulation
 Bipolar Coagulation
 Coagulación bipolar



91162-19
 19,5 cm, 7 3/4"
 0.3 mm



91164-19
 19,5 cm, 7 3/4"
 1 mm



91166-19
 19,5 cm, 7 3/4"
 2 mm



91167-19
 19,5 cm, 7 3/4"
 1 mm



91169-19
 19,5 cm, 7 3/4"
 1 mm



91172-03 - 91172-12
 22,5 cm, 8.9"



91172-03
 0,3 mm









91172-07
 0,7 mm



91172-12
 1,2 mm

Unit side

Instrument side

	Cable length Meter	Flat plug europe	
			
Erbe / Storz 12,5 mm Ø 	3	R065-040125-003	R065-040125-103
	5	R065-040125-005	R065-040125-105
Martin / Berchtold 8 mm Ø AESCULAP Wolf 	3	R065-020080-003	R065-020080-103
	5	R065-020080-005	R065-020080-105
Valleylab / Lamidey / EMC 	3	R065-040285-003	R065-040285-103
	5	R065-040285-005	R065-040285-105
2-Pin U.S. Standard Eschmann 	3	R065-040000-003	R065-040000-103
	5	R065-040000-005	R065-040000-105

Bipolare Koagulation
Bipolar Coagulation
Coagulación bipolar

NON STICK

gerade
straight
recta



	0,3 mm	0,5 mm	1,0 mm	2,0 mm
11,0 cm, 4 3/8"	91110-03N	91110-05N	91110-10N	
16,0 cm, 6 1/4"	91160-03N	91160-05N	91160-10N	91160-20N
18,0 cm, 7"		91180-05N	91180-10N	91180-20N
19,5 cm, 7 3/4"		91200-05N	91200-10N	91200-20N
22,0 cm, 8 3/4"			91220-10N	91220-20N
24,0 cm, 9 1/2"			91240-10N	
30,0 cm, 12"			91300-10N	91300-20N

abgewinkelt 45°
angled 45°
angulada 45°



	0,3 mm	0,5 mm	1,0 mm	2,0 mm
11,0 cm, 4 3/8"	91112-03N	91112-05N	91112-10N	
16,0 cm, 6 1/4"		91162-05N	91162-10N	
18,0 cm, 7"			91182-10N	91182-20N
19,5 cm, 7 3/4"		91202-05N	91202-10N	91202-20N
22,0 cm, 8 3/4"			91222-10N	91222-20N
24,0 cm, 9 1/2"			91242-10N	

NON STICK

Bipolare Koagulation
Bipolar Coagulation
Coagulación bipolar

bayonett gerade
bayonet straight
bayoneta recta



	0,3 mm	0,5 mm	1,0 mm	2,0 mm
16,0 cm, 6 ¼"	91166-03N	91166-05N	91166-10N	91166-20N
19,5 cm, 7 ¾"		91206-05N	91206-10N	91206-20N
22,0 cm, 8 ¾"		91226-05N	91226-10N	91226-20N
24,0 cm, 9 ½"		91246-05N	91246-10N	91246-20N

bayonett nach oben
bayonet upwards
bayoneta hacia arriba



	1,0 mm
19,5 cm, 7 ¾"	91207-10N
22,0 cm, 8 ¾"	91227-10N

bayonett nach unten
bayonet downwards
bayoneta hacia abajo



	0,5 mm	1,0 mm
16,0 cm, 6 ¼"	91168-05N	91168-10N
19,5 cm, 7 ¾"		91208-10N
22,0 cm, 8 ¾"		91228-10N

Bipolare Saugpinzetten
Bipolar Suction Forceps
Pinza de succión bipolar

Saugpinzetten zum Absaugen von Blut und Sekret vor der Koagulation bzw. zum Absaugen von Rauch während der Koagulation.

Europäischer Flachstecker zum Anschluß von bipolaren Kabeln für praktisch alle gebräuchlichen HF-Generatoren.

Der Saugkanal mit Unterbrecherloch ist in einem Schenkel der Pinzette integriert.

An der Schlaucholive können verschiedene Schlauchdurchmesser angeschlossen werden.

Suction forceps for extraction of blood and debris by suction right before coagulation or extraction of smoke while coagulating.

European flat socket connector for bipolar cables for nearly all common high frequency generators.

Suction channel integrated inside the forceps.

Suction connector matches different suction tube diameters.



91201-20S



Pinza de succión para sangre y líquidos antes de efectuar la coagulación como también para la eliminación de humo durante la coagulación.

Enchufe plano europeo para conectar cables bipolares de equipos de alta frecuencia en uso corrientemente.

El canal de succión con su agujero de interrupción está incorporado en un lado de la pinza.

El diseño de la oliva de conexión permite la adaptación de tubos de varios diámetros.

Monopolar Saugkoagulator
Monopolar Suction Coagulator
Coagulador de succión monopolar antiadherente

NON STICK

gerade, biegsam
straight, malleable
recta, maleable



91179-18N
18 cm, 7"

Bipolare Stichkoagulationselektrode
Bipolar Stitch Coagulation Electrodes
Electrodos de coagulación de puncion, bipolar



91176-19
19 cm, 7 1/2"
20°



91177-20
19,5 cm, 7 3/4"
55°



Bipolare Koagulationselektrode MICRODOME
Bipolar Coagulation Elektrode MICRODOME
Electrodo de coagulación bipolar MICRODOME

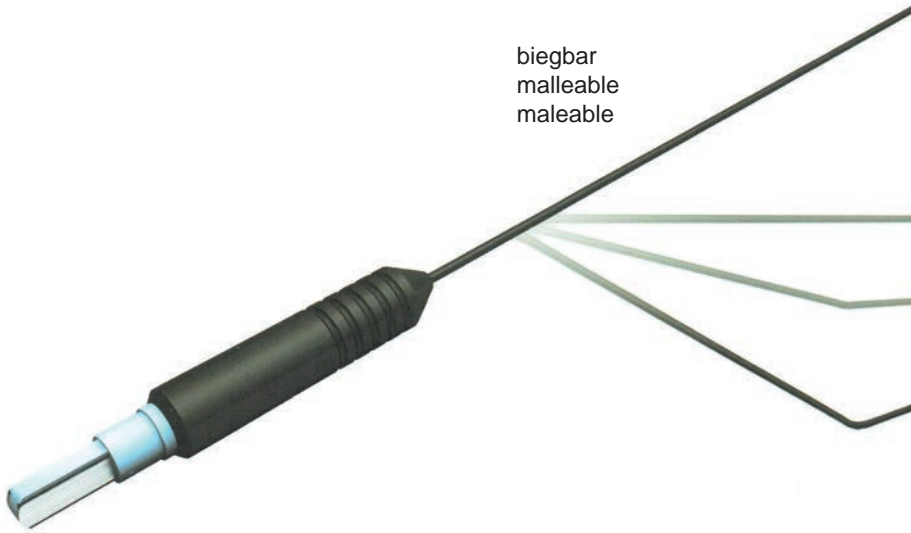

biegbar
malleable
maleable

91178-14
14 cm, 5 ½"

Reda Instrumente GmbH
Gänsäcker 34 - P.O. Box 131
D-78532 Tuttlingen



OTOLOGIE

OTOLOGY

OTOLOGÍA



www.Reda-Instrumente.de

Indikationen und Kontraindikationen finden Sie in der entsprechenden Gebrauchsanweisung!
Indication and Contraindication please refer to our user`s manual!
Indicaciones y Contraindicaciones se encuentran en la instrucciones de uso correspondientes!

Diagnostik-Bestecke mit Standardbeleuchtung
Diagnostic Sets with Standard Illumination
Estuches de diagnóstico con iluminación standard

UNI I



Nr. 03161-00

Weltbekanntes und preiswertes Otoskop mit Standardbeleuchtung 2,5 V. Besonders geeignet für Studenten und Ärzte.
Set bestehend: Aus **Otoskopkopf** verchromt, mit Steckverschluß. **Verchromter Batteriegriff 28 mm ø** für 2 Batterien Typ C. Mit abnehmbarem Abdeckglas in Kunststoff-Fassung mit Plastikconnector für den pneumatischen Test. Die verchromte Schwenklinse ist abnehmbar und vergrößert 4,0-fach. Die Lichtstärke kann anhand des Rheostates reguliert werden. Mit 3 wiederverwendbaren Ohrtrichtern 2, 3 und 4 mm ø. Komplett in silberfarbener Kunststofftasche.

No. 03161-00

World famous otoscope set at a budget price for physicians and students. 2,5 V standard illumination for use with 2 batteries type C.

Set includes: **Otoscope head** with pin contact fitting. Chrome-plated. Fixed protective lens in plastic mount may be removed for introduction of instruments. Plastic connector for pneumatic otoscopy. Removable swivel-mounted 4 x magnifier. 2, 3 and 4 mm reusable specula included. **Battery handle 28 mm ø** for 2 C-cell batteries. Chrome-plated. With thumb wheel for securing pin contact heads. With rheostat for adjustment of illumination. Complete in silver-colored plastic pouch.

No. 03161-00

Otoscopio muy popular y económico con iluminación standard 2,5 V apropiado para estudiantes y médicos, de fama mundial.

Cabeza otoscopio cromada, con cierre de tornillo. **Mango a pilas cromado 28 mm ø** para dos pilas tipo C. Con cristal de cubierto desmontable en armadura plástica. Con conector plástico para el test neumático. La lente giratoria es desmontable y amplifica 4,0 veces mas. La intensidad de la luz es regulable con el reostato. Con tres espejos reutilizables 2, 3 y 4 mm ø. Completo en bolsa de plástico de color gris plata.

Diagnostik-Bestecke mit Standardbeleuchtung
Diagnostic Sets with Standard Illumination
Estuches de diagnóstico con iluminación standard

UNI II



Nr. 03161-01

Weltbekanntes und preisgünstiges **May-Ophthalmoskop**: mit Standardbeleuchtung 2,5 V. Besonders für Studenten und Ärzte geeignet. Ophthalmoskop mit Steckverschluß. Anhand des Linsenrades können Korrekturlinsen von 0 bis +20 und 0 bis -20 Dioptrien gewählt werden. Mit einer Blende: großer Kreis. Mit verchromtem **Batteriegriff**: 28 mm ø für 2 Batterien Typ C. Die Lichtstärke kann anhand des Rheostates reguliert werden. Komplett in silbergrauer Kunststofftasche.

No. 03161-01

World-famous ophthalmoscope set at a budget price for physicians and students. 2,5 V standard illumination for use with 2 batteries Type C. Set includes: **May ophthalmoscope head**: Pin contact fitting. Lens selection wheel permits choice of corrective lenses from 0 to +20 and 0 to -20 diopters. Single large circle aperture. **Battery handle**: 28 mm ø for 2 C-cell batteries. Chrome-plated. With thumb wheel for securing pin-contact heads. Rheostat for adjustment of illumination. Complete in silver-gray plastic pouch.

No. 03161-01

Oftalmoscopio May: muy popular y económico con iluminación standard 2,5 V, apropiado para estudiantes y médicos de fama mundial. Oftalmoscopio con cierre de tornillo. Con ayuda de la rueda de lentes se puede elegir lentes de corrección de 0 a +20 y 0 a -20 dioptrías. Y con una apertura: gran círculo. Con **mango a pilas**: cromado 28 mm ø para dos pilas tipo C. La intensidad de la luz es regulable con el reostato. Completo en bolsa de plástico de color gris plata.

Diagnostik-Bestecke mit Standardbeleuchtung
Diagnostic Sets with Standard Illumination
Estuches de diagnóstico con iluminación standard

UNI III



Nr. 03161-02

Weltbekanntes diagnostisches Besteck mit Standardbeleuchtung 2,5 V. Äußerst beliebt und sehr preiswert. Besonders geeignet für Studenten und Ärzte. Das Set besteht aus folgenden Teilen: **Otoskopkopf** verchromt, mit Steckverschluß. Abnehmbares Abdeckglas in Kunststofffassung, mit Plastikconnector für pneumatischen Test. Abnehmbarer Schwenklinse (Vergrößerung 4,0-fach). 3 wiederverwendbaren Ohrtrichtern 2, 3 und 4 mm ø. **May-Ophthalmoskop** mit Steckverschluß. Anhand des Linsenrades können Korrekturlinsen von 0 bis +20 und 0 bis -20 Dioptrien gewählt werden. Mit einer Blende: großer Kreis. **Batteriegriff** verchromt, 28 mm ø für 2 Batterien Typ C. Die Lichtstärke kann anhand des Rheostates am Batteriegriff reguliert werden. Alle Teile komplett in silbergrauer Kunststofftasche.

No. 03161-02

World-famous otoscope/ophthalmoscope diagnostic set at a budget price for physicians and students. 2,5 V Standard illumination for use with 2 batteries type C. Set includes: **Otoscope head** - Pin contact fitting. Chrome-plated. Fixed protective lens in plastic mount may be removed for introduction of instruments. Plastic connector for pneumatic otoscopy. Removable swivel-mounted 4 x magnifier. 2, 3 and 4 mm reusable specula included. **May ophthalmoscope head**. Pin contact fitting. Lens selection wheel permits choice of corrective lenses from 0 to +20 and 0 to -20 diopters. Single large circle aperture. **Battery handle**. 28 mm ø for 2 C-cell batteries. Chrome-plated. With thumb wheel for securing pin-contact heads. Rheostat for adjustment of illumination.

No. 03161-02

Este estuche de diagnóstico con iluminación standard 2,5 V es muy popular y muy económico, apropiado para estudiantes y médicos. Juego, compuesto de: **Cabeza otoscopio** cromado, con cierre de tornillo. Con cristal de cubierto en armadura plástica, con conector plástico para el test neumático. Con lente giratorio desmontable (amplificación: 4 veces más). **Cabeza oftalmoscopio May** con cierre de tornillo. Con ayuda de la rueda de lentes se puede elegir lentes de corrección de 0 a +20 y 0 a -20 dioptrías. Con una apertura: gran círculo. **Mango a pilas** cromado, 28 mm ø para dos pilas tipo C. La intensidad de la luz es regulable con el reostato al tope del mango. Todos los partes se presentan en una bolsa plástica de color gris plata.

Diagnostik-Bestecke mit Standardbeleuchtung
Diagnostic Sets with Standard Illumination
Estuches de diagnóstico con iluminación standard



ECO "T" 03161-03T

- a) Otoskop, mit Schraubverschluss und 3 Ohrtrichtern, 2-3-4 mm
Otoscope with screw fitting and 3 ear speculas with, 2-3-4 mm
Otoscopio, con cierre a tornillo y con 3 espéculos auriculares de 2-3-4 mms
- b) Ophthalmoskop, 0 bis +20 und 0 bis -20 Dioptrien, mit Schraubverschluss
Ophthalmoscope from 0 to +20 and 0 to -20 dioptres with screw fitting
Ofthalmoscopio, 0 a + 20 y 0 a - 20 dioptrías, con cierre a tornillo
- c) Nasenspekulum
Nasal Speculum
Espéculo nasal
- d) Lampenträger mit Schraubverschluss
Bent arm illuminator with screw fitting
Porta-lámpara, con cierre a tornillo
- e) 2 Kehlkopfspiegel No. 3 und 4
2 laryngeal mirrors no. 3 and 4
Espejos laringeos Nos. 3 y 4
- f) Mundspatelhalter
Tongue blade holder
Abaja-lenguas
- g) Batteriegriff für 2 Batterien mit Schraubverschluss (ohne Batterien)
Battery handle for 2 batteries
Mango para 2 pilas, con cierre a tornillo (sin pilas)
- h) Ersatzlämpchen 2.5 V
Spare lamp 2.5 V
Bombillo de repuesto 2.5 V

ECO "C" 03161-03C

Inhalt gleich wie oben, mit drehbarem Schnellverschluss.
Contens same as above, but with quick plug-in connector.
Mismo contenido como arriba pero con CIERRE RAPIDO GIRATORIO.

Diagnostik-Bestecke mit Xenonbeleuchtung
Diagnostic Sets with Xenon Illumination
Estuches de diagnóstico con iluminación Xenon



RI-MINI

Kleine, sehr moderne Qualitätsinstrumente aus Kunststoff, grau, mit Xenonbeleuchtung XL 2,5 V. Sehr preiswert und aufgrund der Größe besonders gut für die Arzttasche geeignet. Schraubverschluss. **Otoskop:** Fiber-Optik. Anschluß für pneumatischen Test. Lupe vergrößert 2,5-fach. Batteriegriff für 2 Batterien Typ AA. **Ophthalmoskop:** Korrekturlinsen: 0 bis +20 und 0 bis -20 Dioptrien. Blenden: Kreis groß + klein, Halbkreis, Fixierstern und Grünfilter. Griff für 2 Batterien Typ AA. Das Otoskop- und das Otoskop/Ophthalmoskop-Besteck werden jeweils mit einem Metallkonnector für pneumatischen Test und Plastikröhrchen mit jeweils 5 wiederverwendbaren Ohrtrichtern 2,5 und 4,0 mm geliefert. Komplett in modernem schwarzen Kunststoffetui.

Nr. 03171-00 - Otoskop mit Griff AA.

Nr. 03171-01 - Ophthalmoskop mit Griff AA.

Nr. 03171-02 - Otoskop/Ophthalmoskop jeweils mit Griff AA.

Economically priced state-of-the-art quality instrument made of plastics, gray color, with Xenon illumination XL 2,5 V. Due to its small size it is most suitable for each practitioner's bag. **Otoscope:** Fiber optic. Screw type fitting. 2,5 x magnifying glass. Battery handle for 2 AA-cell batteries. **Ophthalmoscope:** Corrective lenses ranging from 0 to +20 and 0 to -20 diopters. Apertures: large and small circle, semi-circle, fixation star and green filter. Otoloscope and otoscope/ophthalmoscope set each contain a metal connector for pneumatic otoscopy as well as plastic tube with 5 each reusable ear specula 2,5 and 4,0 mm. All sets come in modern black plastic case.

No. 03171-00 - Otoloscope with AA-handle.

No. 03171-01 - Ophthalmoscope with AA-handle.

No. 03171-02 - Otoloscope/ophthalmoscope with 1 each AA-handle.

Instrumentos de calidad, muy moderno y pequeño de plástico resistente, gris, con iluminación Xenon XL 2,5 V. Muy económico y gracias al tamaño apropiado para el bolsillo del médico. Cierre roscado. **Otoscopio:** fibra óptica. Conexión para test neumático. Lupa aumenta 2,5 veces más. Mango a pilas para 2 pilas, tipo AA. **Oftalmoscopio:** Lentes de corrección: 0 hasta +20 y 0 hasta -20 dioptrías. Aberturas: círculo grande y pequeño, semicírculo, estrella fijadora y filtro verde. Con mango para 2 pilas, tipo AA. Juego de otoscopio y de otoscopio/oftalmoscopio con conector metálico para el test neumático y con 5 espéculos reutilizables de 2,5 y 4,0 mm en tubo de plástico. Todos los juegos se presentan en estuche de plástico negro moderno.

No. 03171-00 - Otoscopio con mango AA.

No. 03171-01 - Oftalmoscopio con mango AA.

No. 03171-02 - Oto/oftalmoscopio con mangos AA.

Ohrspekula
Ear Specula
Espéculos auriculares



POLITZER
45009-00
Set = 3

- Innen Ø
- = 2,0 mm
45009-02
 - = 3,0 mm
45009-03
 - = 4,0 mm
45009-04



HARTMANN
45010-00
Set = 4,5 - 7,5 mm

- Innen Ø
- = 2,0 mm
45010-20
 - = 3,0 mm
45010-30
 - = 4,5 mm
45010-45
 - = 5,5 mm
45010-55
 - = 6,5 mm
45010-65
 - = 7,5 mm
45010-75



HARTMANN
45011-00
Set 3-7 mm

- schwarz
black
negro
- Innen Ø
- = 2,0 mm
45011-03
 - = 3,5 mm
45011-04
 - = 5,0 mm
45011-05
 - = 6,5 mm
45011-07
 - = 7,5 mm
45011-08



TOYNBEE
45012-00
Set = 5,5 - 7,5 mm

- Innen Ø
- = 4,0 mm
45012-40
 - = 5,5 mm
45012-55
 - = 6,5 mm
45012-65
 - = 7,5 mm
45012-75



GRUBER, rund
45014-00
Set = 4

- Innen Ø
- = 4,5 mm
45014-45
 - = 5,5 mm
45014-55
 - = 6,5 mm
45014-65
 - = 7,5 mm
45014-75



GRUBER, oval
45015-00
Set = 3

- Innen Ø
- = 4,5 mm
45015-45
 - = 5,5 mm
45015-55
 - = 6,5 mm
45015-65

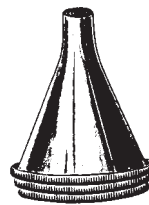

BOUCHERON
45018-00
Set = 4

- Innen Ø
- = 5,0 mm
45018-50
 - = 6,0 mm
45018-60
 - = 7,0 mm
45018-70
 - = 8,0 mm
45018-80

Ohrspekula
Ear Specula
Espéculos auriculares

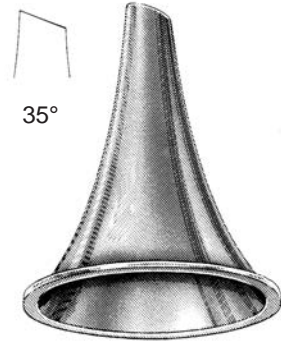
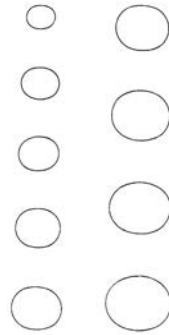
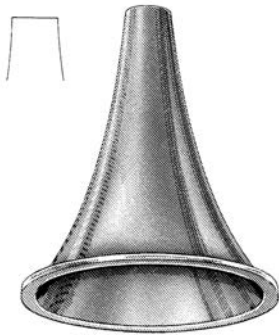

FARRIOR

45019-30	3,0 x 4,0 mm
45019-40	4,0 x 5,0 mm
45019-45	4,5 x 5,5 mm
45019-50	5,0 x 6,0 mm
45019-55	5,5 x 6,5 mm
45019-60	6,0 x 7,0 mm
45019-65	6,5 x 7,5 mm
45019-70	7,0 x 8,0 mm
45019-75	7,5 x 8,5 mm

FARRIOR

45020-30	3,0 x 4,0 mm
45020-40	4,0 x 5,0 mm
45020-45	4,5 x 5,5 mm
45020-50	5,0 x 6,0 mm
45020-55	5,5 x 6,5 mm
45020-60	6,0 x 7,0 mm
45020-65	6,5 x 7,5 mm
45020-70	7,0 x 8,0 mm
45020-75	7,5 x 8,5 mm

Ohrspekula
Ear Specula
Espéculos auriculares

6,5 mm



45030-06

7,5 mm



45030-07

8,2 mm



45030-08

10 mm



45030-10

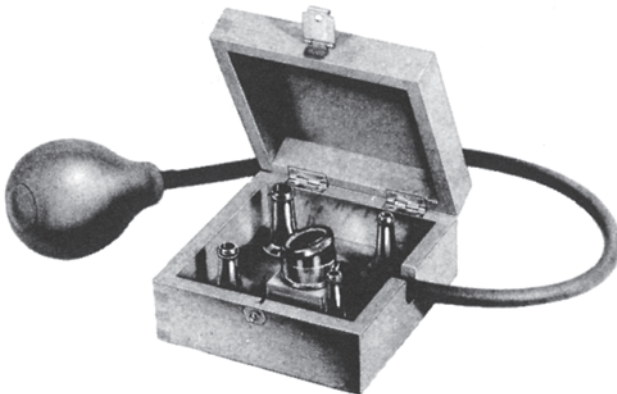

BRUENINGS
45030-04

45030-04

Komplett bestehend aus:
4 Spekula, Saugkammer mit
Gebläse, Holzetui

Complete consisting of:
4 specula, suction head and rubber
tube with bulb, wooden case

Compuesto de:
4 espéculos, cámara de aspiración,
insuflador de goma, en estuche de
madera

Ersatzteile / spare parts / repuestos

45036-09

Lupe / Magnification glass / lupa

45036-10

Saugpumpe / rubber ball / pera de
goma

Ohrspekula
Ear Specula
Espéculos auriculares



7,5 mm Ø



45036-06



8,5 mm Ø



45036-07



9,5 mm Ø



45036-08

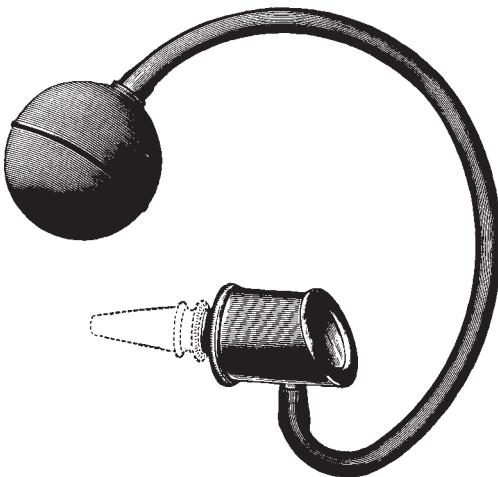

SIEGLE
45036-03

45036-03

Komplett bestehend aus:
Ohrspekulum, 3 Spekula, 1 Gebläse

Complete consisting of:
Ear Specula, 1 rubber tube with bulb

Completo, compuesto de:
Otoscopio con 3 espéculos, insuflador y tubo

Ohrspekulahalter
Ear Specula Holder
Soporte para espejos auriculares

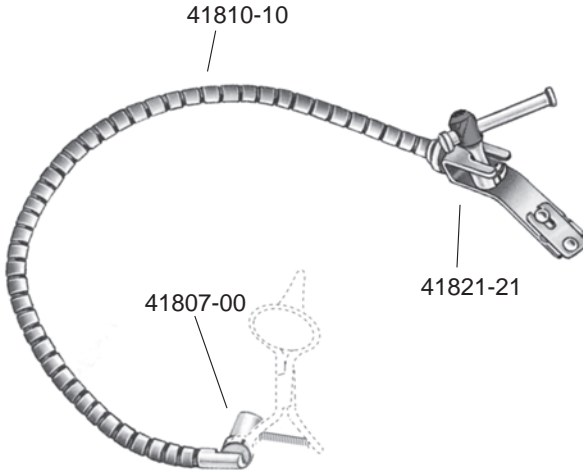

YASARGIL

41803-01 Ohrspekulahalter, komplett, bestehend aus:
ear specula holder, complete, consisting of:
soporte para espejos auriculares completo, compuesto de:

41810-10 flexibler Spannarm
flexible arm, only
brazo flexible, suelto

41821-21 Fixiervorrichtung zum Befestigen an Rohrteilen bis \varnothing 16 mm
clamp for fixation on bars up to \varnothing 16 mm
dispositivo de fijacion para tubos hasta \varnothing 16 mm



41807-00
Ohrspekulahalter alleine
Ear specula holder only
Soporte para espejos auriculares, suelto

Stimmgabeln
Tuning Forks
Diapasones

ALU

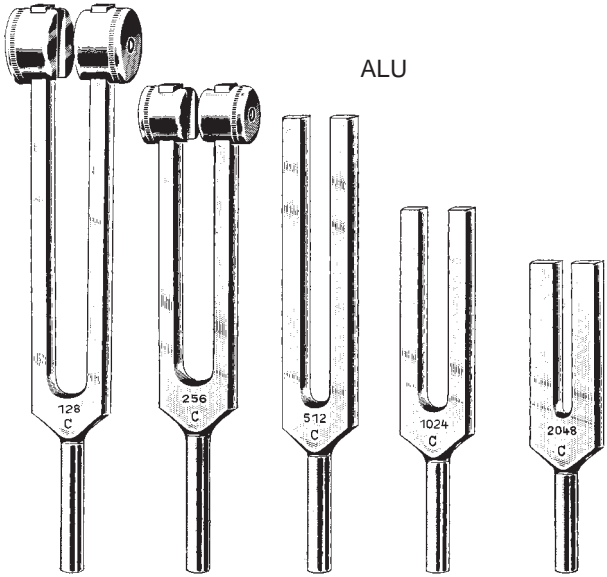

45060-01 C 128
45060-02 C¹ 256
45060-03 C² 512
45060-04 C³ 1024
45060-05 C⁴ 2048

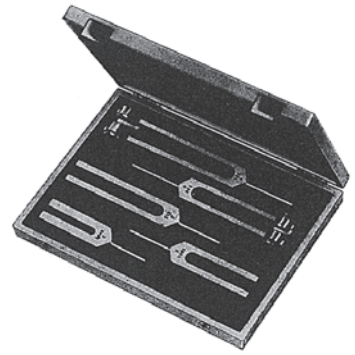

45061-00
compl.

STAINLESS

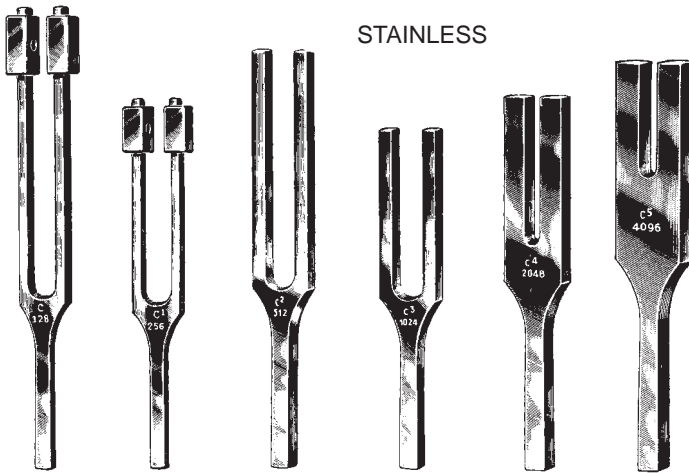

45070-01 C 128
45070-02 C¹ 256
45070-03 C² 512
45070-04 C³ 1024
45070-05 C⁴ 2048
45070-06 C⁵ 4096

HARTMANN

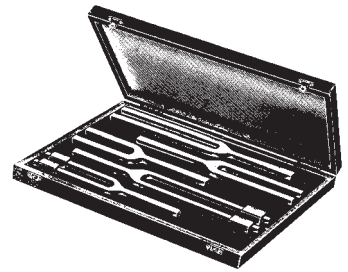

HARTMANN
45071-00
compl.

Stimmgabeln
Tuning Forks
Diapasones



45072-01
a¹ 440



LUCAE

- 45073-01 C 128
- 45073-02 C¹ 256
- 45073-03 C² 512
- 45073-04 C³ 1024
- 45073-05 C⁴ 2048
- 45073-06 C⁵ 4096



LUCAE
45074-01
C 128

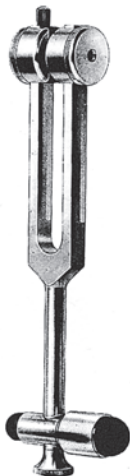

45075-00

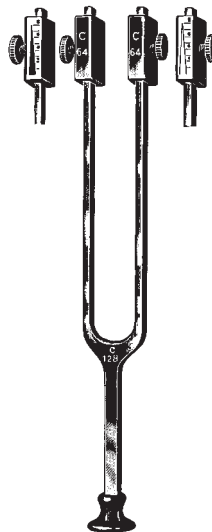

RYDEL-SEIFFERT
45076-01 C 128 / C 64

Lärntrommel, Pulverbläser
 Noise Apparatus, Powder Blowers
 Ensordecedor, Lanzapolvo



BARANY
 45080-00

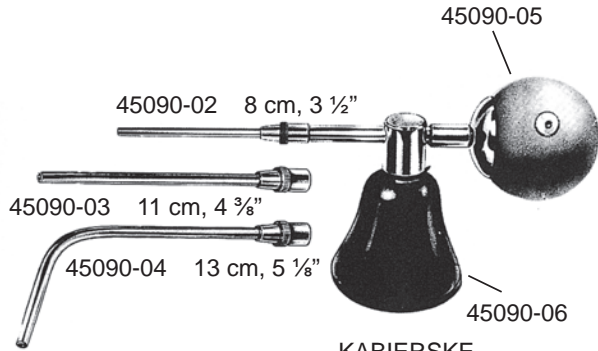

KABIERSKE
 45090-00 30 ccm
 komplett mit 3 Kanülen und Gummiball
 complete with 3 cannulas and rubber bulb
 completo con 3 cánulas y pera de goma

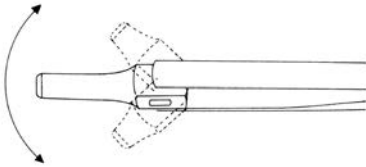

UNIVERSAL
 45090-08

komplett mit beweglicher Düse,
 Schraubflasche 30 ccm und Halbgebläse

complete with movable tube, screw bottle
 30 ccm and rubber bulb

completo con tubo móvil, botella con rosca de
 30 ccm y pera de goma

Luftdusche, Ohrspritze
Air Bag, Ear Syringe
Insuflador de aire, Jeringa auricular

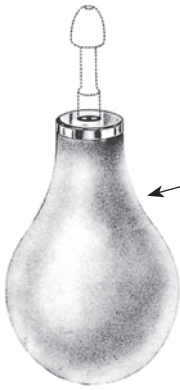

45091-02
Gummibirne alleine
Rubber bulb only
Pera de goma, sola



45091-03



45091-04
4 mm Ø



45091-15
15 mm Ø



45091-17
17 mm Ø



45091-22
22 mm Ø

POLITZER
45091-00 Set
incl.
45091-03
45091-15
45091-17
45091-22

POLITZER
45091-01 Set
incl.
45091-03
45091-04
45091-15
45091-17
45091-22

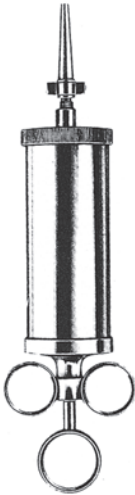

ml REINER, compl.
50 45096-50
75 45096-75
100 45097-10
150 45097-15

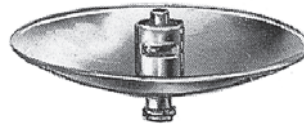

45097-01



45097-02



45097-03

Ohrspritze
Ear Syringe
Jeringa auricular

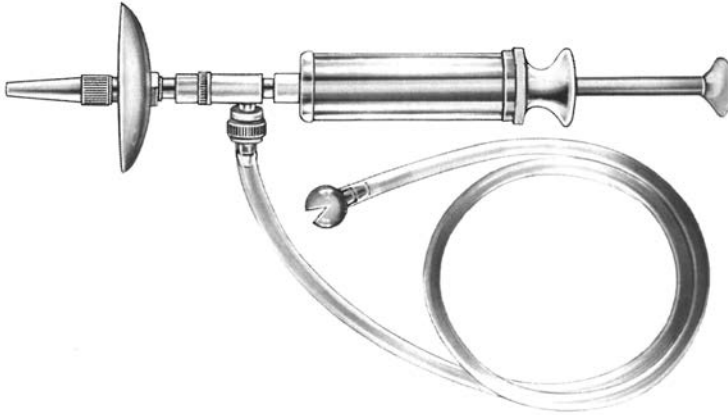

45096-00

Ohrspritze komplett, 10 ml selbstfüllend mit Luer-Lock Ansatz
Ear syringe, 10 ml one hand filling and emptying, Luer-Lock attachment
Jeringa auricular, 10 ml, con conexión Luer-Lock

Ohrsonden, Watteträger
 Ear Probe, Cotton Applicators
 Sondas auriculares, Porta-algodones

ø 1 mm
 Silber



STACKE
 21115-10
 10,5 cm 4.1"

ø 1,2 mm

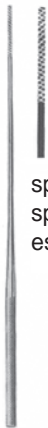

spiralförmig
 spiral threads
 estrías espirales

FARRELL

4 ¾"	21270-12	12,0 cm
5 ½"	21270-14	14,0 cm
6 ½"	21270-16	16,5 cm

ø 1,2 mm



FARRELL

21272-12	12,0 cm
21272-14	14,0 cm
21272-16	16,5 cm

ø 1 mm

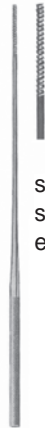

spiralförmig
 spiral threads
 estrías espirales

FROHN

4 ¾"	21277-12	12,0 cm
5 ½"	21277-14	14,0 cm
6 ¼"	21277-16	16,0 cm

Watteträger
Cotton Applicators
Porta-algodones



spiralförmig
spiral threads
estrias espirales

REDA

21290-12 12,0 cm, 4 ¾"
21290-14 14,0 cm, 5 ½"
21290-16 16,0 cm, 6 ¼"



REDA

21292-12 12,0 cm, 4 ¾"
21292-14 14,0 cm, 5 ½"
21292-16 16,0 cm, 6 ¼"

ø 1,3 mm



UCKERMANN
21310-15 15 cm, 6"

ø 3 mm



JOBSON-HORNE
21320-12 12 cm, 4 ¾"
21320-18 18 cm, 7"

Löffel, Schlingen, Hebel
Ear Spoons, Loops, Elevator
Cucharas, Asas, Elevador



GROSS
45171-12
12 cm, 4 $\frac{3}{4}$ "



GROSS
45173-12
12 cm, 4 $\frac{3}{4}$ "



BILLEAU
16 cm, 6 $\frac{1}{4}$ "



LANGENBECK
45181-13
13 cm, 5 $\frac{1}{8}$ "



ZAUFAL
45184-16
16 cm, 6 $\frac{1}{4}$ "



ZAUFAL-JANSEN
45185-15
15 cm, 6"

Häkchen
Ear Hooks
Ganchitos

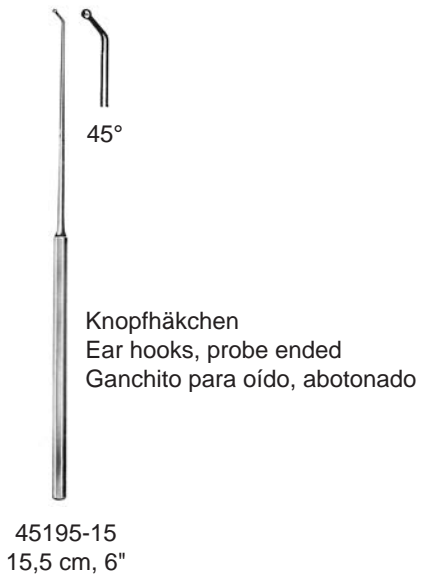
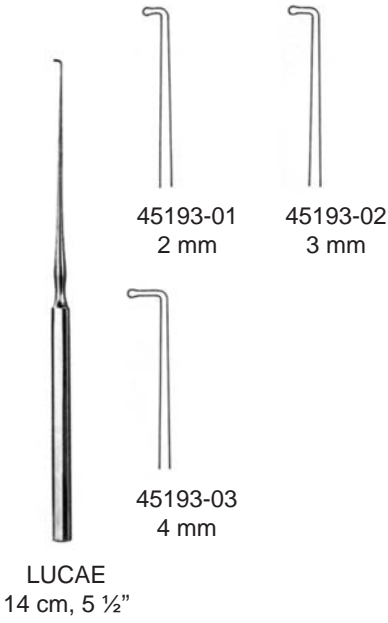
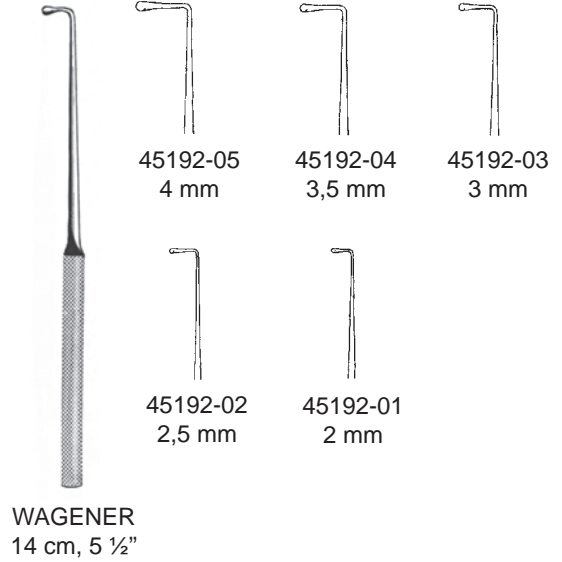
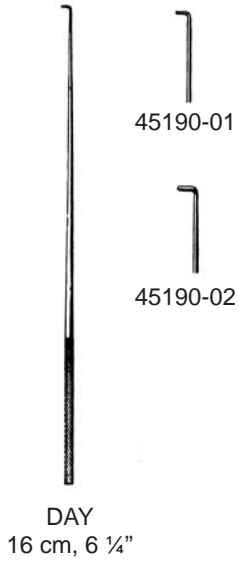

Ohrschlingen
Ear Loops
Lazos auriculares



45194-01



45194-02



45194-03



45194-04



SHAPLEIGH
13 cm, 5 1/8"



45195-00



45195-01











45195-02



WEBER-LOCH
16 cm, 6 1/4"







Ohrküretten
 Ear Currettes
 Curetas auriculares

	Innen Ø Inner Ø interior Ø	1.5 mm	1.9 mm	2.5 mm	2.7 mm
Küretten Currettes Curetas					
		Fig. 00	0	1	2
stumpf blunt romas		45109-00	45110-00	45110-01	45110-02
scharf sharp cortantes		45111-00	45112-00	45112-01	45112-02
stumpf blunt romas		45114-00	45115-00	45115-01	45115-02
scharf sharp cortantes		45116-00	45117-00	45117-01	45117-02



BUCK
 14,5 cm, 5 3/4"

Ohrküretten
Ear Currettes
Curetas auriculares

	Innen Ø Inner Ø interior Ø	3.4 mm	4.0 mm	4.5 mm
Küretten Currettes Curetas				
		3	4	5
stumpf blunt romas		45110-03	45110-04	45110-05
scharf sharp cortantes		45112-03	45112-04	45112-05
stumpf blunt romas		45115-03	45115-04	45115-05
scharf sharp cortantes		45117-03	45117-04	45117-05

BUCK
14,5 cm, 5 3/4"

Ohrkatheter, Trommelfellnadel
 Catheters, Tympanum Knives
 Cateteres, agujas para timpano

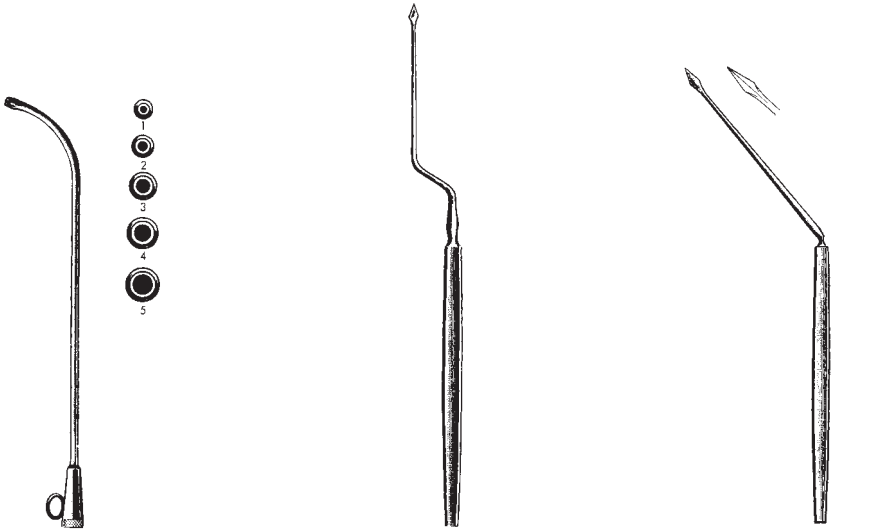

Fig. HARTMANN
 1 45133-01 2,5 mm
 2 45133-02 3,0 mm
 3 45133-03 3,5 mm
 4 45133-04 4,0 mm
 5 45133-05 5,0 mm

POLITZER
 45150-18
 18 cm, 7"

POLITZER
 45151-16
 16,5 cm, 6 ½"



für Kinder
 for children
 para niños

LUCAE
 45152-01
 18 cm, 7"



für Erwachsene
 for adults
 para adultos

LUCAE
 45152-02
 18 cm, 7"

Trommelfellnadel
Tympanum Knives
Cuchillos para timpano

mit Schraubgriff
with screw-locking handle
con mango roscado

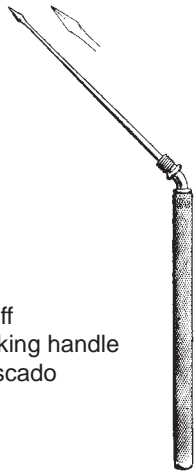

POLITZER
45153-16
16 cm, 6 1/4"



POLITZER
45160-15
15 cm, 6"



SEXTON
45162-18
18 cm, 7"



SEXTON
45164-17
17 cm, 6 3/4"



SEXTON
45165-17
17 cm, 6 3/4"

Ohrpolypenschnürer
Ear Polypus Snares
Polipotomos auriculares



KRAUSE
45220-16
16 cm, 6 1/4"

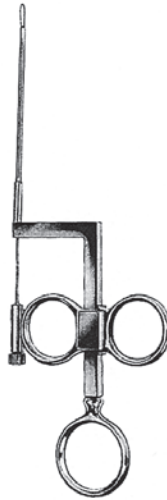

WILDE
45222-17
17 cm, 6 3/4"



45225-02
doz./doc./dozz.
0,2 mm

Fremdkörperheber
Foreign Body Levers
Elevadores para cuerpos extraños



QUIRE
45251-10
10 cm, 4"

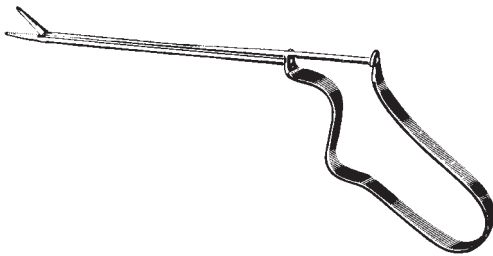

BUCK
45253-11
11 cm, 4 ³/₈"

Ohrzängchen
Ear Forceps
Pinzas auriculares

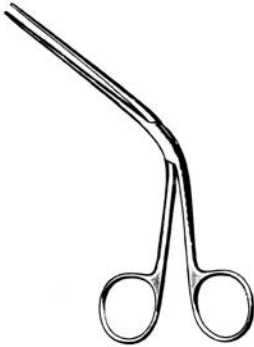

TILLEY
45243-14
14 cm, 5 1/2"



LITTAUER
45245-12
12 cm, 4 3/4"

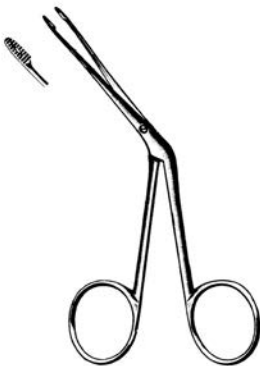

HARTMANN
45246-12
12 cm, 4 3/4"



HARTMANN
45246-14
14 cm, 5 1/2"

Mikro Ohrzängchen
 Micro Ear Forceps
 Micro pinzas auriculares

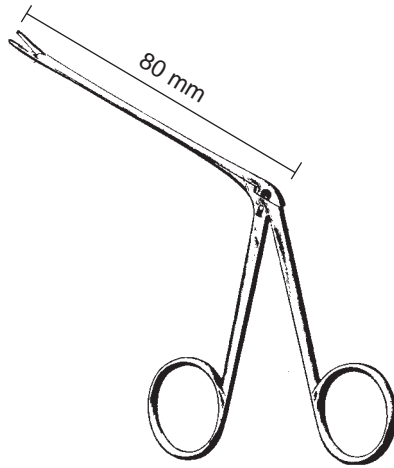

HARTMANN-WULLSTEIN
 45255-08
 8,5 cm, 3.4"

o 1 mm Ø



HARTMANN-WULLSTEIN
 45257-08
 8,5 cm, 3.4"



HARTMANN
 45261-08 8,5 cm, 3.4"
 45261-14 14,0 cm, 5 1/2"
 45261-16 16,0 cm, 6 1/4"



HARTMANN
 45263-08 8,5 cm, 3.4"
 45263-14 14,0 cm, 5 1/2"



HARTMANN
 45265-08
 8,5 cm, 3.4"



Ø mm **HARTMANN**
 2,0 45267-20 8,5 cm, 3.4"
 2,5 45267-25 8,5 cm, 3.4"
 3,0 45267-30 8,5 cm, 3.4"

3 mm Ø

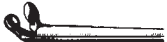

HARTMANN
 45269-30
 8,5 cm, 3.4"



STRUEMPEL
 45271-08 8,5 cm, 3.4"
 2,5x5 mm



HARTMANN
 45273-08
 8,5 cm, 3.4"

o 2 mm Ø



HARTMANN-WEINGÄRTNER
 45274-08
 8,5 cm, 3.4"



HARTMANN-HOFFMANN
 45275-08
 8,5 cm, 3.4"



45276-08 Entenschnabel
 14 cm, 5 1/2" Duckbill
 Pico de pato

Mikro Ohrzängchen
 Micro Ear Forceps
 Micro pinzas auriculares

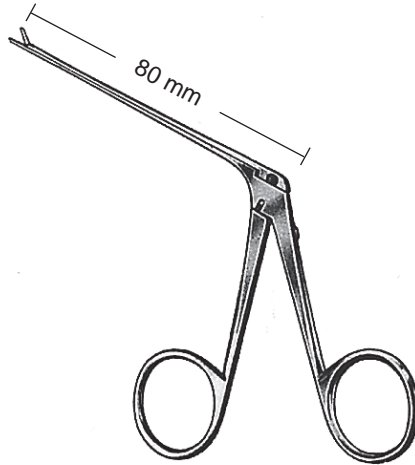

A
 45350-40
 0,9 x 4 mm



A
 45350-70
 0,9 x 7 mm

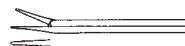

A
 45352-40
 0,9 x 4 mm

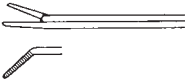

C
 45353-60
 0,9 x 6 mm

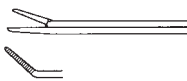

B
 45355-60
 0,9 x 6 mm



D
 45357-40
 0,9 x 4 mm



E
 45359-40
 0,9 x 4 mm



A
 45360-35
 0,6 x 3 mm

extra zart
 very delicate
 muy fina

- A:** gerade / straight / recta
- B:** rechts / right / derecha
- C:** links / left / izquierda
- D:** aufgebogen / curved up / curva hacia arriba
- E:** nach unten gebogen / curved down / curva hacia abajo

Mikro Ohrzängchen
Micro Ear Forceps
Micro pinzas auriculares

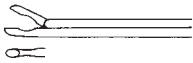
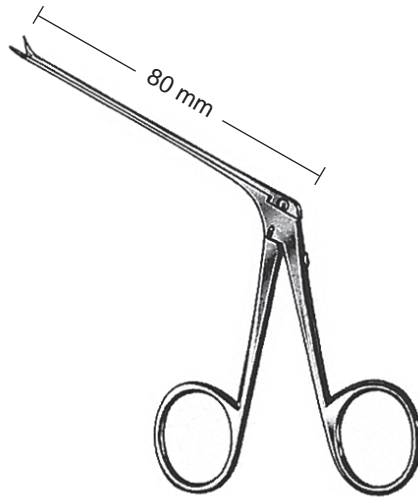

A

45361-01
0,6 x 4,5 mm

45362-45
0,9 x 4,5 mm



C

45361-02
0,6 x 4,5 mm

45363-45
0,9 x 4,5 mm



B

45361-03
0,6 x 4,5 mm

45365-45
0,9 x 4,5 mm

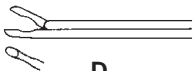

D

45361-04
0,6 x 5,0 mm

45367-50
0,9 x 5,0 mm

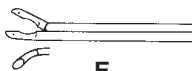

E

45361-05
0,6 x 5,0 mm

45369-50
0,9 x 5,0 mm

A: gerade / straight / recta

B: rechts / right / derecha

C: links / left / izquierda

D: aufgebogen / curved up / curva hacia arriba

E: nach unten gebogen / curved down / curva hacia abajo

Mikro Ohrzängchen
Micro Ear Forceps
Micro pinzas auriculares



A
45390-35
0,8 x 3,5 mm



A
45390-50
1 x 5 mm



F
45391-35
0,8 x 3,5 mm



E
45392-35
0,8 x 3,5 mm



C
45393-50
1 x 5 mm



B
45394-50
1 x 5 mm

A: gerade / straight / recta

B: rechts / right / derecha

C: links / left / izquierda

E: nach unten gebogen / curved down / curva hacia abajo

F: nach oben gebogen / curved upwards / curva hacia arriba

Mikro Ohrzängchen
Micro Ear Forceps
Micro pinzas auriculares

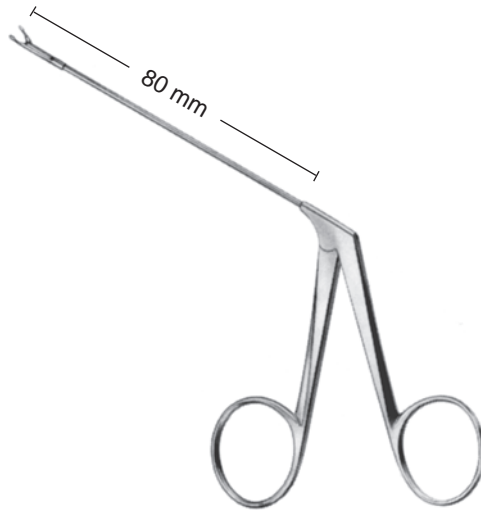

WULLSTEIN



A
45400-01
0,9 x 1 mm



A
45400-02
0,8 x 1,3 mm



A
45400-03
1 mm



A
45401-25
1,7 x 2,5 mm



D
45402-10
0,9 x 1 mm



C
45403-13
0,8 x 1,3 mm



B
45404-13
0,8 x 1,3 mm

A: gerade / straight / recta
B: rechts / right / derecha
C: links / left / izquierda
D: aufgebogen / curved up / curva hacia arriba

Mikro Ohrscheren
 Micro Ear Scissors
 Micro tijeras auriculares

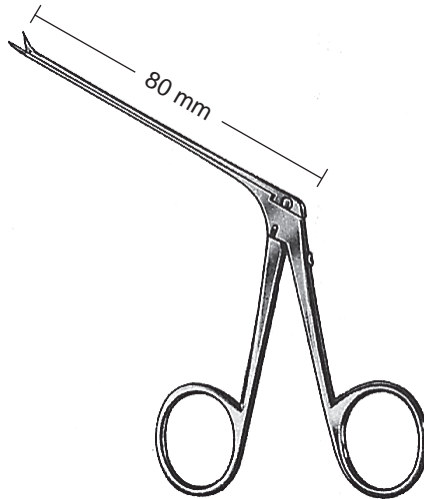

A
 BELLUCCI
 45300-30
 3 mm
 extra zart
 very delicate
 muy fina



A
 BELLUCCI
 45310-40
 4 mm
 micro mini



A
 BELLUCCI
 45312-55
 5,5 mm
 micro standard

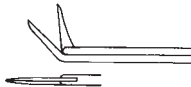

D
 BELLUCCI
 45313-55
 5,5 mm
 micro standard



B
 BELLUCCI
 45315-55
 5,5 mm
 micro standard



C
 BELLUCCI
 45317-55
 5,5 mm
 micro standard



A
 SHEA
 45320-70
 7,0 mm



C
 SHEA
 45321-70
 7,0 mm

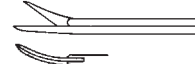

B
 SHEA
 45322-70
 7,0 mm

- A:** gerade / straight / recta
- B:** rechts / right / derecha
- C:** links / left / izquierda
- D:** aufgebogen / curved up / curva hacia arriba
- E:** nach unten gebogen / curved down / curva hacia abajo

Drahtbiegezängchen, Faßzängchen
Wire Bending Forceps, Grasping Forceps
Pinzas plegadoreas del alambre, Pinza prensora

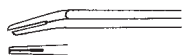

McGEE
45371-40
0,8 x 4,0 mm

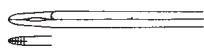

GREVEN
45370-50
0,8 x 5,0 mm



SCHUKNECHT
45372-60
0,8 x 6,0 mm

Mikro Ohrscheren
Micro Ear Scissors
Micro tijeras auriculares



FISCH



B
FISCH
45324-03
3,0 mm



C
FISCH
45325-03
3,0 mm

B: rechts / right / derecha
C: links / left / izquierda

Mikro Ohrscheren
Micro Ear Scissors
Micro tijeras auriculares

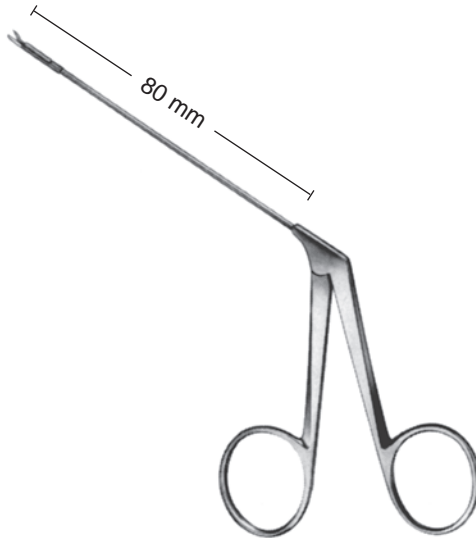

WULLSTEIN



A
45410-01



F
45411-01



C
45412-01



B
45413-01



G
45414-01

A: gerade / straight / recta

B: rechts / right / derecha

C: links / left / izquierda

F: nach oben gebogen / curved upwards / curva hacia arriba

G: horizontal schneidend / horizontal cutting / corte horizontal

Hammerkopfstanze
Malleus Punch
Pinza para cabeza del martillo

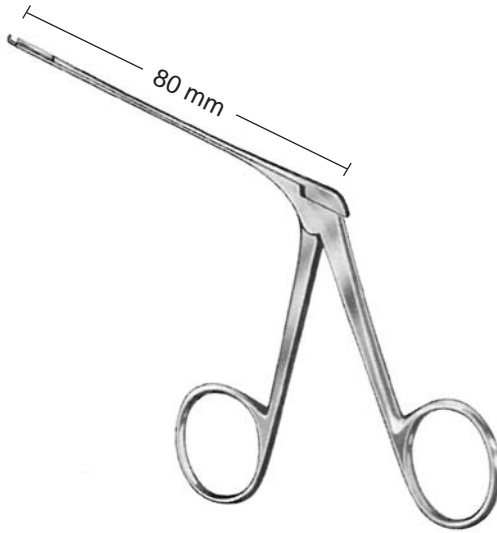

DIETER

micro ø 1,3 mm



45385-01

aufwärts
upward
arriba

mini ø 1,8 mm

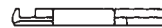

45387-01

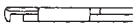

45385-02

abwärts
downward
abajo



45387-02

Biegegerät, Quetschzange
Bending Device, Pressure Forceps
Dispositivo para modelar, Pinza para aplastar



SCHUKNECHT
45430-00

16 x 12 mm



HOUSE-GELFOAM
45440-19
19 cm, 7 1/2"

Elevatoren, Raspatorien
Elevators, Raspatories
Elevadores, Periostótomos



SEBILEAU
33707-17
17,5 cm, 7"



QUERVAIN
33708-19
19,5 cm, 7 3/4"

16 mm



LANGENBECK
33710-19
19 cm, 7 1/2"

5 mm

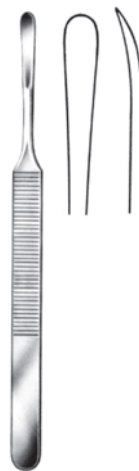

KÖNIG
33714-15
15,5 cm, 6"

Raspatorien
Raspatories
Periostótomos

4 mm



WILLIGER
33711-16
16 cm, 6 ¼"

6,5 mm



WILLIGER
33712-16
16 cm, 6 ¼"

5 mm



WILLIGER
33713-16
16 cm, 6 ¼"

5,5 mm



WILLIGER
33713-17
17 cm, 6 ¾"

Raspatorien, Elevatoren
Raspatories, Elevators
Periostótomos, Elevadores



JOSEPH
33718-16
16 cm, 6 ¼"



LEMPERT
16 cm, 6 ¼"



LEMPERT
45806-16
16 cm, 6 ¼"

Raspatorien
Raspatories
Periostótomos

mit Ferrozellgriff
with Ferrozell-Handle
con mango de Ferrozell

6 mm



33740-19
19 cm, 7 1/2"

3 mm



33741-18
18,5 cm, 7 1/4"

6 mm



33742-18
18,5 cm, 7 1/4"

6 mm



33743-18
18,5 cm, 7 1/4"

Raspatorien
Raspatories
Periostótomos

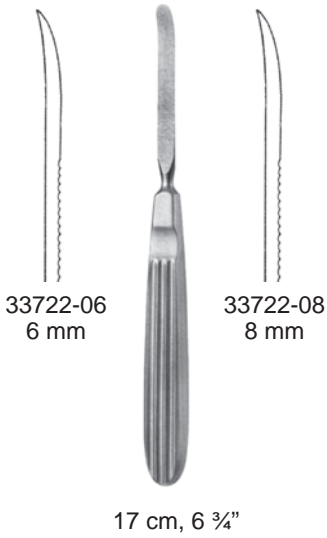

6 mm



LEMPERT
45807-20
20,5 cm, 8"

15 mm

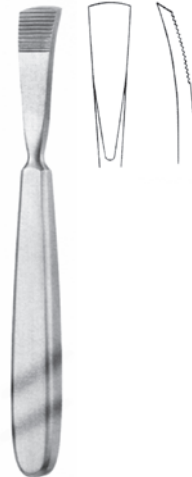

JANSEN
33701-16
16,5 cm, 6 1/2"

4,5 mm



FREER
47415-18
18 cm, 7"

Elevatoren, Raspatorien
 Elevators, Raspatories
 Elevadores, Periostótomos



47410-04
4 mm



47410-05
5 mm



McKENTY
15 cm, 6"

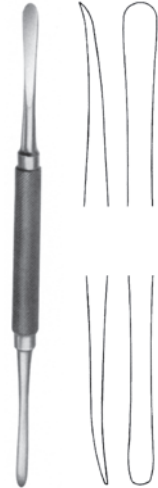

MOLT
33716-18
18 cm, 7"



MILLER
17 cm, 6 3/4"



33724-02
2 mm

33724-03
3 mm

33724-04
4 mm



WULLSTEIN
45806-17
17 cm, 6 3/4"

Dissektor, Raspatorien
Excavator, Raspatories
Disector, Periostótomos

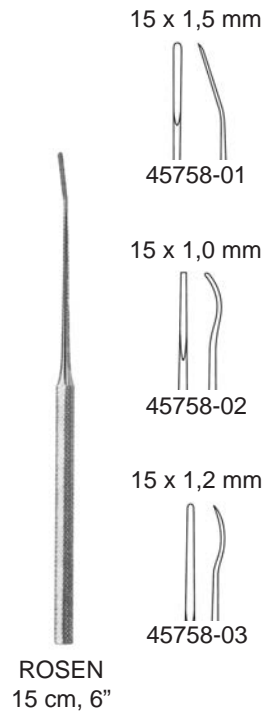
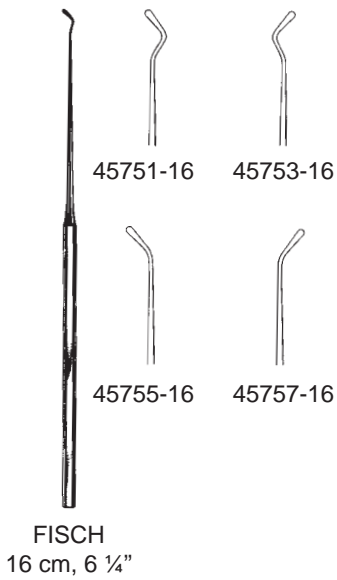

Ohrpinzetten
Ear Forceps
Pinzas auriculares

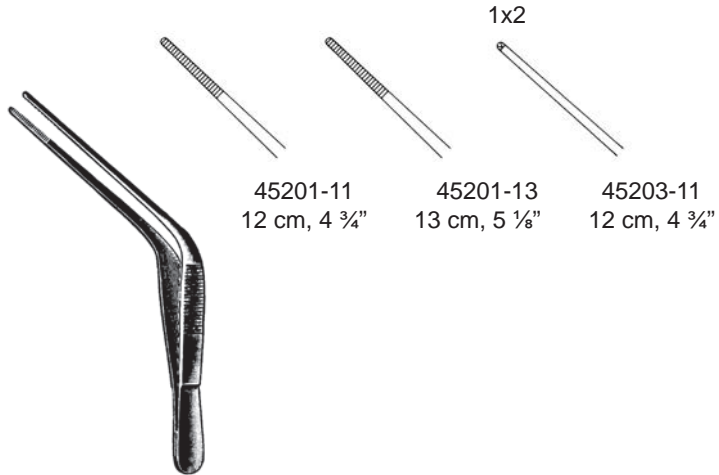

45201-11
12 cm, 4 ¾"

45201-13
13 cm, 5 ⅙"

45203-11
12 cm, 4 ¾"

WILDE (TROELTSCH)

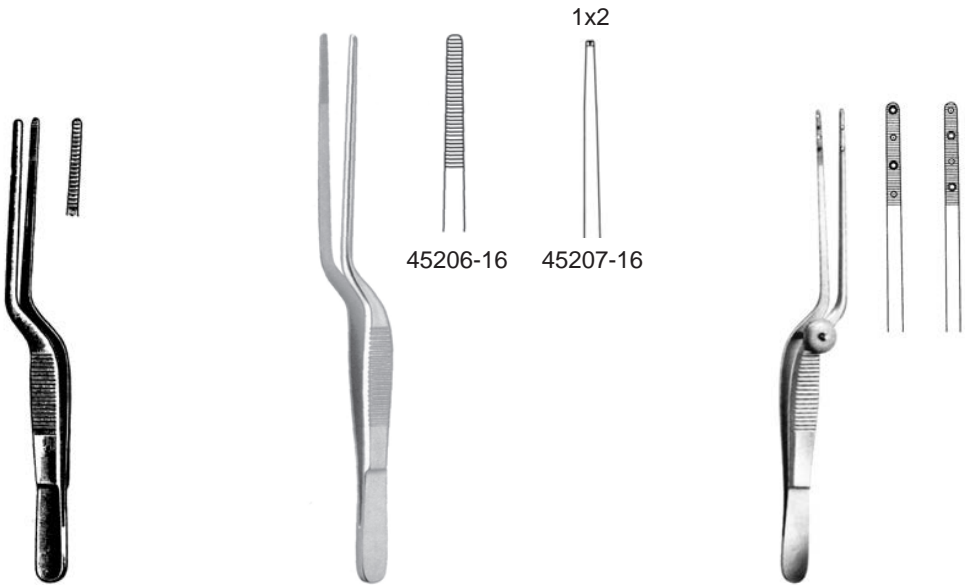

LUCAE
45206-14
14 cm, 5 ½"

LUCAE
16 cm, 6 ¼"

COTTLE
45208-14
14 cm, 5 ½"

Anatomische und chirurgische Pinzetten
Dressing and Tissue Forceps
Pinzas de disección, sin/con dientes



STANDARD
11120-11
11,5 cm 4 ½"



GRAEFE
11190-10
10,5 cm, 4.1"



SEMKEN
11260-12 12,5 cm, 5"
11260-15 15,5 cm, 6"



SEMKEN
11270-12 12,5 cm, 5"
11270-15 15,5 cm, 6"

Uhrmacherpinzetten
Jeweler Type Forceps
Pinzas de relojero

Fig. 1



11401-01
12 cm, 4 3/4"

Fig. 3



11403-03
12 cm, 4 3/4"

Fig. 3c



11403-04
11 cm, 4 3/8"

Fig. 4



11404-04
11 cm, 4 3/8"

Fig. 5



11405-05
11 cm, 4 3/8"

Fig. 7



11407-07
12 cm, 4 3/4"

Ohrpinzetten
Ear Forceps
Pinzas auriculares



ADSON

11170-12 12,0 cm, 4 $\frac{3}{4}$ "
11170-15 15,0 cm, 6"



1x2

ADSON

11180-12 12,0 cm, 4 $\frac{3}{4}$ "
11180-15 15,0 cm, 6"

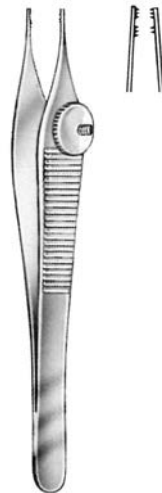

DERLACKI

45209-12
12 cm, 4 $\frac{3}{4}$ "

Flachmeißel, Hohlmeißel, Stößel
 Chisels, Gouges, Tamper
 Cinceles, Gubias, Hemostático



33600-02
2 mm

33600-03
3 mm

33600-04
4 mm

33600-05
5 mm

16 cm, 6 1/4"

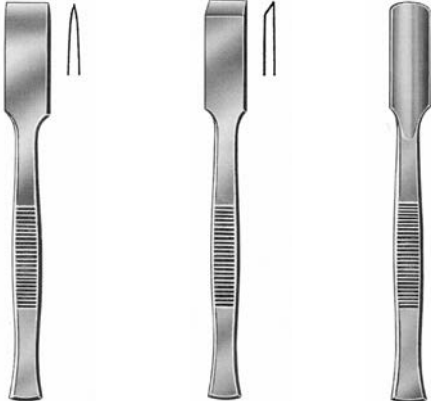

13,5 cm, 5 1/4" 13,5 cm, 5 1/4" 13,5 cm, 5 1/4"

4 mm	33602-04	33604-04	33605-04
6 mm	33602-06	33604-06	33605-06
8 mm	33602-08	33604-08	33605-08
10 mm	33602-10	33604-10	33605-10
12 mm	33602-12	33604-12	33605-12
14 mm	33602-14	33604-14	33605-14
16 mm	33602-16	33604-16	33605-16



33626-25
2,5 mm



33626-35
3,5 mm

PASSOW
12 cm, 4 3/4"



33628-03
3 mm



33628-05
5 mm

BRÜNING-S-LUCAS
16 cm, 6 1/4"

Flachmeißel, Hohlmeißel, Osteotome
 Chisels, Gouges, Osteotome
 Cinceles, Gubias, Osteótomo



PARTSCH
 13,5 cm, 5 ¼"
 33620-02 2 mm
 33620-03 3 mm
 33620-04 4 mm
 33620-05 5 mm
 33620-06 6 mm



PARTSCH
 13,5 cm, 5 ¼"
 33623-02 2 mm
 33623-03 3 mm
 33623-04 4 mm
 33623-05 5 mm
 33623-06 6 mm

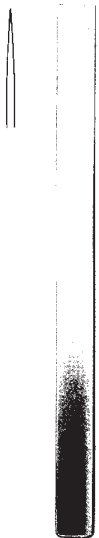

2 mm 3 mm 4 mm

6 mm 8 mm 10 mm

12 mm 15 mm

12,5 cm, 5"	mm	17 cm, 6 ¾"
33654-02	2	33652-02
33654-03	3	33652-03
33654-04	4	33652-04
33654-06	6	33652-06
33654-08	8	33652-08
33654-10	10	33652-10
33654-12	12	33652-12
33654-15	15	33652-15

MINI-LAMBOTTE

Flachmeißel und Hohlmeißel mit Ferrozellgriff, Osteotome
 Chisels and Gouges with Ferrozell-Handle, Osteotome
 Cinceles, Gubias con mango de Ferrozell, Osteótomo

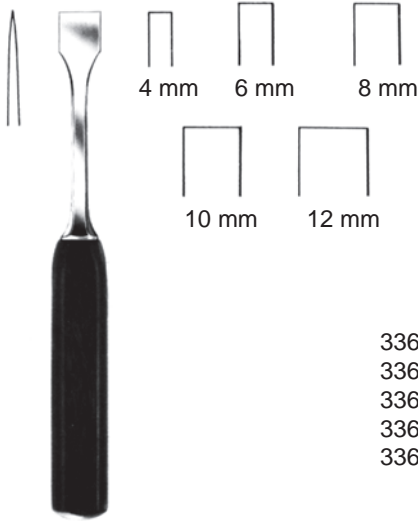

LEXER MINI
18 cm, 7"

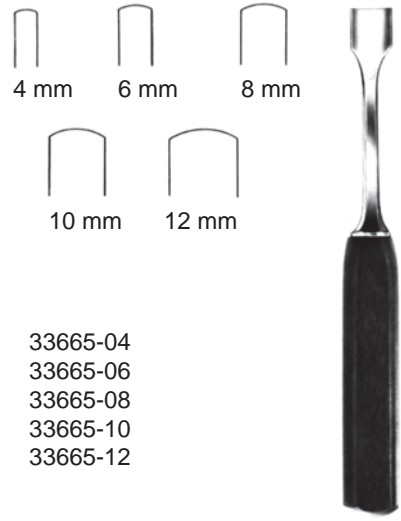

LEXER MINI
18 cm, 7"

33664-04	4 mm	33665-04
33664-06	6 mm	33665-06
33664-08	8 mm	33665-08
33664-10	10 mm	33665-10
33664-12	12 mm	33665-12



FREER
47450-04
15 cm, 6"



FREER
47451-04
15 cm, 6"

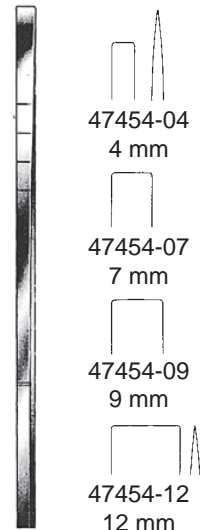

COTTLE
18 cm, 7"

Septum Osteotom
Rhinoplastic Osteotome
Osteotomo para rinoplastia

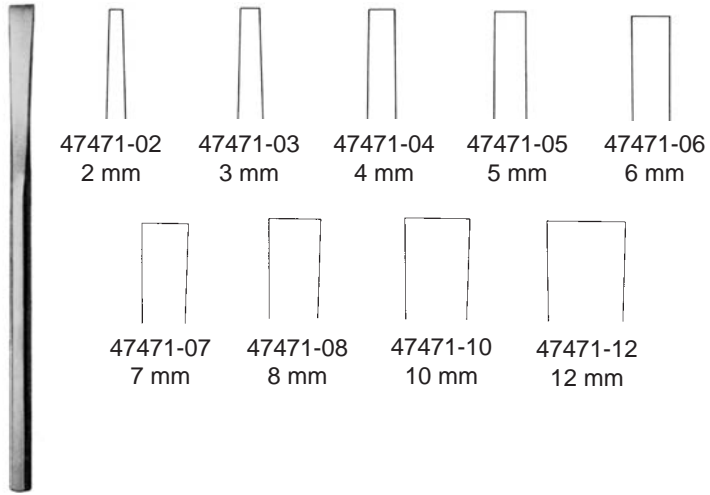

SHEEHAN
16 cm, 6 ¼"

Hämmer
Mallets
Martillos

massiv, mit auswechselbaren Ferrozellbacken
solid, with interchangeable Ferrozell jaws
macizo, con tapas intercambiables de Ferrozell

Ø 20 mm



MEAD
17 cm, 6 3/4"
33693-32 320 g

Ø 25 mm



135 g

33694-01 18,5 cm, 7 1/4"
33694-03 Ersatzbacken
Nylon Caps
Tapas de repuesto

Ø 22 mm

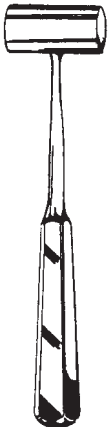

PARTSCH
33698-98
18 cm, 7"
199 g

Ø 30 mm



COTTLE
18 cm, 7" 240 g
33700-05

Ø 27 mm



HAJEK
21 cm, 8 1/4" 140 g
33700-08

Scharfe Löffel
Bone Curettes
Cucharillas cortantes

Fig.	SPRATT
0000	33474-96
000	33474-97
00	33474-98
0	33475-00
1	33475-01
2	33475-02
3	33475-03
4	33475-04
5	33475-05
6	33475-06

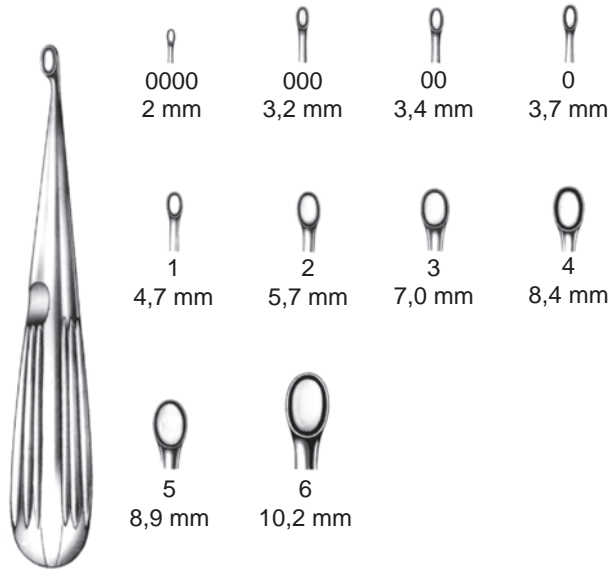

SPRATT
17 cm, 6 3/4"

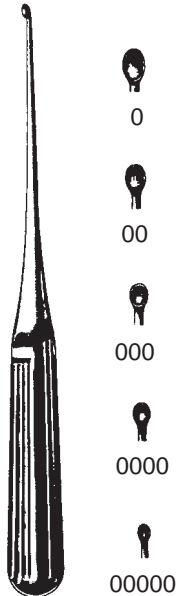

LEMPERT
17,5 cm, 7"

Fig.	0	33490-10	3,3 mm
	00	33490-20	3,0 mm
	000	33490-30	2,7 mm
	0000	33490-40	2,4 mm
	00000	33490-50	2,0 mm



JANSEN
33495-16 16 cm, 6 1/4"

Scharfe Löffel
Bone Curettes
Cucharillas cortantes



BARTH
33393-18, 18 cm, 7"



HALLE
21 cm, 8 1/4"

Fig.
1 33476-01 4,8 mm
2 33476-02 5,8 mm
3 33476-03 6,8 mm

biegsam
malleable
maleable

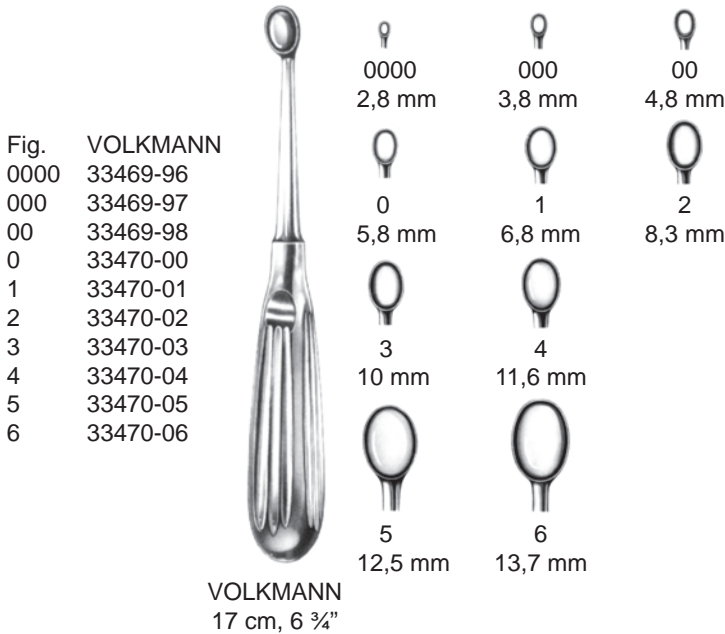

VOLKMANN
17 cm, 6 3/4"

Scharfe Löffel
Bone Currettes
Cucharillas cortantes

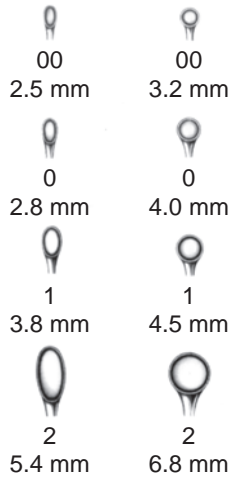

WILLIGER 17,5 cm, 7"	Fig. 00	33485-99	33486-99
	0	33486-00	33487-00
	1	33486-01	33487-01
	2	33486-02	33487-02

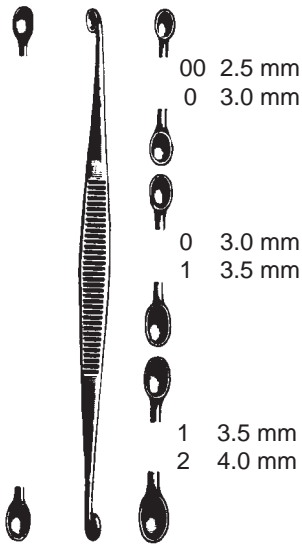

WILLIGER 13,5 cm, 5 1/4"	Fig. 00/0	33496-00
	0/1	33496-01
	1/2	33496-12

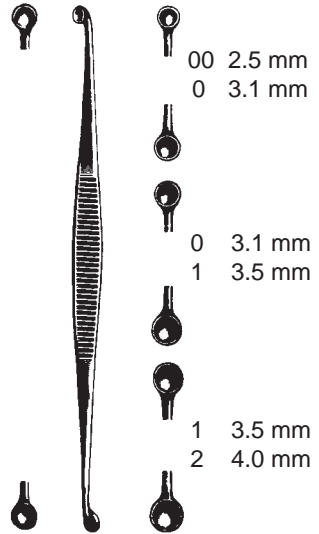

MARTINI 13,5 cm, 5 1/4"	Fig. 00/0	33498-00
	0/1	33498-01
	1/2	33498-12

Hohlmeißelzangen
Bone Rongeurs
Pinzas-gubias

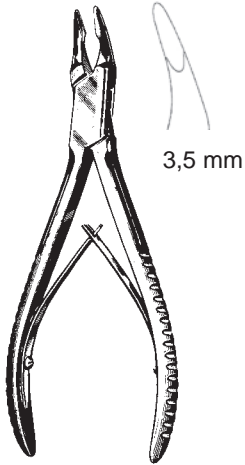

BLUMENTHAL
33115-15
15,5 cm, 6"

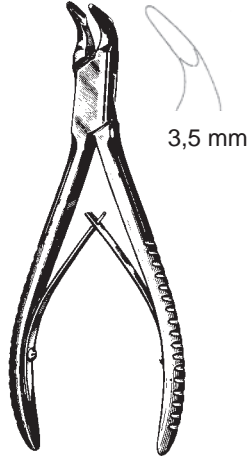

BLUMENTHAL
33117-15
15,5 cm, 6"

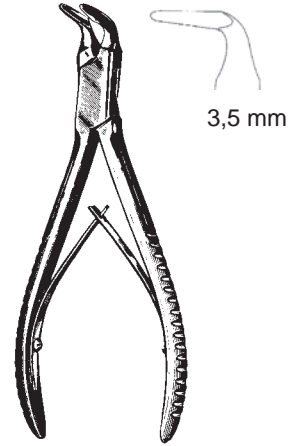

BLUMENTHAL
33119-15
15,5 cm, 6"



LUER
33131-15
15 cm, 5.9"

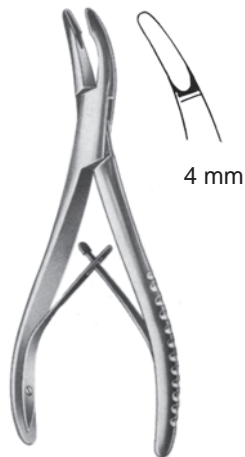

LUER
33133-15
15 cm, 5.9"

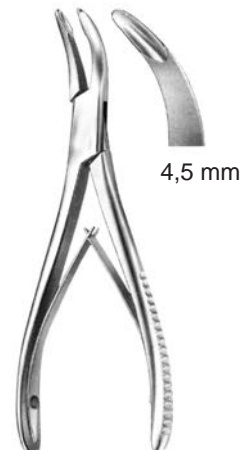

BANE-HARTMANN
33148-18
17,5 cm, 7"

Hohlmeißelzangen
 Bone Rongeurs
 Pinzas-gubias



— LEMPERT —
 33150-16 33151-16
 16 cm, 6 ¼"



BEYER
 33156-18
 18 cm, 7"

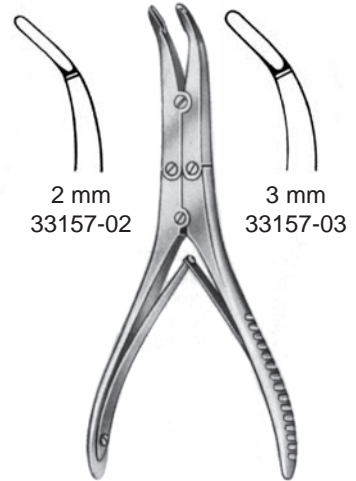

KLEINERT-KUTZ
 15 cm, 6"



BEYER
 33201-18
 18 cm, 7"



ZAUFAL-JANSEN
 33205-18
 18 cm, 7"



— BÖHLER —
 33211-15 33213-15
 15 cm, 6"

Knochensplitterzangen
Bone Cutting Forceps
Pinzas cortantes para huesos



— BÖHLER —
33280-15 33281-15
15 cm, 6"



COTTLE-KAZANJIAN
33282-19
19 cm, 7 ½"



MC INDOE
33283-17
17 cm, 6 ¾"

Knochenstanzen
Bone Punches
Pinzas sacabocado



KERRISON

3x3 mm 47303-03
4x4 mm 47303-04
5x5 mm 47303-05
6x6 mm 47303-06
17 cm, 6 $\frac{3}{4}$ "



CITELLI

47311-10 1,0 mm
47311-25 2,5 mm
47311-30 3,0 mm

Wundsperrer
Retractors
Separadores

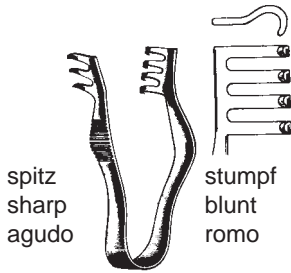

spitz
sharp
agudo

stumpf
blunt
romo

FINSEN

19610-07 7 cm, 2 3/4" 19611-07

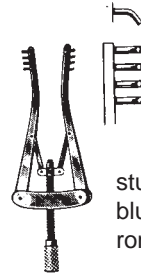

spitz
sharp
agudo

stumpf
blunt
romo

ALM

19620-07 7 cm, 2 3/4" 19621-07
19620-10 10 cm, 4" 19621-10

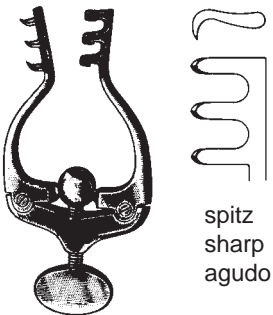

spitz
sharp
agudo

JANSEN
19630-10
10 cm, 4"

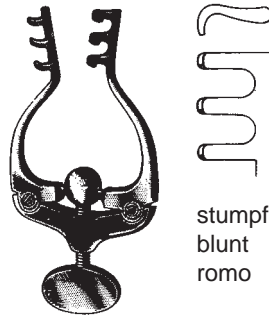

stumpf
blunt
romo

JANSEN
19631-10
10 cm, 4"



spitz
sharp
agudo

stumpf
blunt
romo

HOLZHEIMER
19634-10 19635-10
10 cm, 4"

Wundsperrer
Retractors
Separadores

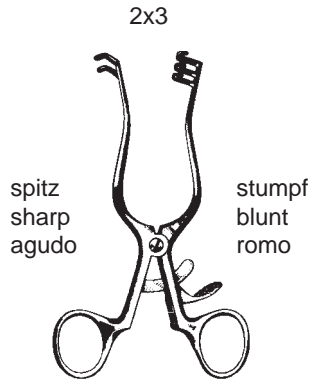

WEITLANER
19650-10 19651-10
11,5 cm, 4 1/2"

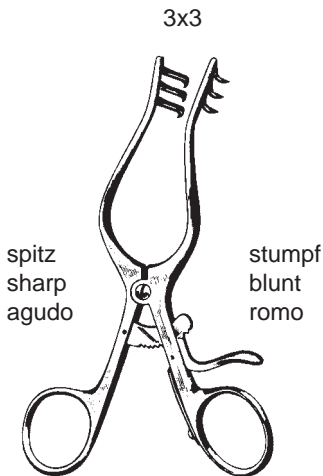

WEITLANER-WULLSTEIN
19654-13 19655-13
13 cm, 5 1/8"

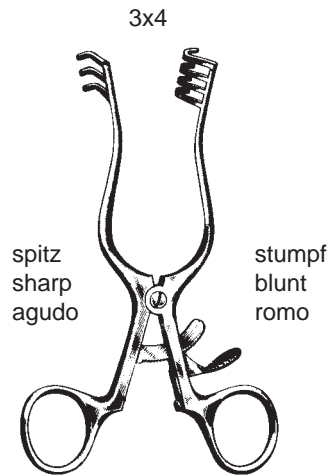

WEITLANER
19670-14 14,0 cm, 5 1/2" 19671-14
19670-16 16,5 cm, 6 1/2" 19671-16

Wundsperrer
Retractors
Separadores

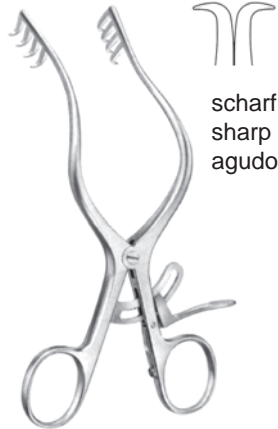

scharf
sharp
agudo

MOLLISON
19674-15
15 cm, 6"



stumpf
blunt
romo

FISCH
19683-17
17 cm, 6 3/4"

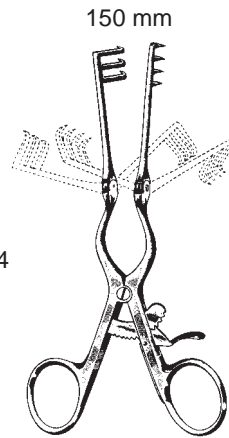

150 mm

19684-14

spitz
sharp
agudo

19685-14

stumpf
blunt
romo

ADSON
14 cm, 5 1/2"

Wundsperrer
Retractors
Separadores



stumpf
blunt
romo

PLESTER
19672-11
11 cm, 4 3/8"



stumpf
blunt
romo

PLESTER
19673-11
11 cm, 4 3/8"



stumpf
blunt
romo

WULLSTEIN
19675-13
13 cm, 5 1/8"



scharf
sharp
agudo

PLESTER
19677-10 10 cm, 4"
19677-13 13 cm, 5 1/8"

Wundhaken
Retractors
Separadores



19283-01

gerade
straight
recto

WILLIGER
12 cm, 4 3/4"



19283-02

links gebogen
left curved
curvado hacia la izquierda



19283-03

rechts gebogen
right curved
curvado hacia la derecha

Präparierscheren
Dissecting Scissors
Tijeras de disección



METZENBAUM
09280-15 09284-15 TC
15 cm 6"



METZENBAUM
09281-15 09285-15 TC
15 cm 6"



METZENBAUM FINO
09282-15 09286-15 TC
15 cm 6"



METZENBAUM FINO
09283-15 09287-15 TC
15 cm 6"

Präparierscheren
Dissecting Scissors
Tijeras de disección



— JOSEPH —
09304-14 14 cm 09305-14
5 1/2"



— STRABISMUS —
09370-11 09371-11
09374-11 TC 09375-11 TC
11 cm, 4 3/8"

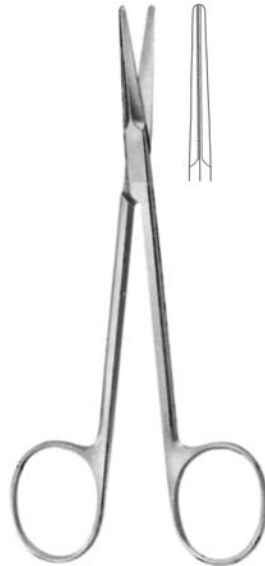

GORNEY
10050-12
12,5 cm, 5"

Chirurgische Scheren
Operating Scissors
Tijeras para cirugía



STANDARD

- 09110-11 11,5 cm, 4 ½"
- 09110-13 13,0 cm, 5"
- 09110-14 14,5 cm, 5 ¾"



STANDARD

- 09111-11 11,5 cm, 4 ½"
- 09111-13 13,0 cm, 5"
- 09111-14 14,5 cm, 5 ¾"

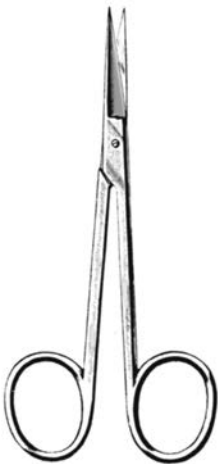

IRIS
11 cm, 4 ¾"



09340-11
09344-11 TC

gerade
straight
rectas



09341-11
09345-11 TC

gebogen
curved
curvas

Draht-, Blehschere
Wire and Plate Scissors
Tijeras para alambre y láminas



UNIVERSAL

09831-12 12 cm, 4 ¾"

09835-12 TC 12 cm, 4 ¾"

Mikro Scheren
Micro Scissors
Micro-Tijeras

10 mm

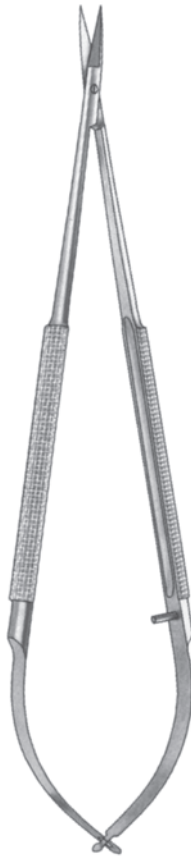

10202-14

14,5 cm, 5 $\frac{3}{4}$ "

10203-14

Messer
Knives
Cuchillos

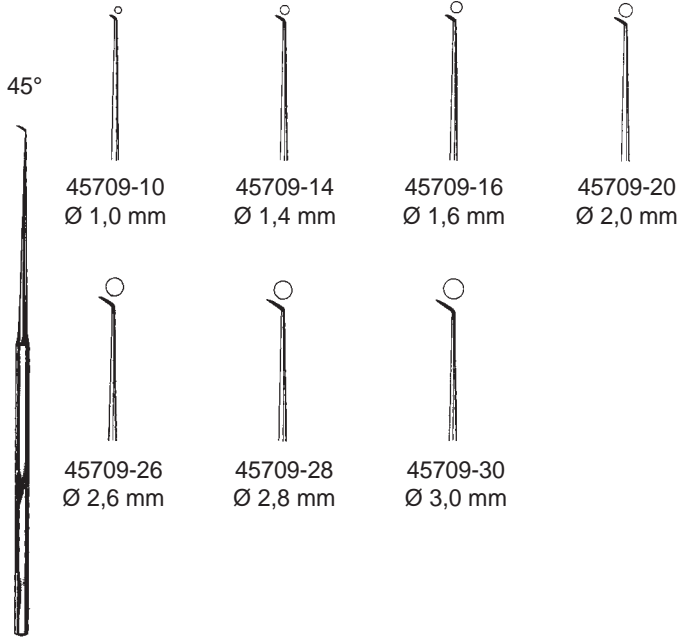

ROSEN
16 cm, 6 ¼"

90°



ROSEN
16 cm, 6 ¼"

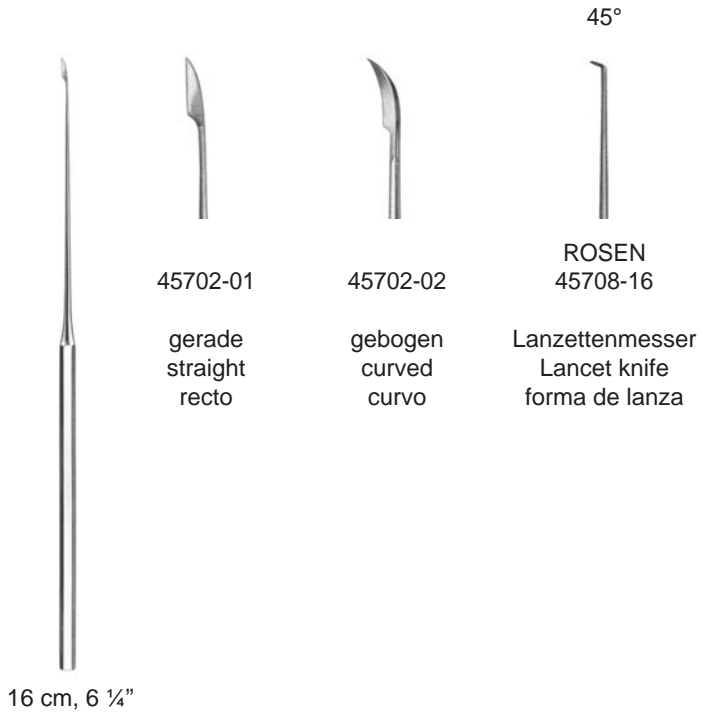

Messer
Knives
Cuchillos



SCHUKNECHT
45701-01
16 cm, 6 ¼"



SCHUKNECHT
45701-02
16 cm, 6 ¼"



SCHUKNECHT
45703-15
15,5 cm, 6"



WULLSTEIN
45704-15
15,5 cm, 6"



TABB
45705-15
15,5 cm, 6"



PLESTER
45706-35
15,5 cm, 6"

Mikro Nadelhalter
Micro Needle Holders
Micro-porta-agujas

ohne Sperre
without lock
sin cremallera

mit Sperre
with lock
con cremallera



BARRAQUER

11,5 cm, 4 1/2"
13,0 cm, 5 1/8"
14,0 cm, 5 1/2"
18,0 cm, 7"



25660-12
25660-13
25660-14
25700-18



25661-12
25661-13
25661-14
25701-18



25720-12
25720-13
25720-14
25730-18



25731-12
25731-13
25731-14
25731-18

mit diamantiertem Maul
with diamond jaw
con boca de diamante

11,5 cm, 4 1/2"
13,0 cm, 5 1/8"
14,0 cm, 5 1/2"
18,0 cm, 7"

25720-12D
25720-13D
25720-14D
25730-18D

25671-12D
25671-13D
25671-14D
25731-18D

T= Titan, titanium, titanio



93250-15T
93250-18T



93251-15T
93251-18T



93260-15T
93260-18T



93261-15T
93261-18T

15,0 cm, 6"
18,0 cm, 7"

Mikro Nadelhalter mit Sperre
 Micro Needle Holders, with Lock
 Micro-porta-agujas con cremallera



14,0 cm, 5 ½"
 18,0 cm, 7"



25670-14
 25670-18



25671-14
 25671-18



25672-14
 25672-18



25673-14
 25673-18

mit TC 1,4 mm
 with TC jaw 1,4 mm
 con TC 1,4 mm

14,0 cm, 5 ½"
 18,0 cm, 7"

25674-14	25675-14	25676-14	25677-14
25674-18	25675-18	25668-18	25691-18

mit diamantiertem Maul 0,8 mm
 with diamond jaw 0,8 mm
 con boca de diamante 0,8 mm

14,0 cm, 5 ½"
 18,0 cm, 7"

25672-14D	25673-14D
25672-18D	25673-18D

T= Titan, titanium, titanio
 Maul / jaw / boca 0,4mm

14,0 cm, 5 ½"
 18,0 cm, 7"

25672-14T	25673-14T
25672-18T	25673-18T

CASTROVIEJO

Saugrohre
Suction Tubes
Tubos de aspiración

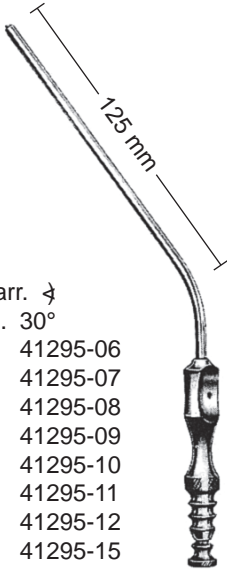

Charr. ↴
F.G. 30°

- 6 41295-06
- 7 41295-07
- 8 41295-08
- 9 41295-09
- 10 41295-10
- 11 41295-11
- 12 41295-12
- 15 41295-15

FRAZIER/FERGUSSON
19 cm, 7 1/2"

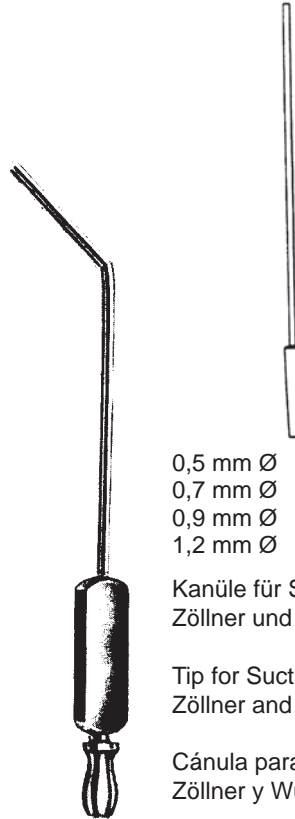

- 0,5 mm Ø 41306-05
- 0,7 mm Ø 41306-07
- 0,9 mm Ø 41306-09
- 1,2 mm Ø 41306-12

Kanüle für Sauggriff
Zöllner und Wullstein

Tip for Suction Handle
Zöllner and Wullstein

Cánula para mango
Zöllner y Wullstein

ZÖLLNER
41302-02

Saugrohre
Suction Tubes
Tubos de aspiración

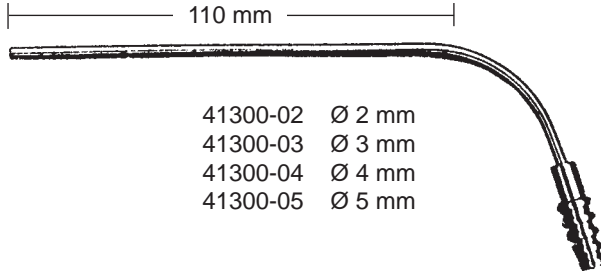

41300-02 Ø 2 mm
41300-03 Ø 3 mm
41300-04 Ø 4 mm
41300-05 Ø 5 mm

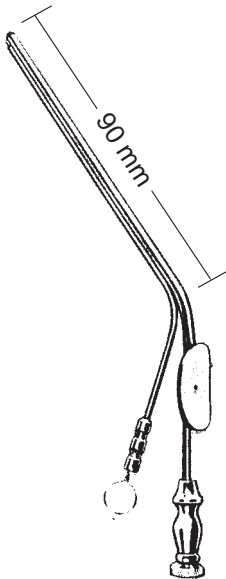

HOUSE

9 cm, 3 1/2"

41303-09 Ø 0,9 x 0,7 mm
41303-12 Ø 1,2 x 0,9 mm
41303-15 Ø 1,5 x 1,2 mm
41303-18 Ø 1,8 x 1,8 mm
41303-25 Ø 2,5 x 2,0 mm
41303-30 Ø 3,0 x 2,0 mm
41303-45 Ø 4,5 x 2,0 mm



PLESTER 30°

Charr. 6 41304-06
Charr. 8 41304-08
Charr. 10 41304-10

Saugrohre
Suction Tubes
Tubos de aspiración

Mikro-Saugkanüle
Micro suction cannula
Micro tubo de aspiración

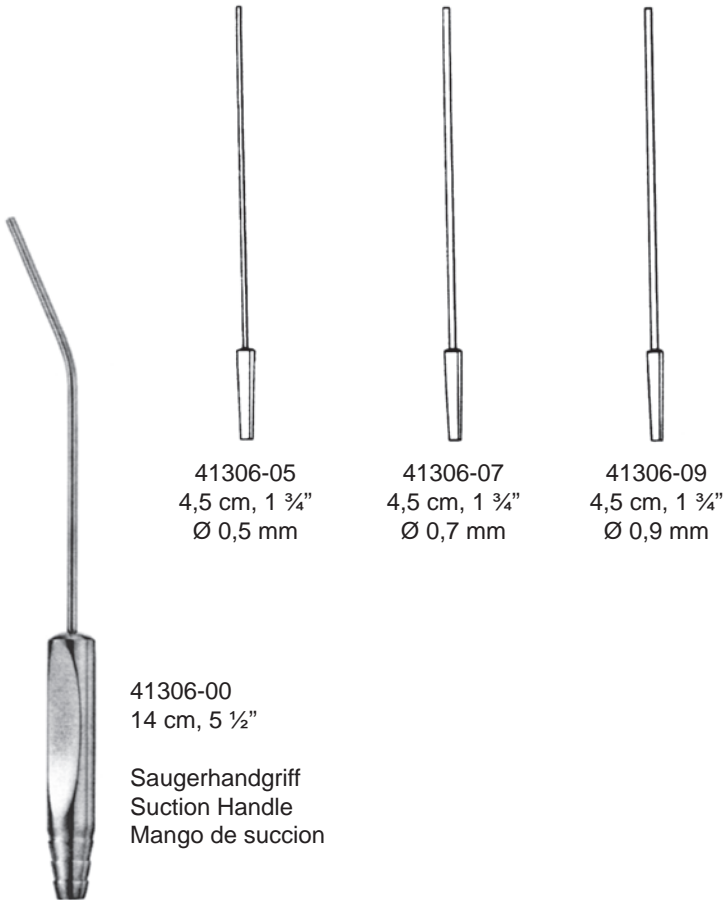

41306-05
4,5 cm, 1 3/4"
Ø 0,5 mm

41306-07
4,5 cm, 1 3/4"
Ø 0,7 mm

41306-09
4,5 cm, 1 3/4"
Ø 0,9 mm

41306-00
14 cm, 5 1/2"

Saugerhandgriff
Suction Handle
Mango de succion

WULLSTEIN
41308-00

komplett, mit Griff und drei Aufsätzen
complete, with handle and 3 tips
completo, con mango y 3 puntas

Saugrohre
Suction Tubes
Tubos de aspiración

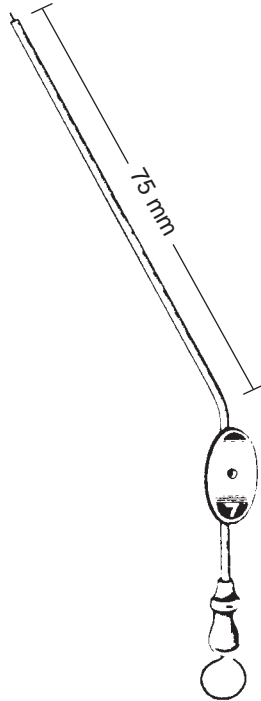

BARON

16 cm, 6 ¼"

41299-03	3FR	1,0 mm
41299-05	5FR	1,6 mm
41299-07	7FR	2,3 mm

Saug- und Spülinstrumente
Aspirating and Irrigation Instruments
Instrumentos de aspiracion y irrigacion

LUER



Sauggriff
Suction Handle
Mango de succion

WULLSTEIN
41307-00

Saugadapter
mit Saugunterbrecher

Suction adapter
with finger cut-off

Adaptador para
aspiración con interrupto

LUER



HOUSE
41300-00
5,5 cm, 2 1/4"



Kanüle für Sauggriff
Tip for Suction Handle
Cánula para mango de succion

ROSEN
10 cm, 4"

0,5 mm Ø 41305-05	1,2 mm Ø 41305-12
0,6 mm Ø 41305-06	1,5 mm Ø 41305-15
0,7 mm Ø 41305-07	1,8 mm Ø 41305-18
0,8 mm Ø 41305-08	2,0 mm Ø 41305-20
0,9 mm Ø 41305-09	2,5 mm Ø 41305-25
1,0 mm Ø 41305-10	3,0 mm Ø 41305-30

Knorpelfeile
Cartilage Files
Limas para el cartilago

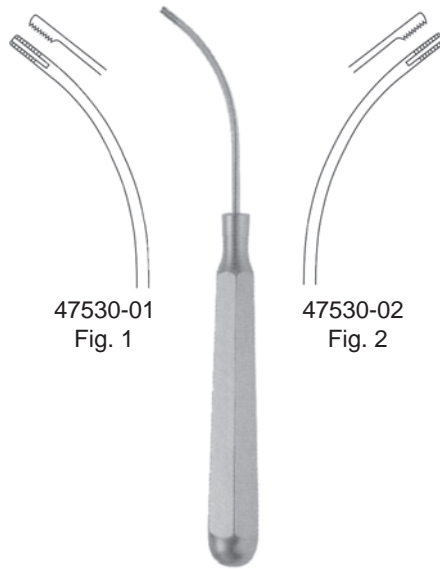

47530-01
Fig. 1

47530-02
Fig. 2

DINGMAN Set
47530-00 15 cm, 6"

Mikro Scheren und Mikro Zangen
 Micro Scissors and Forceps
 Micro tijeras y pinzas

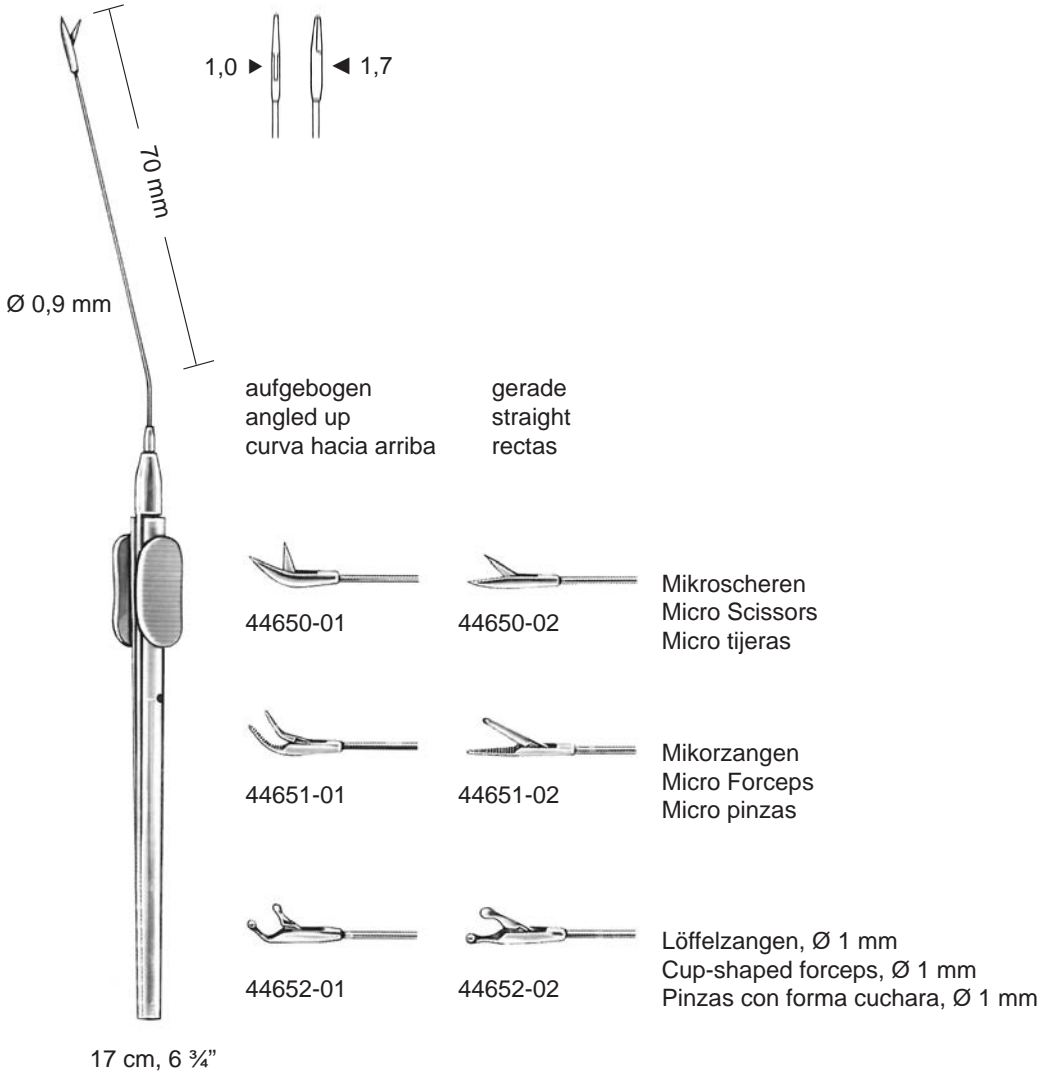

Mikro Meßsonde
Micro Measuring Rod
Sonda para mesurar



HOUSE
16 cm, 6 ¼"

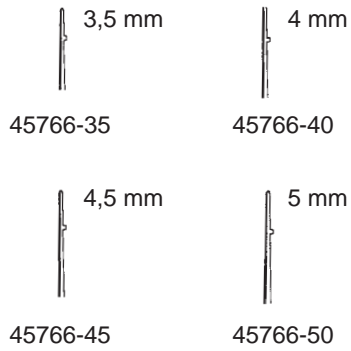

Mikro Küretten
Micro Curettes
Micro curetas

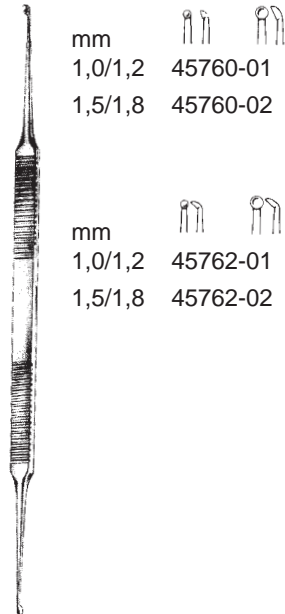

mm
1,0/1,2 45760-01
1,5/1,8 45760-02

mm
1,0/1,2 45762-01
1,5/1,8 45762-02

HOUSE
15 cm, 6"

Scharfer Löffel
Sharp Spoon
Cucharilla cortante

1,5 x 2,5 mm



SHEA
45770-01
16 cm, 6 ¼"

Nadeln und Häkchen
Needles and Hooks
Agujas y Ganchos



16 cm, 6 1/4"



BARBARA /
ROSEN
45710-15



BARBARA /
ROSEN
45711-15

stumpf
blunt
roma



BARBARA /
ROSEN
45713-15



BARBARA /
ROSEN
45715-17



25°
SHAMBAUGH



45°
SHAMBAUGH



90°
SHAMBAUGH



BARBARA
45725-05 0,5 mm
45725-10 1,0 mm

mm
0,3
0,6
1,0
1,2
1,5
2,0
2,5

45720-03
45720-06
45720-10





45722-03
45722-04
45722-06
45722-08
45722-10
45722-12
45722-15
45722-20
45722-25

45724-03
45724-04
45724-06
45724-08
45724-10
45724-12
45724-15
45724-20
45724-25





Nadeln und Hakchen
 Needles and Hooks
 Agujas y Ganchos



15,5 cm, 6"

					
mm	90°	90°	mm	McGEE	McGEE
0,3	45730-03	45732-03	0,5	45733-05	45735-05
0,6	45730-06	45732-06	1,0	45733-10	45735-10
1,0	45730-10	45732-10			

		
BARBARA	ROSEN	
45736-15	45737-15	

				
mm	25°	25°	45°	45°
0,3	45741-03	45743-03	45745-03	45747-03
0,6	45741-06	45743-06	45745-06	45747-06
1,0	45741-10	45743-10	45745-10	45747-10



45746-20
abgewinkelt
angled
angulado



45748-16
retrograd schneidend
reverse cutting
ganchito, corte retrogrado

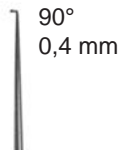

45749-16
abgewinkelt, oval
angled, oval-blunt
angulado, ovalado



45750-16
abgewinkelt, zylindrisch
angled, cylindric
angulado, cilíndrico



45770-16
abgewinkelt, zylindrisch
angled, cylindric
angulado, cilíndrico



45771-16
Führungsgabel
Guide fork
Horquilla de guía



16 cm, 6 1/4"

Elevatorium, Raspatorium, Löffel
Elevators, Raspatories, Spoon
Elevadores, Periostótomos, Cucharilla

1,0 mm



45756-10
Elevatorium
Elevators
Elevador



45756-20
1,0 mm
45756-30
1,2 mm
Raspatorien
Raspatories
Periostótomos

1,8 mm



45756-50
Raspatorium stark gebogen
Raspatories strongly curved
Periostótomos fuertemente curvado



45756-40
Löffel leicht gebogen
Spoon slightly bent
Cucharilla ligeramente curvada



16,5 cm, 6 1/2"



Reda Instrumente GmbH
Gänsäcker 34 - P.O. Box 131
D-78532 Tuttlingen

**RHINOLOGIE
SINUSKOPIE**

**RHINOLOGY
SINUSCOPY**

**RINOLOGÍA
SINUSCOPIA**



www.Reda-Instrumente.de

Indikationen und Kontraindikationen finden Sie in der entsprechenden Gebrauchsanweisung!

Indication and Contraindication please refer to our user's manual!

Indicaciones y Contraindicaciones se encuentran en la instrucciones de uso correspondientes!

Nasenspekula
Nasal Specula
Espéculos nasales

selbsthaltend
self-retaining
autoestático



THUDICHUM
6,5 cm, 2 1/2"



47050-01
Fig. 1



47050-02
Fig. 2



47050-03
Fig. 3



47050-04
Fig. 4

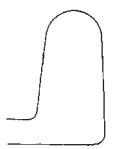

47050-05
Fig. 5

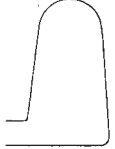

47050-06
Fig. 6



47050-07
Fig. 7

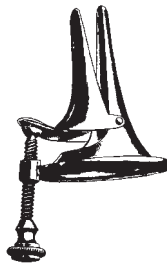

VOLTOLINI



47060-01



47060-02



47060-03

Nasenspekula
Nasal Specula
Espéculos nasales



HARTMANN-HALLE
15 cm, 6"

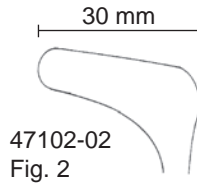

Nasenspekula
Nasal Specula
Espéculos nasales



HARTMANN
16 cm, 6 ¼"

30 mm

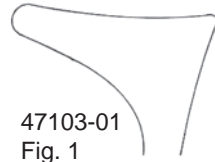

47103-01
Fig. 1

33 mm

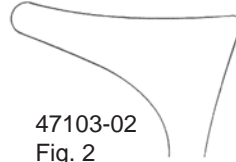

47103-02
Fig. 2

35 mm



47103-03
Fig. 3

Nasenspekula
Nasal Specula
Espéculos nasales

leichtes Modell
lightweight
modelo ligero

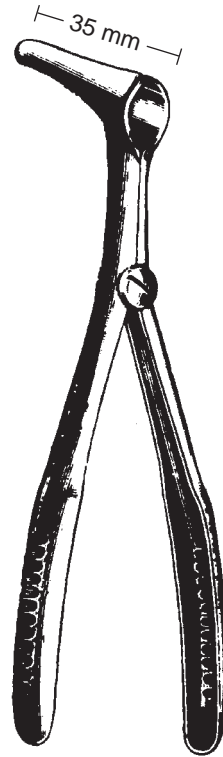
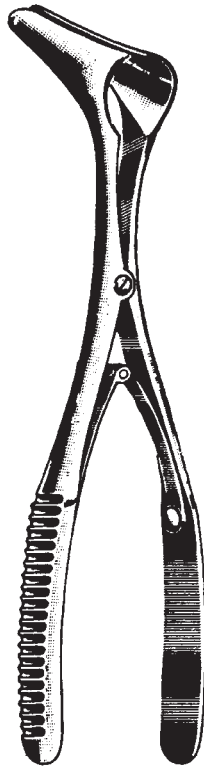

Mod. WIEN
14 cm, 5 ½"

Mod. WIEN
14 cm, 5 ½"

Baby, bebé	47112-01	25 mm
Kind, child, niño	47112-02	30 mm
Erwachs., adult, adulto	47112-03	35 mm

Nasenspekula
 Nasal Specula
 Espéculos nasales

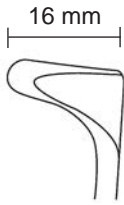

47116-13

für Säuglinge
 for babies
 para bebés

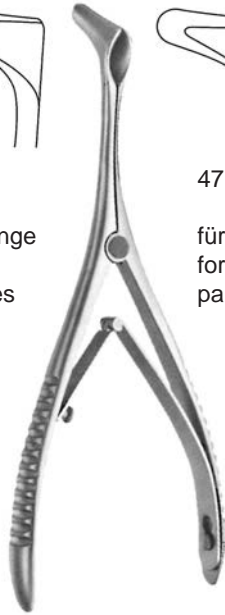

TIECK-HALLE
 13,5 cm, 5 3/4"



47116-14

für Kleinkinder
 for infants
 para niños



REDA
 47118-13
 12,5 cm, 5"

47120-35
 35 mm

47120-50
 50 mm

47120-75
 75 mm

47120-90
 90 mm



KILLIAN
 13 cm, 5 1/8"



Nasenspekula
Nasal Specula
Espéculos nasales



KILLIAN
13 cm, 5 1/8"

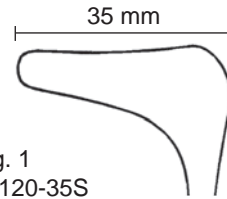

Fig. 1
47120-35S

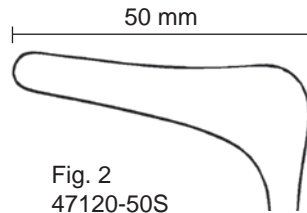

Fig. 2
47120-50S

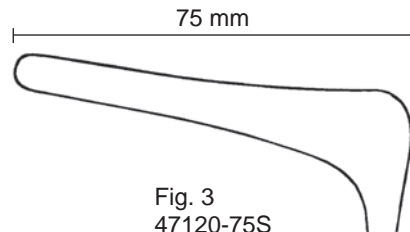

Fig. 3
47120-75S

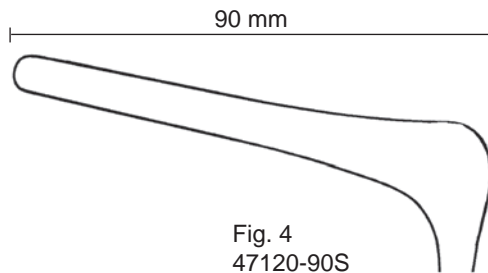

Fig. 4
47120-90S

Nasenspekula
Nasal Specula
Espéculos nasales



COTTLE
14 cm, 5 ½"

35 mm

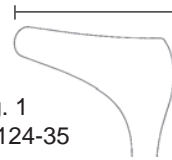

Fig. 1
47124-35

50 mm

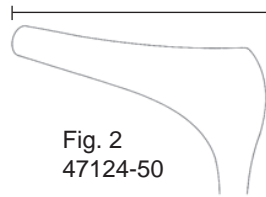

Fig. 2
47124-50

75 mm

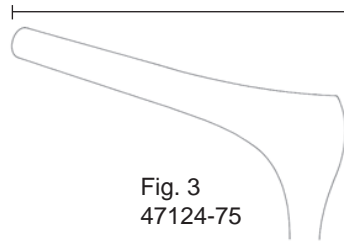

Fig. 3
47124-75

90 mm

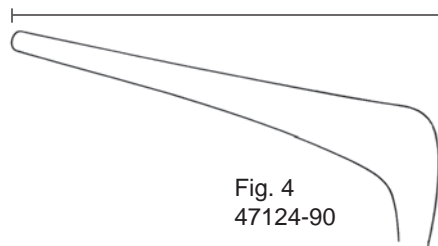

Fig. 4
47124-90

Nasenspekula
Nasal Specula
Espéculos nasales

35 mm

Fig. 1
47124-35S

50 mm

Fig. 2
47124-50S

75 mm

Fig. 3
47124-75S

90 mm

Fig. 4
47124-90S



COTTLE
14 cm, 5 ½"

LEYLA Retraktor System
LEYLA Retractor System
Separador de sistema LEYLA



41843-50

Kugelgelenkkloben zum Befestigen an der OP-Tischschiene und zur Aufnahme des Haltearms 41850-41

ball and socket joint for fixation of holding rod 41850-41 at the operating table

articulacion esferica, para sujetar el brazo de soporte rigido sobre la mesa de operaciones 9 x 32 mm



41850-41

starrer Haltearm, auseinandernehmbar, zur Fixation im Kugelgelenkkloben 41843-50 und zur wahlweisen Aufnahme des Kupplungskopf

holding rod, detachable, for fixation in ball and socket joint 41843-50 and to hold a desired coupling head

brazo de soporte rigido, desmontable, para fijacion a la articulacion esferica 41843-50 y opcionalmente a las cabezas

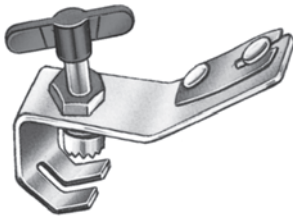

41821-21

Fixiervorrichtung zum Befestigen an Rohrteilen bis \varnothing 16 mm

clamp for fixation on bars up to \varnothing 16 mm

dispositivo de fijacion para tubos hasta \varnothing 16 mm



41842-44

Kupplungskopf, drehbar, zur Aufnahme von 1 flexiblenSpannarm 41810-10

coupling head, turnable, to hold 1 flexible arm 41810-10

acoplamiento, para fijacion de un brazo flexible 41810-10

Nasenpinzetten
Nasal Forceps
Pinzas nasales

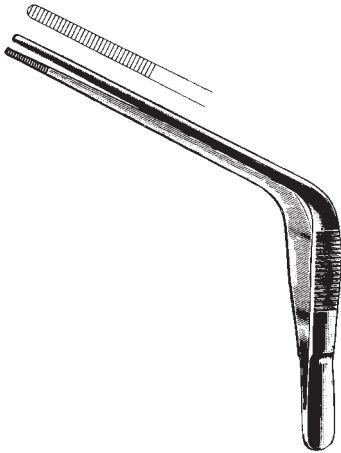

TROELTSCH
47151-15
15 cm, 6"

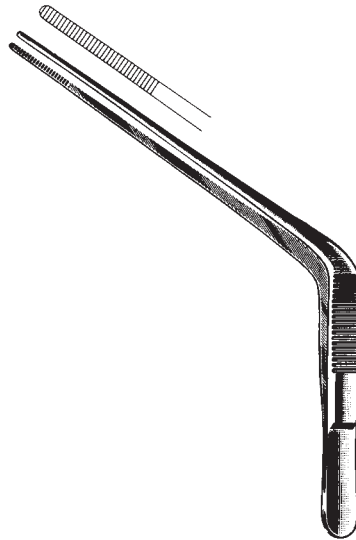

TROELTSCH
47151-18
18 cm, 7"

Nasenpinzetten
Nasal Forceps
Pinzas nasales



JANSEN-GRUENWALD
47154-20
20 cm, 8"

1x2



JANSEN
47155-20
20 cm, 8"

Nasenpinzetten
Nasal Forceps
Pinzas nasales



GRAEFE
11190-10 10,5 cm, 4.1"



McINDOE
11258-15 15,0 cm, 6"
11259-15 TC 15,0 cm, 6"



1x2

GILLIES
11272-15 15,5 cm, 6"
11273-15 TC 15,5 cm, 6"

Nasenpinzetten
 Nasal Forceps
 Pinzas nasales

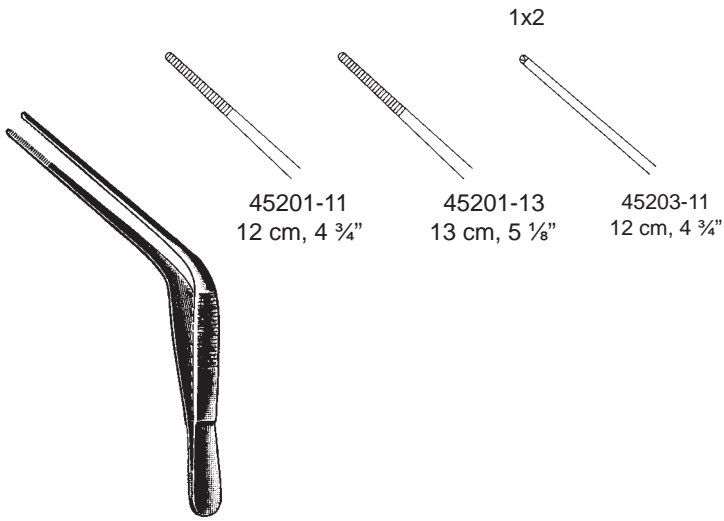

45201-11
 12 cm, 4 3/4"

45201-13
 13 cm, 5 1/8"

45203-11
 12 cm, 4 3/4"

1x2

WILDE (TROELTSCH)

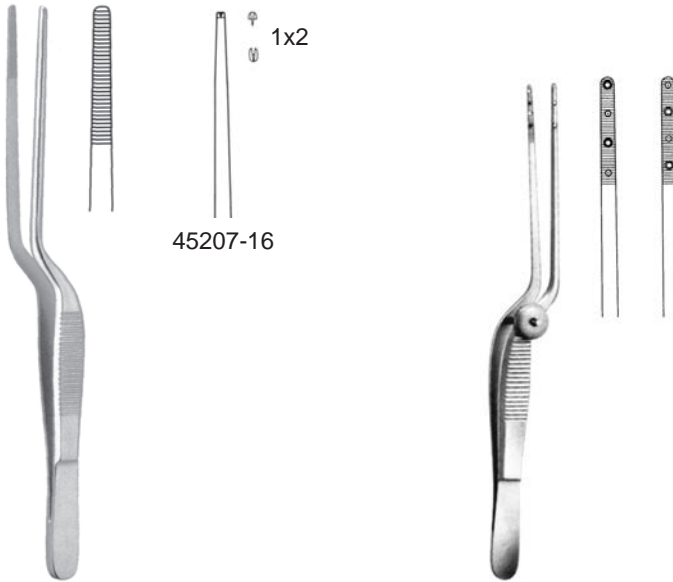

45207-16

1x2

LUCAE

45206-14 14 cm, 5 1/2"
 45206-16 16 cm, 6 1/4"

COTTLE

45208-14
 14 cm, 5 1/2"

Columella-Pinzette
Columella Forceps
Pinzas para columnela

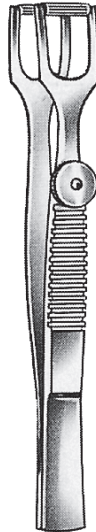

COTTLE
47565-10
10 cm, 4"

Nasentamponzangen
Nasal Dressing Forceps
Pinzas nasales para taponamiento



WESTMACOTT
47158-20 20 cm, 8"



LUBET-BARBON
47159-20 20 cm, 8"



HARTMANN
47161-16 16 cm, 6 1/4"



HARTMANN
47161-20 20 cm, 8"

Nasentamponzangen
Nasal Dressing Forceps
Pinzas nasales para taponamiento



LISTER (Sinus)
17210-13 13 cm, 5 1/8"
17210-16 16 cm, 6 1/4"
17210-18 18 cm, 7"

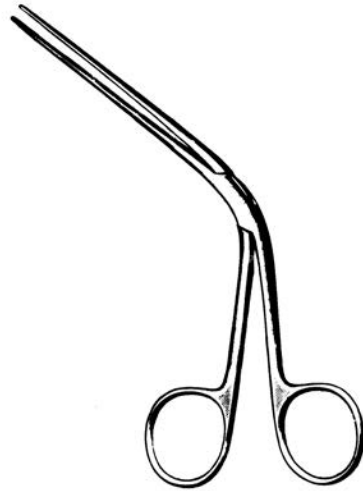

TILLEY
45243-14
14 cm, 5 1/2"

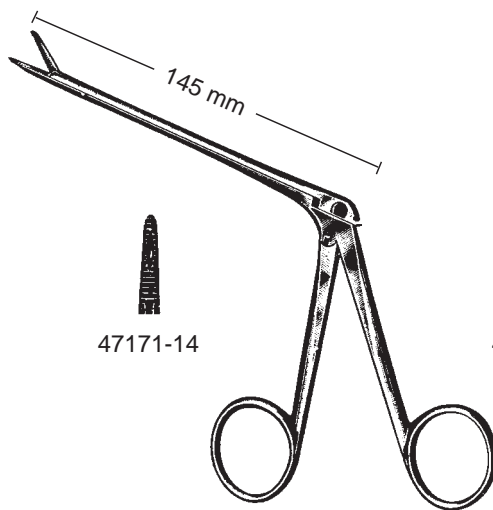

NOYES
14,5 cm, 5 3/4"

Polypenzangen
Nasal Polypus Forceps
Pinzas para pólipos

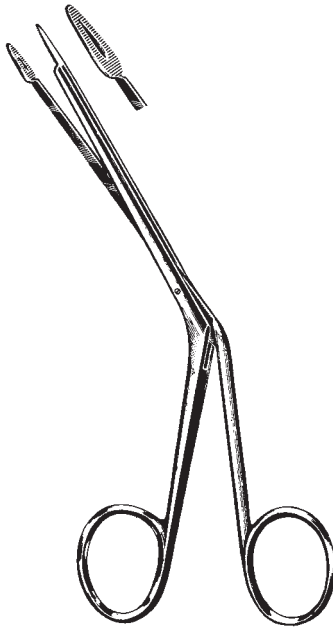

LITTAUER
47167-18
18 cm, 7"

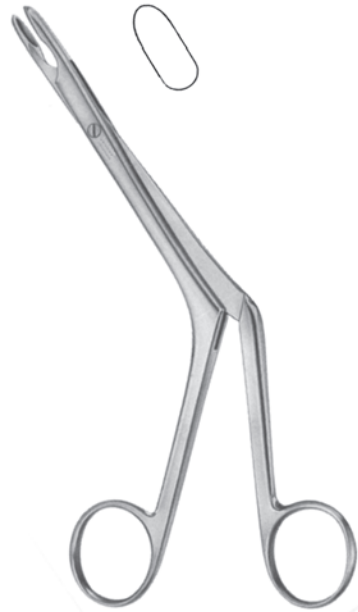

HEYMANN-KNIGHT
47169-18
18 cm, 7"

Nasen Septumzangen
Nasal Septum Forceps
Pinzas para el tabique nasal

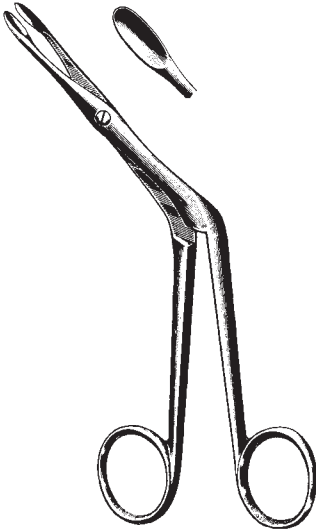

HEYMANN
47181-18
18 cm, 7"



KNIGHT
47185-18
18 cm, 7"

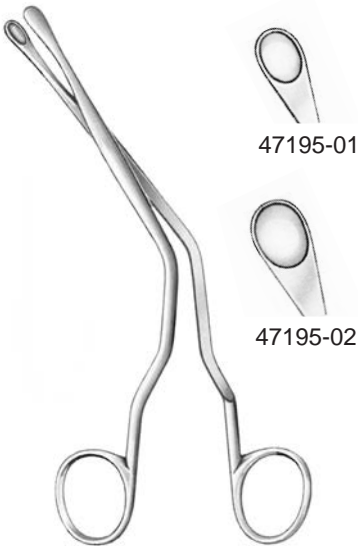

47195-01



47195-02

LUC
19 cm, 7 1/2"

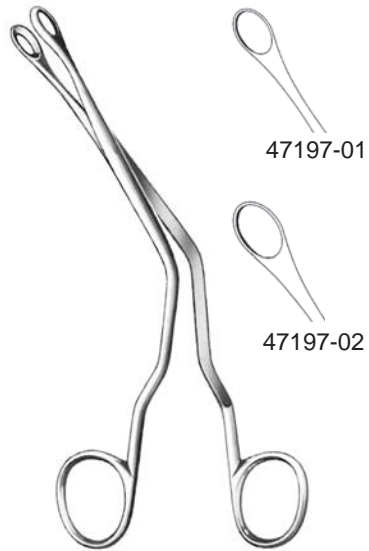

47197-01



47197-02

LUC
19 cm, 7 1/2"

Nasen Septumzangen
Nasal Septum Forceps
Pinzas para el tabique nasal



BRUENINGS
19 cm, 7 1/2"

Vomerzange
Vomer Forceps
Pinza para el vómer



CRAIG
47192-18
18 cm, 7"

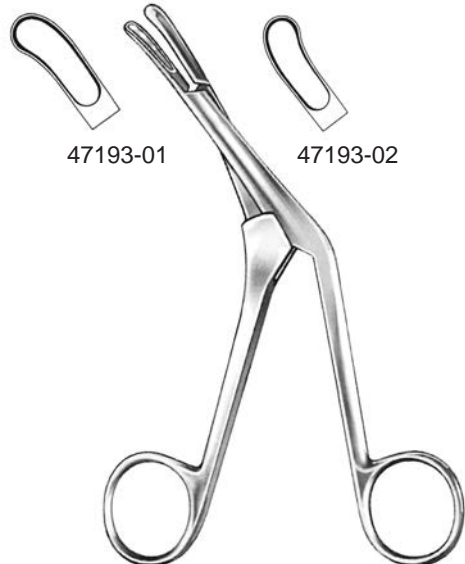

CRAIG-DOMNICK
17 cm, 6 3/4"

Nasen Septumzangen
Nasal Septum Forceps
Pinzas para el tabique nasal



MIDDLETON-JANSEN
47323-19
19 cm, 7 ½"



MIDDLETON-JANSEN
47325-19
19 cm, 7 ½"

Septumrichtzangen
Septum Straightening Forceps
Pinza para enderezar el tabique nasal



ASCH
47571-23
23 cm, 9"



WALSHAM
47572-23
23 cm, 9"

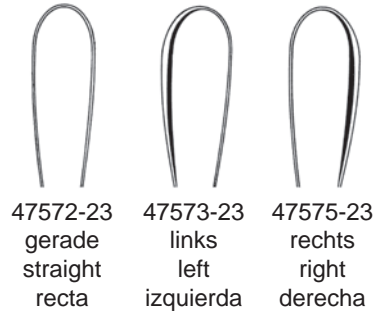

Quetschzange
Morselizer Forceps
Pinza para aplastar



RUBIN
47251-21
21 cm, 8 ¼"

Polypenschnürer
Nasal Polypus Snares
Polipótomos



KRAUSE-VOSS
47350-26
26 cm, 10 ¼"



KRAUSE
47351-26
26 cm, 10 ¼"

Polypenschnürer
Nasal Polypus Snares
Polipótomos

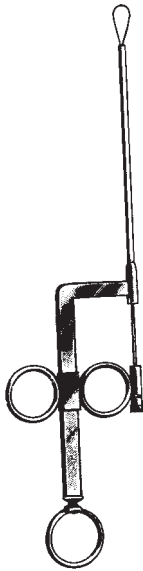

WILDE
47352-24
24 cm, 9 1/2"









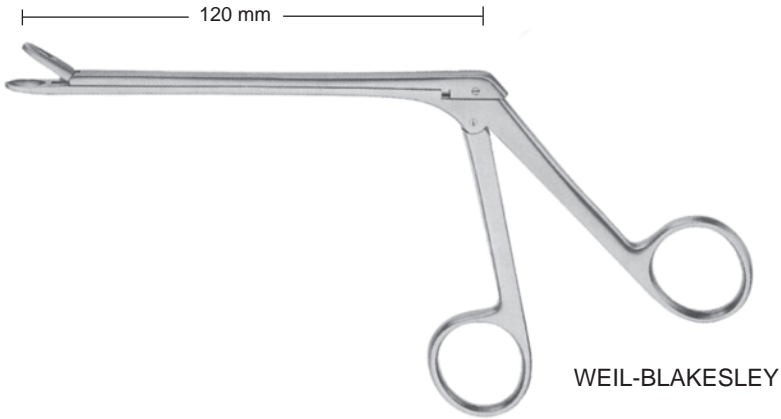

Bündel mit 12 Stück
Bundle of 12 pieces
paquete de 12 piezas

47355-03 0,3 mm

Siebbeinzangen
Ethmoid Forceps
Pinzas para etmoides



						
	Fig. 0	Fig.1	Fig. 2	Fig.3	Fig.4	Fig. 5
	47223-00 2,5 mm	47223-01 3,0 mm	47223-02 3,6 mm	47223-03 4,2 mm	47223-04 4,8 mm	47223-05 5,8 mm
	47224-00 2,5 mm	47224-01 3,0 mm	47224-02 3,6 mm	47224-03 4,2 mm	47224-04 4,8 mm	47224-05 5,8 mm
		47225-01 3,0 mm	47225-02 3,6 mm	47225-03 4,2 mm	47225-04 4,8 mm	

Siebbeinzangen
Ethmoid Forceps
Pinzas para etmoides

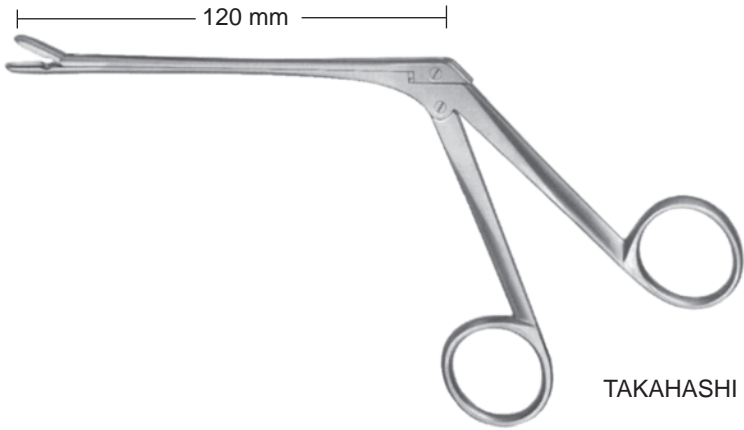

2,5 mm



47241-00

4 mm



47242-00

4 mm



47242-01

Siebbeinzangen
Ethmoid Forceps
Pinzas para etmoides

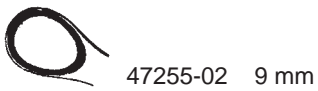
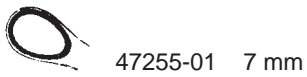
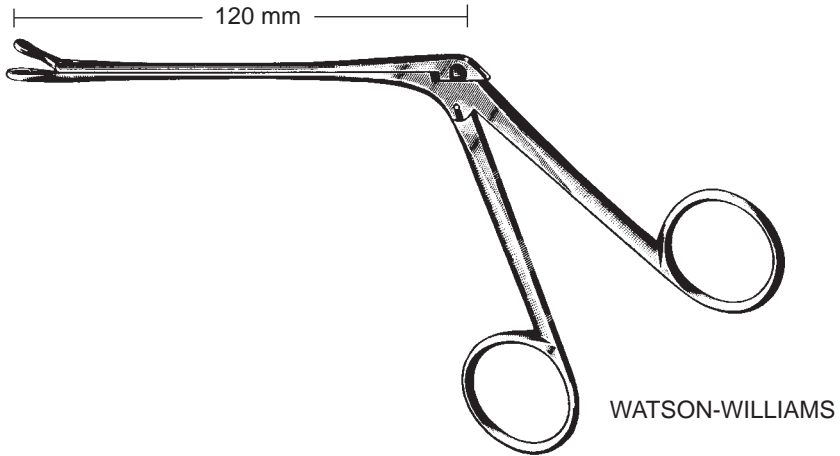

Nasenzange
Nasal Forcep
Pinza nasal

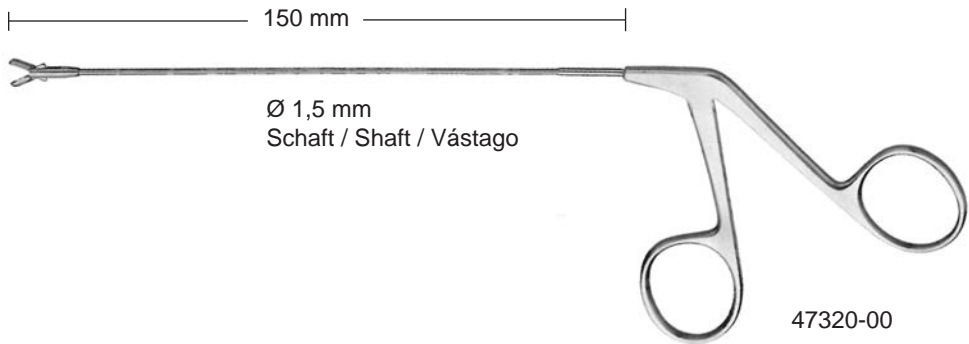

3 x 5 mm



Biopsiezange mit Löffelmaul
Biopsy Forceps with cup jaw
Pinza para biopsia con boca en forma de cucharilla

Nasenzangen, durchschneidend
Nasal Cutting Forceps
Pinzas nasales cortantes

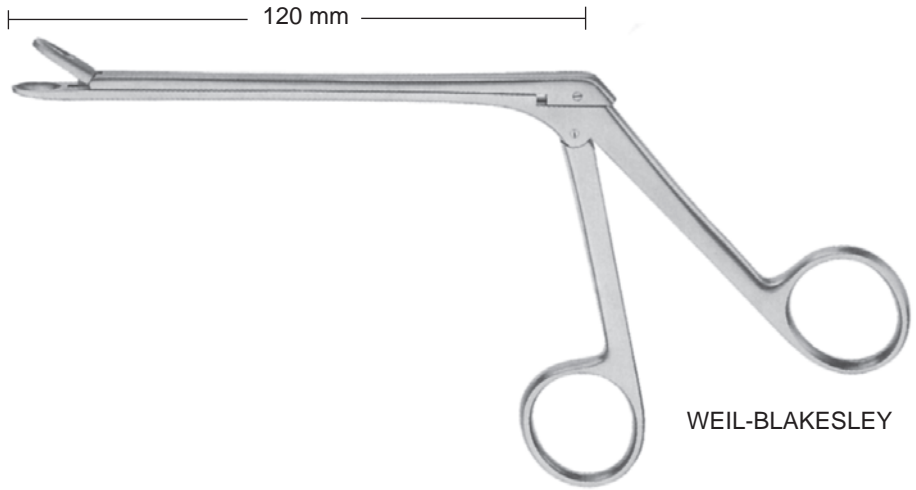

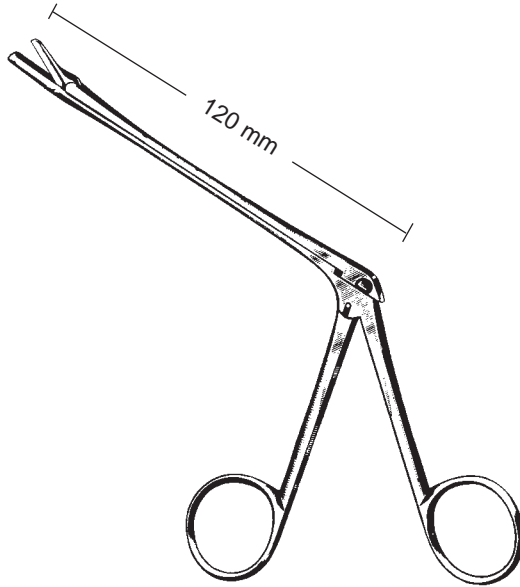

	47226-01 2,0 mm	47226-02 2,5 mm	47226-03 3,0 mm
	47227-01 2,0 mm	47227-02 2,5 mm	47227-03 3,0 mm

Nasenzangen, durchschneidend
Nasal Cutting Forceps
Pinzas nasales cortantes



STRUYCKEN
47240-19

 47235-05
5 mm

 47235-07
7 mm

 47235-09
9 mm

 47235-11
11 mm



HARTMANN

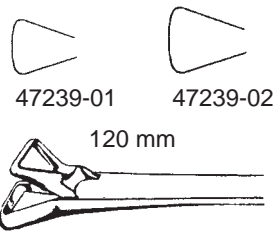

SCHMEDEN

Scharfe Nasenzangen, durchschneidend
 Nasal Cutting Forceps
 Pinzas nasales cortantes

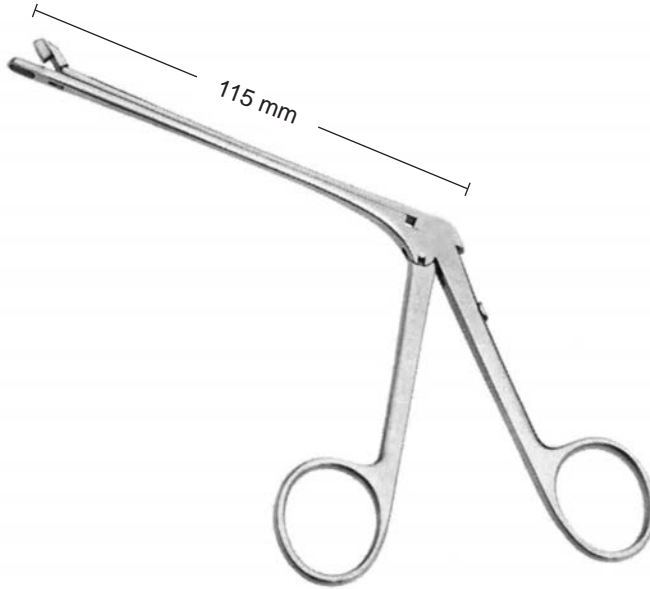

gerade
 straight
 recta



47230-00
 2,7 x 6,8 mm



47230-01
 3 x 7,7 mm

aufgewinkelt
 angled up
 angulada hacia arriba



47230-02
 2,2 x 6,5 mm



47230-03
 2,6 x 6,5 mm



47230-04
 3 x 6,5 mm

fein, gerade
 delicate, straight
 fina, recta



47230-05
 1,4 x 5 mm

fein, aufgewinkelt
 delicate, angled up
 fina, angulada hacia arriba



47230-06
 1,4 x 4 mm

Scharfe Nasenzangen
Nasal Cutting Forceps
Pinzas nasales cortantes

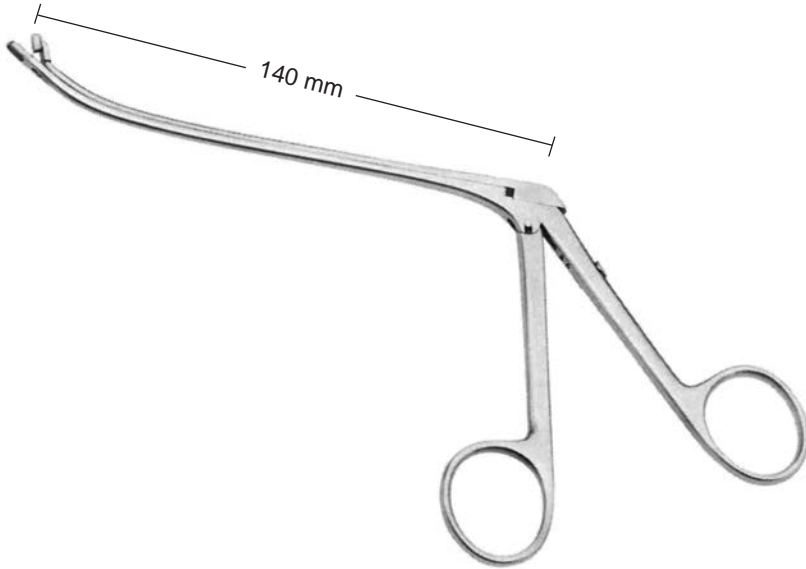

47231-00
3 x 7,4 mm

aufgebogen
curved up
curvada hacia arriba



47231-01
1,4 x 5 mm

fein, aufgebogen
delicate, curved up
fina, curvada hacia arriba



47231-02
1,4 x 4 mm

fein, aufgebogen, gewinkelt
delicate, curved up, angled
fina, curvada hacia arriba, angulada

Scharfe Nasenzange
Nasal Cutting Forcep
Pinza nasal cortante

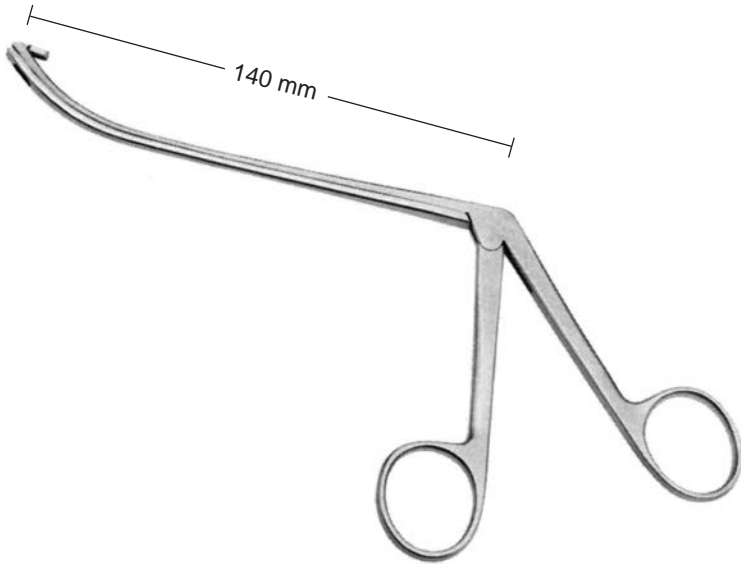

47232-00
2,6 x 4,5 mm

rückwärts schneidend, aufgebogen
backward cutting, curved up
corte retrogrado, curvada hacia arriba

Scharfe Nasenzangen
Nasal Cutting Forceps
Pinzas nasales cortantes



47233-00
3 x 5 mm

fein, gerade
delicate, straight
fina, recta



47233-01
3 x 5 mm

fein, aufgewinkelt
delicate, angled
fina, angulada hacia arriba

Scharfe Nasenzangen
Nasal Cutting Forceps
Pinzas nasales cortantes

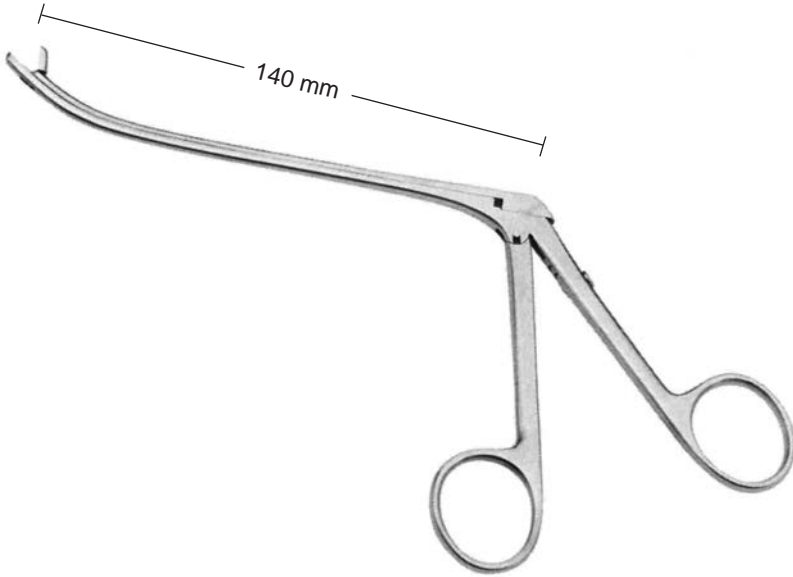

47233-02
4 x 5 mm

aufgebogen
curved up
curvada hacia arriba



47233-03
3 x 5 mm

fein, aufgebogen
delicate, curved up
fina, curvada hacia arriba

Fremdkörperzängchen
Ear Polypus Forceps
Pinzas para pólipos

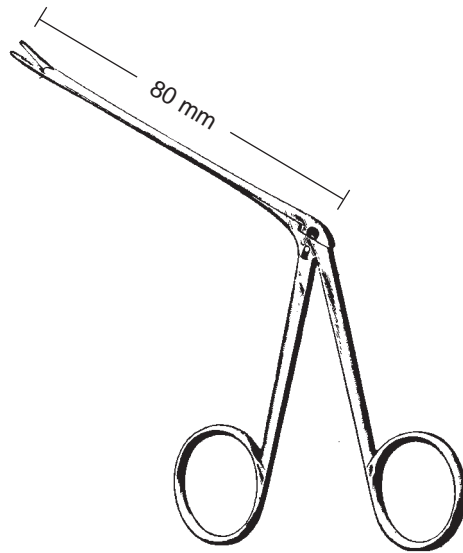

◦ 1 mm Ø



HARTMANN-WULLSTEIN
45257-08
8,5 cm, 3.4"

○ 2 mm Ø



Ø mm	HARTMANN
2,0	45267-20 8,5 cm, 3.4"
2,5	45267-25 8,5 cm, 3.4"



HARTMANN-HOFFMANN
45275-08
8,5 cm, 3.4"

Kieferhöhlen-Fasszange
Maxillary Sinus Forceps
Pinza de agarre para el seno maxilar

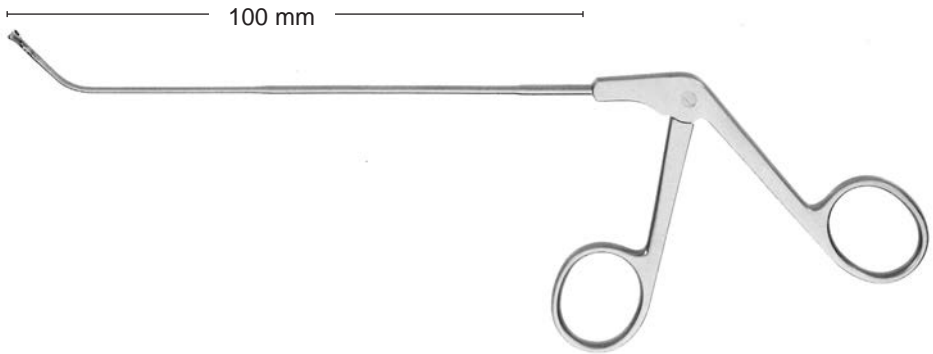

Maulteil starr
Jaw rigid
Boca rigida



47324-01
90° rückwärts öffnend nach unten
90° backward opening downwards
apertura de 90° hacia atrás hacia abajo



47324-02
120° rückwärts öffnend nach unten
120° backward opening downwards
apertura de 120° hacia atrás hacia abajo

Kieferhöhlen-Fasszange
Maxillary Sinus Forceps
Fórceps del seno maxilar

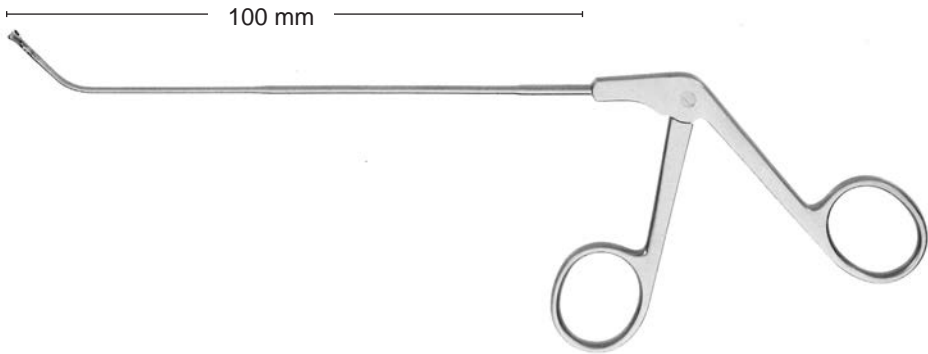

Maulteil starr
Jaw rigid
Boca rigida



47324-05
90° rückwärts öffnend nach oben
90° backward opening top
apertura de 90° hacia atrás hacia arriba



47324-04
90° rückwärts öffnend nach rechts
90° backward opening right
apertura de 90° hacia atrás hacia la derecha



47324-03
90° rückwärts öffnend nach links
90° backward opening left
apertura de 90° hacia atrás hacia la izquierda

Nasenzangen, durchschneidend
 Nasal Cutting Forceps
 Pinzas nasales cortantes

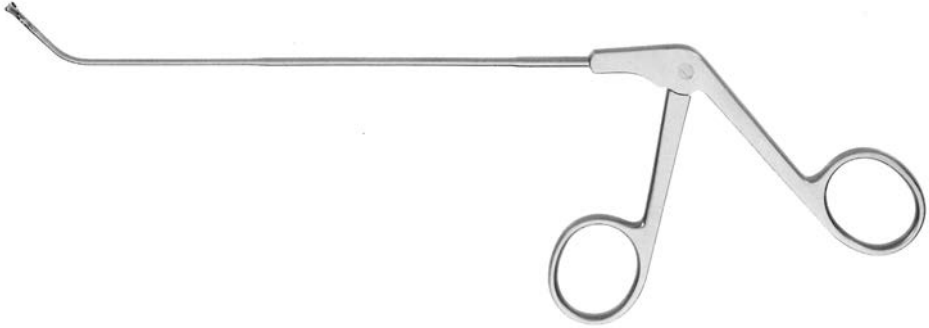

nach oben gebogen
 curved upward
 curvada hacia arriba



Doppellöffel, horizontal öffnend
 Cup, double action horizontal jaw
 Boca en forma cuchara de doble accion, boca horizontal

	70°	90°	110°
Ø 2 mm	47316-70	47316-90	47316-11
Ø 3 mm	47317-70	47317-90	47317-11
Ø 4 mm	47320-70	47320-90	47320-11



Doppellöffel, vertikal öffnend
 Cup, double action vertical jaw
 Boca en forma cuchara de doble accion, boca vertical

	70°	90°	110°
Ø 2 mm	47321-70	47321-90	47321-11
Ø 3 mm	47318-70	47318-90	47318-11
Ø 4 mm	47322-70	47322-90	47322-11





Doppellöffel BUTTERFLY, horizontal öffnend
 BUTTERFLY cup, double action horizontal jaw
 Boca en forma cuchara de doble accion BUTTERFLY,
 boca horizontal

	80°	100°
Ø 3 mm	47323-80	47323-10

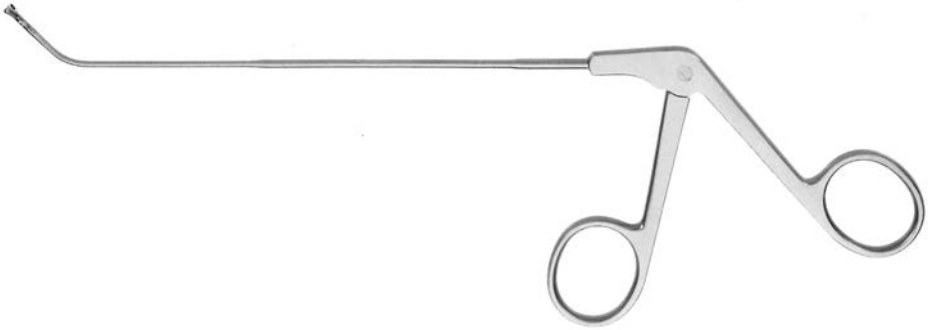
Biopsie Stanze
Biopsy Punch
Pinza para biopsia





Biopsie Stanze, Schnitt 2,5 x 5 mm, einfach vertikalen Kiefer
Biopsy punch, cut 2.5 x 5 mm, single action vertical jaw
Pinza para biopsia, corte de 2,5 x 5 mm, boca vertical de simple accion

	Schaft Shaft Vástago	vertikal öffnend vertical opening apertura vertical	links öffnend left opening apertura a la izquierda	rechts öffnend right opening apertura a la derecha
 Arbeitslänge 90 mm Working length 90 mm Largo util de 90 mm	70° gebogen curved curvo	47325-01	47325-02	47325-03
 Arbeitslänge 105 mm Working length 105 mm Largo util de 105 mm	gerade straight recto	47326-01	47326-02	47326-03
 Arbeitslänge 105 mm Working length 105 mm Largo util de 105 mm	70° gebogen curved curvo	47327-01	47327-02	47327-03



Nasenzangen, Rohrschaft, einfachbeweglich
 Nasal Forceps, Tube Shaft, single action jaws
 Pinzas nasales, vastago tubular, simple accion

BLAKESLEY Nasenzange, Arbeitslänge 130 mm
 BLAKESLEY nasal forceps, working length 130 mm
 Pinza nasal BLAKESLEY, largo util de 130 mm

Maul gefenstert und gerade
 Jaw fenestrated, straight
 Boca fenestrada y recta

Schnitt / Cut / corte	3,0 mm	3,5 mm	4,0 mm
	47223-30	47223-35	47223-40
	47226-30	47226-35	47226-40







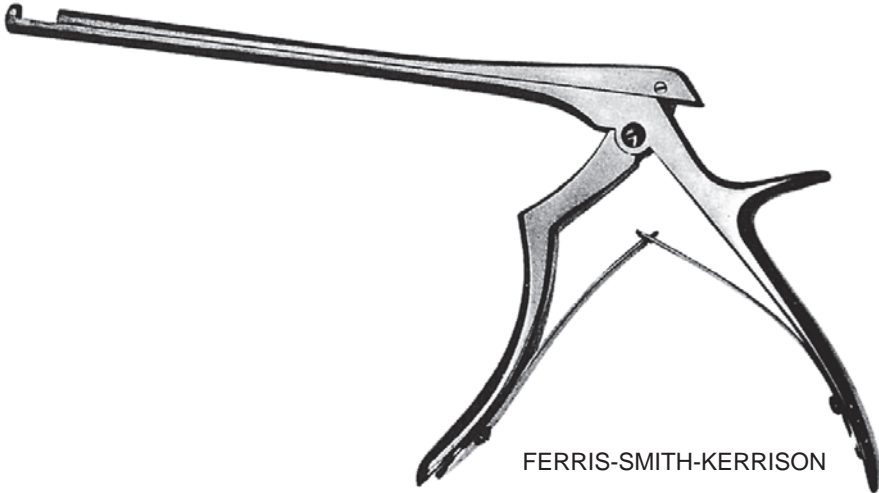



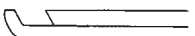
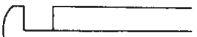

Maul gefenstert und 45° nach oben abgewinkelt
 Jaw fenestrated and 45° angled upwards
 Boca fenestrada y angulada hacia arriba en 45°

Schnitt / Cut / corte	3,0 mm	3,5 mm	4,0 mm
	47224-30	47224-35	47224-40
	47227-30	47227-35	47227-40

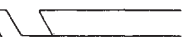
Knochenstanzen
Bone Punch
Pinzas para huesos

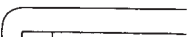

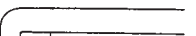
FERRIS-SMITH-KERRISON

	90°	90°	40°
18 cm, 7"	 41510-01 1 mm	 41511-01 1 mm	 41512-01 1 mm
18 cm, 7"	 41510-02 2 mm	 41511-02 2 mm	 41512-02 2 mm
18 cm, 7"	 41510-03 3 mm	 41511-03 3 mm	 41512-03 3 mm
18 cm, 7"	 41510-04 4 mm	 41511-04 4 mm	 41512-04 4 mm
18 cm, 7"	 41510-05 5 mm	 41511-05 5 mm	 41512-05 5 mm

auch lieferbar mit Dünnpfuß
also available with thin foot plate
tambien disponible con lámina de punzonar estrecha

Stanzen
Punches
Pinzas



KERRISON
17 cm, 6 3/4"

- 3x3 mm 47303-03
- 4x4 mm 47303-04
- 5x5 mm 47303-05
- 6x6 mm 47303-06

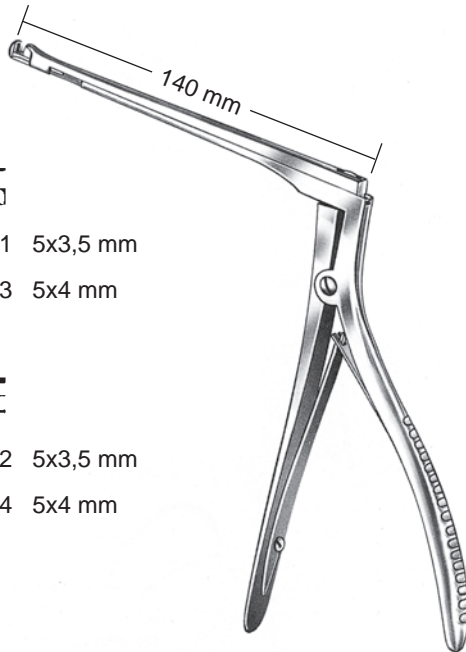

∩ 47304-01 5x3,5 mm

∩ 47304-03 5x4 mm



U 47304-02 5x3,5 mm

U 47304-04 5x4 mm

HAJEK-KOFLER

Stanze
Punch
Pinza



HAJEK-KOFLER
47316-16
3,5 mm

Antrumstanzen
Antrum Punches
Pinzas para antro

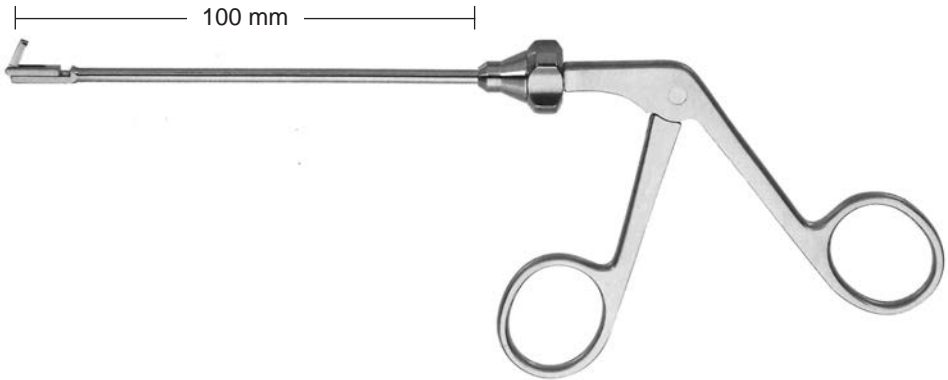

Retro Stanzen
Retro Punches
Pinza retrograda



Ø 4,5 mm

starr, Schnitt 2,5 x 6,5 mm
rigid, cut 2.5 x 6.5 mm
rigida, corte 2,5 x 6,5 mm

- 47310-00 rechts schneidend / right cutting / corte hacia la derecha
- 47311-00 links schneidend / left cutting / corte hacia la izquierda
- 47312-00 nach oben schneidend / upward cutting / corte hacia arriba
- 47313-00 nach unten schneidend / downward cutting / corte hacia abajo



Ø 3,0 mm

starr, Schnitt 2,0 x 5,0 mm
rigid, cut 2.0 x 5.0 mm
rigida, corte 2,0 x 5,0 mm

- 47316-00 rechts schneidend / right cutting / corte hacia la derecha
- 47317-00 links schneidend / left cutting / corte hacia la izquierda
- 47315-00 nach oben schneidend / upward cutting / corte hacia arriba
- 47314-00 nach unten schneidend / downward cutting / corte hacia abajo



Ø 3,0 mm

Schnitt 2,0 x 5,0 mm
Cut 2.0 x 5.0 mm
corte 2,0 x 5,0 mm

- 47318-00 **360° drehbar / rotatable / giratoria**

Antrumstanzen
Antrum Punches
Pinzas para antro

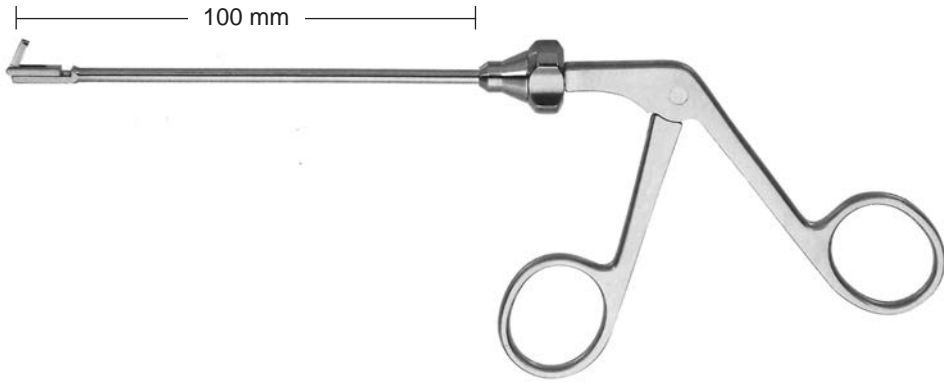

Retro Stanzen, für Kinder
Retro punches, for children
Pinza retrograda, para niños



Ø 3,0 mm

starr, Schnitt 1,5 x 3,5 mm
rigid, cut 1.5 x 3.5 mm
rigida, corte 1,5 x 3,5 mm

- 47321-00 rechts schneidend / right cutting / corte hacia la derecha
- 47322-00 links schneidend / left cutting / corte hacia la izquierda
- 47323-00 nach oben schneidend / upward cutting / corte hacia arriba
- 47324-00 nach unten schneidend / downward cutting / corte hacia abajo



Ø 3,0 mm

Schnitt 1,5 x 3,5 mm
Cut 1.5 x 3.5 mm
corte 1,5 x 3,5 mm

- 47325-00 **360° drehbar / rotatable / giratoria**

Zirkular Stanze
Circular Punch
Pinza circular

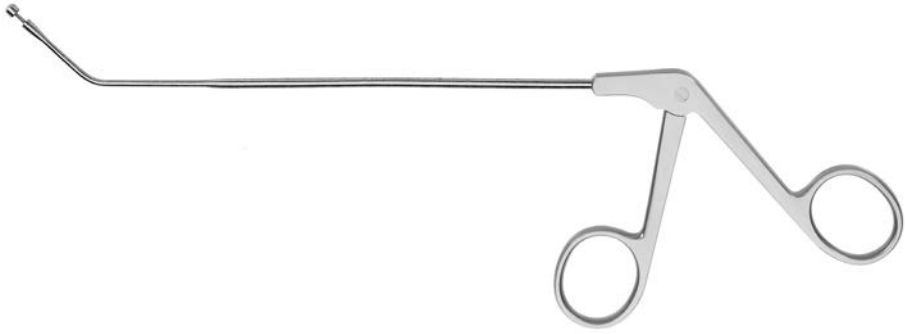

360° schneidend / cutting / cortante

gerader Schaft
shaft straight
vástago recto

45° nach oben gebogen
45° curved upward
curvada hacia arriba en 45°

Ø 3,5 mm 47319-35
Ø 4,5 mm 47319-45

47320-35
47320-45

Nasenscheren
Nasal Scissors
Tijeras nasales

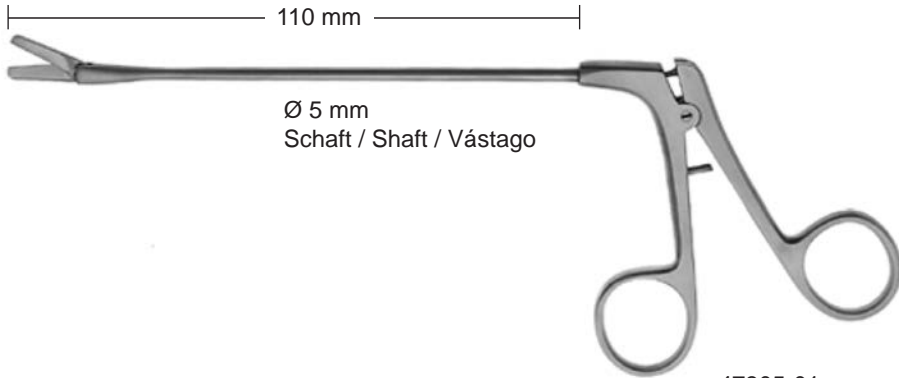

47305-01
gerade
straight
recta



47305-02
rechts gebogen
right curved
curvada hacia la derecha



47305-03
links gebogen
left curved
curvada hacia la izquierda

Präparierscheren
Dissecting Scissors
Tijeras de disección



METZENBAUM



09280-12	12 cm, 4 $\frac{3}{4}$ "	09281-12
09284-12 TC	12 cm, 4 $\frac{3}{4}$"	09285-12 TC
09966-11 SC	12 cm, 4 $\frac{3}{4}$"	09967-11 SC
09280-15	15 cm, 6"	09281-15
09284-15 TC	15 cm, 6"	09285-15 TC
09970-14 SC	15 cm, 6"	09971-14 SC
09280-18	18 cm, 7"	09281-18
09284-18 TC	18 cm, 7"	09285-18 TC
09970-18 SC	18 cm, 7"	09971-18 SC

Präparierscheren
Dissecting Scissors
Tijeras de disección



METZENBAUM



09270-15
09270-18

15 cm, 6"
18 cm, 7"



09271-15
09271-18

09274-15 TC
09274-18 TC

15 cm, 6"
18 cm, 7"

09275-15 TC
09275-18 TC



METZENBAUM-FINO



09282-15
09286-15 TC

15 cm, 6"
15 cm, 6"



09283-15
09287-15 TC

09282-18
09286-18 TC

18 cm, 7"
18 cm, 7"

09283-18
09287-18 TC

Präparierscheren
Dissecting Scissors
Tijeras de disección



SANVENERO



09302-14

14 cm, 5 1/2"



09303-14



JOSEPH



09304-14

14 cm, 5 1/2"



09305-14

Präparierscheren
Dissecting Scissors
Tijeras de disección



KILNER (RAGNELL)

09310-12	12 cm, 4 ¾"
09314-12 TC	12 cm, 4 ¾"
09995-12 SC	12 cm, 4 ¾"
09310-15	15 cm, 6"



REYNOLDS (JAMESON)
09321-15 15 cm, 6"
09993-15 SC 15 cm, 6"
09321-18 18 cm, 7"

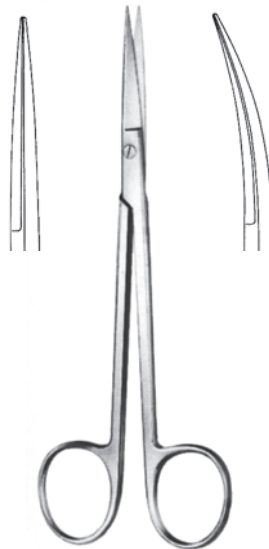

KELLY
09540-16 16 cm, 6 ¼" 09541-16
09542-16 TC 16 cm, 6 ¼" **09543-16 TC**
09544-16 SC 16 cm, 6 ¼" **09545-16 SC**

Feine Scheren
Delicate Scissors
Tijeras finas

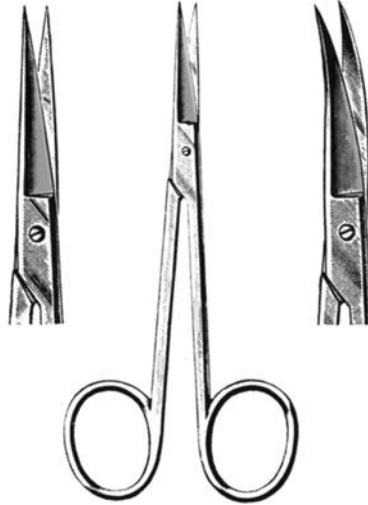

IRIS

09340-09	9 cm, 3 1/2"	09341-09
09340-10	10 cm, 4"	09341-10
09340-11	11 cm, 4 3/8"	09341-11
09344-11 TC	11 cm, 4 3/8"	09345-11 TC
09980-11 SC	11 cm, 4 3/8"	09981-11 SC



BONN

09342-08 8 cm, 3 1/8" 09343-08

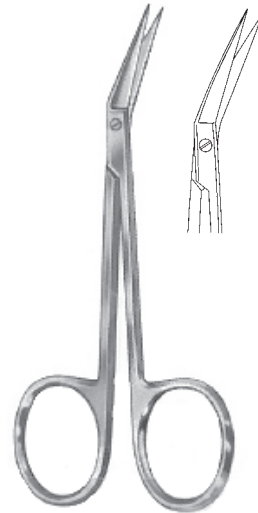

IRIS

09346-11
11 cm, 4 3/8"

Feine Scheren
Delicate Scissors
Tijeras finas



KNAPP
10 cm, 4"



09348-01



09348-02



09348-03



09348-04



09348-05



09348-06

Feine Scheren
Delicate Scissors
Tijeras finas



LITTLER
09349-12
12 cm, 4 ³/₄"



GRAEFE
09350-10
10 cm, 4"



CONVERSE/WILMER/WALTER
09352-10
10 cm, 4"



COTTLE
09358-11
11 cm, 4 ³/₈"

Feine Scheren
Delicate Scissors
Tijeras finas

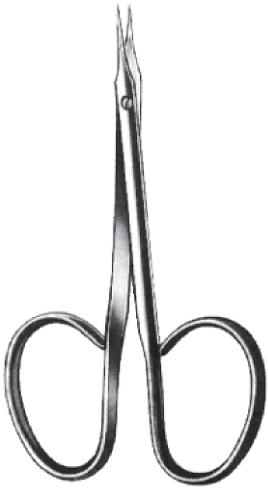

GRADLE
09350-09 9,5 cm, 3 3/4" 09351-09



09352-09 9,5 cm, 3 3/4" 09353-09



09354-10 10 cm, 4" 09355-10



09356-10 10 cm, 4" 09357-10

Feine Scheren
Delicate Scissors
Tijeras finas

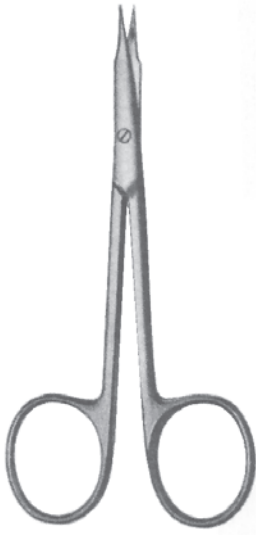

STEVENS
11 cm, 4 $\frac{3}{8}$ "

spitz
sharp
aguda



09360-11
09984-11SC



09361-11
09985-11 SC

stumpf
blunt
roma



09362-11



09363-11



STRABISMUS
09370-11 11 cm, 4 $\frac{3}{8}$ " 09371-11
09374-11TC 11 cm, 4 $\frac{3}{8}$ " 09375-11TC

Feine Scheren
Delicate Scissors
Tijeras finas



WAGNER
12 cm, 4 3/4"



09828-12



09826-12



09824-12
09982-12SC



WAGNER
12 cm, 4 3/4"



09823-12

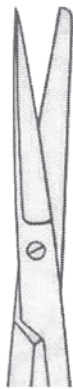

09829-12



09825-12
09983-12 SC

Nasenscheren
Nasal Scissors
Tijeras nasales



HEYMAN
09401-18 18 cm, 7"



FOMON
09403-15 15 cm, 6"



COTTLE
09405-16 16 cm, 6 1/4"
09405-16TC 16 cm, 6 1/4"

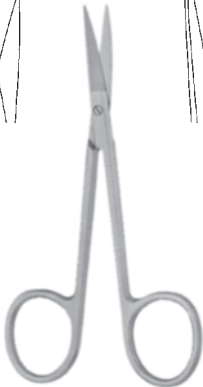

COTTLE-MASING
09406-10 10 cm, 4" 09407-10



FOMON
09617-13 13 cm, 5 1/8"

Fadenscheren
Stitch Scissors
Tijeras para hilos



SPENCER
09802-09 9 cm, 3 1/2"
09802-11 11 cm, 4 3/8"



LITTAUER
09804-14
14 cm, 5 1/2"



O`BRIEN
09805-09
9 cm, 3 1/2"

Face Lift Scheren
 Face Lift Scissors
 Face Lift tijeras

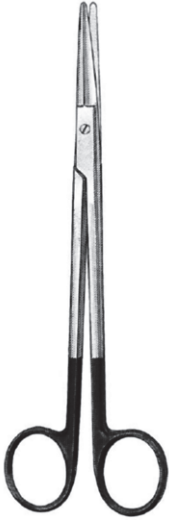

GORNEY
 19 cm, 7 1/2"

10010-19

10012-19 TC

10014-19 SC

10011-19

10013-19 TC

10015-19 SC



GORNEY-FREEMAN

10061-19 19 cm, 7 1/2"

10061-19 TC 19 cm, 7 1/2"

10061-19 SC 19 cm, 7 1/2"

10061-23 23 cm, 9"

10061-23 TC 23 cm, 9"

10061-23 SC 23 cm, 9"

Face Lift Scheren
 Face Lift Scissors
 Face Lift tijeras



KAYE

10028-14 TC	14 cm, 5 1/2"	10029-14 TC
10034-14 SC	14 cm, 5 1/2"	10035-14 SC
10030-18 TC	18 cm, 7"	10031-18 TC
10036-18 SC	18 cm, 7"	10037-18 SC
10032-23 TC	23 cm, 9"	10033-23 TC
10038-23 SC	23 cm, 9"	10039-23 SC



PECK-JOSEPH

10044-14	14,5 cm, 5 3/4"	10045-14
10048-14 SC	14,5 cm, 5 3/4"	10049-14 SC



BEUSE

10050-14	14 cm, 5 1/2"	10051-14
10050-18	18 cm, 7"	10051-18

Blepharoplastik Scheren
Blepharoplasty Scissors
Tijeras para blefaroplastia



GREENBERG-PAR
10201-11 11,5 cm, 4 ½"
10201-11SC 11,5 cm, 4 ½"



KAYE
10206-11 11,5 cm, 4 ½" 10207-11
10206-11SC 11,5 cm, 4 ½" **10207-11SC**

Mikro Scheren
Micro Scissors
Micro tijeras



11 cm, 4 $\frac{3}{8}$ "	10202-11	10203-11
14,5 cm, 5 $\frac{3}{4}$ "	10202-14 10202-14T	10203-14 10203-14T
18 cm, 7"	10202-18 10202-18T	10203-18 10203-18T

T= Titan, titanium, titanio

Mikro Scheren
Micro Scissors
Micro tijeras

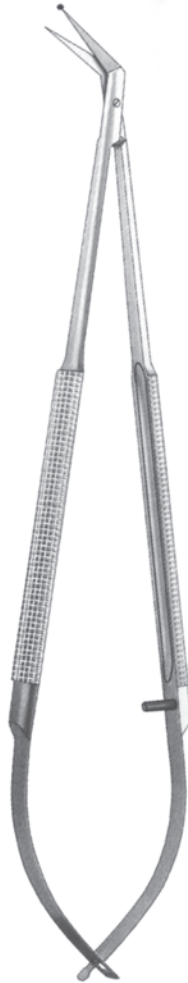

18 cm, 7"



25°

10220-25

10220-25T



45°

10220-45

10220-45T

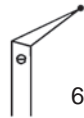

60°

10220-60

10220-60T

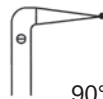

90°

10220-90

10220-90T

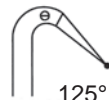

125°

10220-00



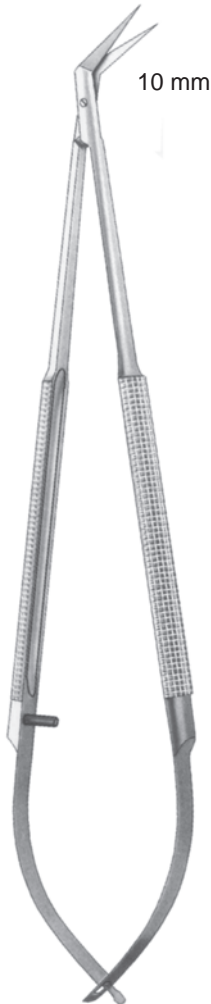

10220-00T

T= Titan, titanium, titanio

Mikro Scheren
Micro Scissors
Micro tijeras



10 mm

	11 cm 4 3/8"	14,5 cm 5 3/4"	18 cm 7"
 25°	10226-11	10226-14	10226-18 10226-18T
 45°	10227-11	10227-14	10227-18 10227-18T
 60°	10228-11	10228-14	10228-18 10228-18T
 90°	10229-11	10229-14	10229-18 10229-18T
 125°	10230-11	10230-14	10230-18 10230-18T

T= Titan, titanium, titanio

Nasenschere
Nasal Scissor
Tijera nasal



CAPLAN
47256-20
20 cm, 8"

Tumorschere
Tumor Scissors
Tijera para tumores

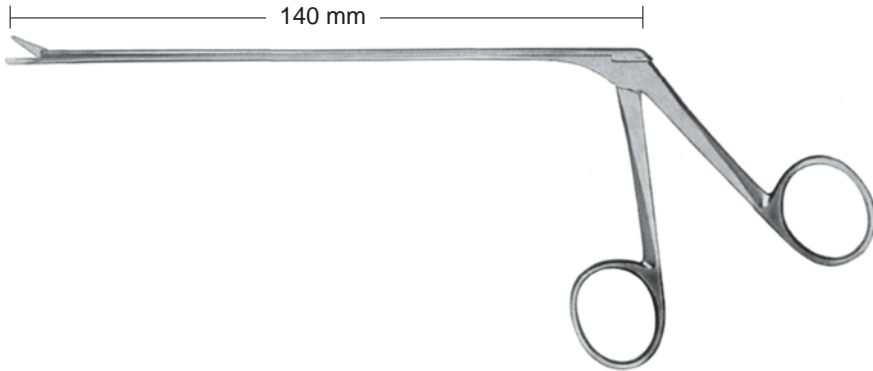

93755-14

gerade
straight
recta



93756-14

rechts gebogen
curved right
curvada hacia la derecha



93757-14

links gebogen
curved left
curvada hacia la izquierda

Knochensplitterzangen
Bone Cutting Forceps
Pinzas cortantes para huesos



COTTLE-KAZANJIAN
33282-19
19 cm, 7 ½"



MC INDOE
33283-17
17 cm, 6 ¾"

Nadelhalter
Needle Holders
Porta-agujas



DERF
25110-12 12 cm, 4 3/4" **25114-12 TC**



WEBSTER
25128-13 13 cm, 5 1/8"
25129-13 TC 13 cm, 5 1/8"

BABY-WEBSTER
25136-11 11 cm, 4 3/8"
25137-11 TC 11 cm, 4 3/8"



HALSEY
25130-13 13 cm, 5 1/8" 25140-13
25134-13 TC 13 cm, 5 1/8" 25144-13 TC



CRILE-WOOD
25160-15 15 cm, 6" **25164-15 TC**

Saug- und Spülinstrumente
Suction and Irrigation Instruments
Instrumentos de aspiración y irrigación

Luer-Lock

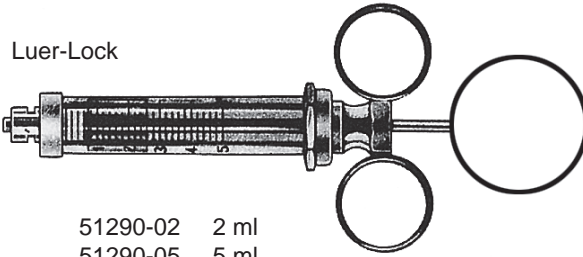

- 51290-02 2 ml
- 51290-05 5 ml
- 51290-10 10 ml
- 51290-20 20 ml



51291-00
2,5 mm Ø

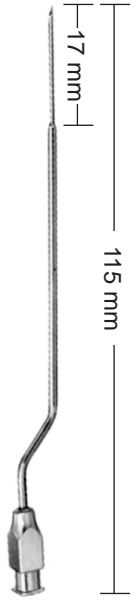

51293-00
0,8 mm Ø



51292-00



51293-45
45°



51293-90
90°

Saugrohre
Suction Tubes
Tubos de aspiración

Koagulations-Saugrohr, gerade
Coagulation Suction Tube, straight
Tubo de succión y coagulación, recto



41312-10
Nutzlänge 10 cm, 4"
Working length 10 cm, 4"
Largo útil 10 cm, 4"

41312-26
Nutzlänge 26 cm, 10 ¼"
Working length 26 cm, 10 ¼"
Largo útil 26 cm, 10 ¼"

Kabelanschluß männlich
Cable connector male
Conexion del cable macho

Spülkanülen
Irrigating Tubes
Canulas irrigadoras



EICKEN (KILLIAN)
14,5 cm, 5 3/4"
Ø

47331-20	2,0 mm	47332-20
47331-25	2,5 mm	47332-25
47331-30	3,0 mm	47332-30
47331-40	4,0 mm	47332-40

KILLIAN
Ø 1,5 mm
47345-15

Saugkanülen
Suction Tubes
Cánulas aspiradoras

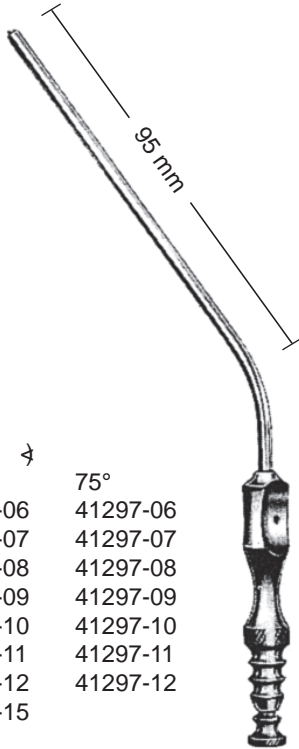

Charr.	F.G.	30°	75°
6	41295-06		41297-06
7	41295-07		41297-07
8	41295-08		41297-08
9	41295-09		41297-09
10	41295-10		41297-10
11	41295-11		41297-11
12	41295-12		41297-12
15	41295-15		

FRAZIER/FERGUSSON
19 cm, 7 ½"

FERGUSSON
41294-40
18 cm, 7"
ø 4 mm, 90°

Saugrohre
Suction Tubes
Tubos de aspiración

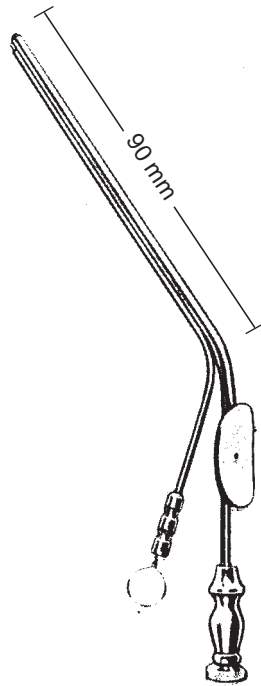

HOUSE
9 cm, 3 ½"

41303-09	Ø 0,9 x 0,7 mm
41303-12	Ø 1,2 x 0,9 mm
41303-15	Ø 1,5 x 1,2 mm
41303-18	Ø 1,8 x 1,8 mm
41303-25	Ø 2,5 x 2,0 mm
41303-30	Ø 3,0 x 2,0 mm
41303-45	Ø 4,5 x 2,0 mm

Trokare
Trocars
Trócares

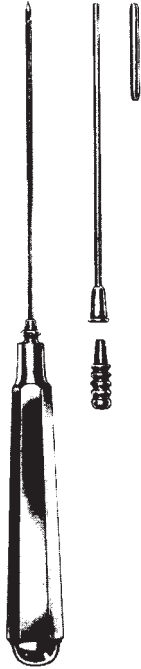

LICHTWITZ
23128-19 1,75 mm Ø

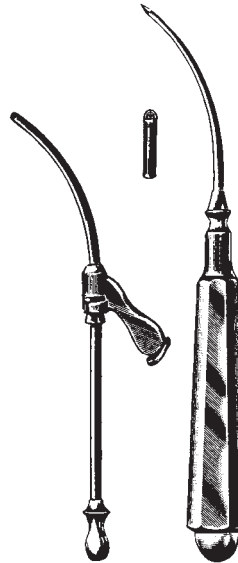

COAKLEY
23140-02 2,25 mm Ø

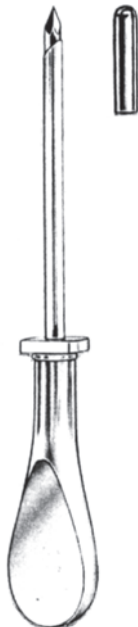

SINOSKOPIE TROKAR
Universal
8,5 cm, 3.4"

23181-40 für Optik mit Ø 4,0 mm
for optics Ø 4,0 mm
para la óptica de Ø 4,0 mm

Nasenmesser
Nasal Knives
Bisturies nasales



JOSEPH
16 cm, 6 ¼"



47370-16 47371-16
stumpf, blunt,
romos



47372-16 47373-16
spitz, pointed,
agudos



FREER
47374-16
16,5 cm, 6 ½"



JOSEPH
47375-16
16,5 cm, 6 ½"



FREER
47375-19
19 cm, 7 ½"

Nasenplastik- und Operationsmesser, Sichelmesser
 Rhinoplastic and Nasal Knives, Septum Sickle Knives
 Bisturries para plastica y operaciones de la nariz, Bisturries para el tabique nasal

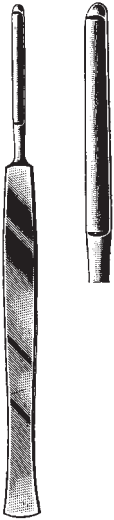

JOSEPH
 47376-16
 16 cm, 6 1/4"

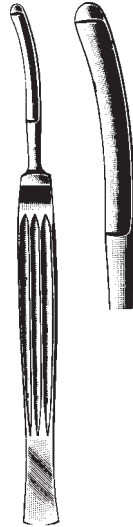

CONVERSE
 47379-16
 16 cm, 6 1/4"



COTTLE
 47380-15
 15 cm, 6"



COTTLE
 47382-15
 15 cm, 6"



JOSEPH
 47384-15
 15 cm, 6"



JOSEPH
 47385-15
 15 cm, 6"



REDA
 19 cm, 7 1/2"



47386-01
 spitz
 pointed
 agudo



47386-02
 stumpf
 blunt
 romo

Schwingmesser
Septum Swivel Knives
Bisturios para el tabique nasal



BALLENGER
20 cm, 8"



47390-03
3 mm



47390-04
4 mm



47390-05
5 mm



47392-03
3 mm



47392-04
4 mm



47392-05
5 mm

Submukosamesser, Knorpelritzmesser
Submucosa Knife, Cartilage Knife
Cuchillo para submucosa, Cuchillo para rajar cartilagos



FREER-INGALS
47372-17
17 cm, 6 ¾"



MASING
47377-13
13 cm, 5 1/8"

Dermatome
Dermatome
Dermàtomos



SCHINK
07490-00
30 cm, 11 3/4"

compl.
mit/with/con
07490-01 (1) Stk./pcs
07490-02 (2) Stk./pcs



07490-01

Ersatzklinge
Spare blade
Hoja de repuesto

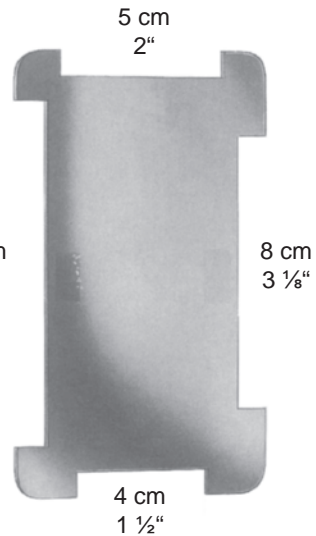

07490-02

Spannplatte
Skin straightening plate
Placa para extender la piel

Dermatome
Dermatome
Dermátomos



HUMBY
07495-31
31 cm, 12 ¼"



SILVER
07498-00
19 cm, 7 ½"



WATSON
07499-00
30 cm, 11 ¾"

Ersatzklingen, unsteril / Spare blade, non sterile
Hoja de repuesto, no esteril

07496-31

07296-00

07499-01

Septum Elevatoren
Septum Elevators
Elevadores para el tabique



McKENTY
15 cm, 6"



47410-04
4 mm



47410-05
5 mm



HALLE
47410-16
16,5 cm, 6 1/2"



JOSEPH
47411-16
16 cm, 6 1/4"



ROGER
47413-19
19 cm, 7 1/2"



MASING
47414-21
21 cm, 8"



5 mm



5 mm

Septum Elevatoren
Septum Elevators
Elevadores para el tabique

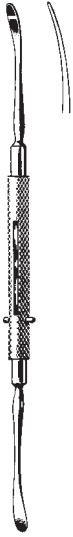

FREER
47415-18
18 cm, 7"



FREER
47417-19
19 cm, 7 1/2"

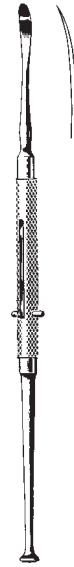

FREER
47419-19
19 cm, 7 1/2"



KILLIAN
47420-01
18,5 cm, 7 1/4"



PIERCE
47420-02
21 cm, 8 1/4"



SINUS
47420-03
18 cm, 7"

Septum Elevatoren
Septum Elevators
Elevadores para el tabique



PENNINGTON
47420-04
21 cm, 8 1/4"



McKENTY
47420-20
22 cm, 8 3/4"



HOWARTH
47421-21
21,5 cm, 8 1/2"



COTTLE
47421-23
23 cm, 9"



COTTLE JOSEPH
47422-22
22 cm, 8 3/4"



COTTLE
47423-22
22 cm, 8 3/4"

Septum Elevatoren
Septum Elevators
Elevadores para el tabique

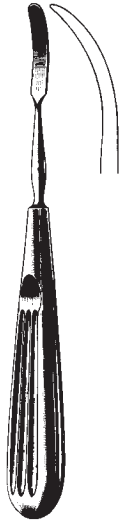

COTTLE
47424-16
16 cm, 6 ¼"



COTTLE
47425-19
19 cm, 7 ½"



KILLIAN
47426-22
22 cm, 8 ¾"



HAJEK-BALLENGER
47428-21
22 cm, 8 ¾"



BALLENGER
47430-22
22 cm, 8 ¾"

Elevatoren
Elevators
Elevadores

Nasenfraktur-Elevator
Nasal fracture elevator
Elevador para fracturas nasales

Septumfraktur-Elevator
Septum fracture elevator
Elevador para fracturas del tabique nasal

9 mm

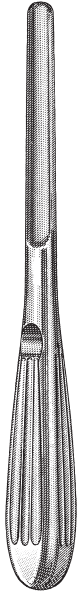

BOIES
33720-19
19 cm, 7 ½"

6 mm



GOLDMANN
33720-20
20 cm, 8"



Antrum-Elevator
Antrum Elevator
Elevador para el antro

SEWALL
47412-20
20 cm, 8"

Raspatorien
Raspatories
Periostótomos

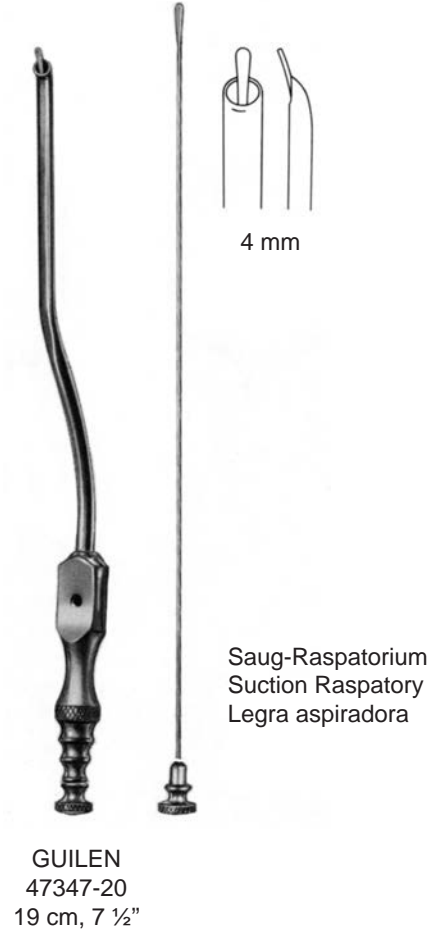
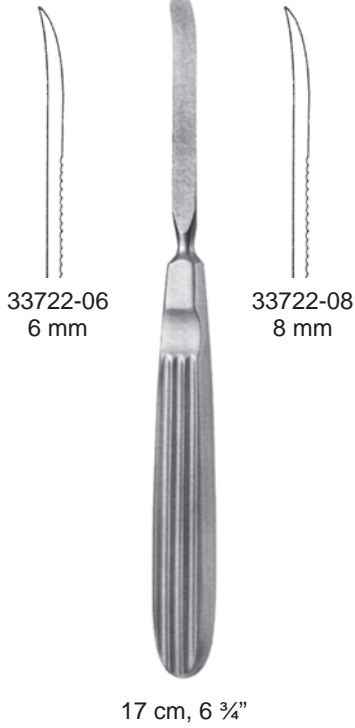

Osteotom mit Ferrozellgriff
Osteotome with Ferrozell-Handle
Osteótomo con mango de Ferrozell

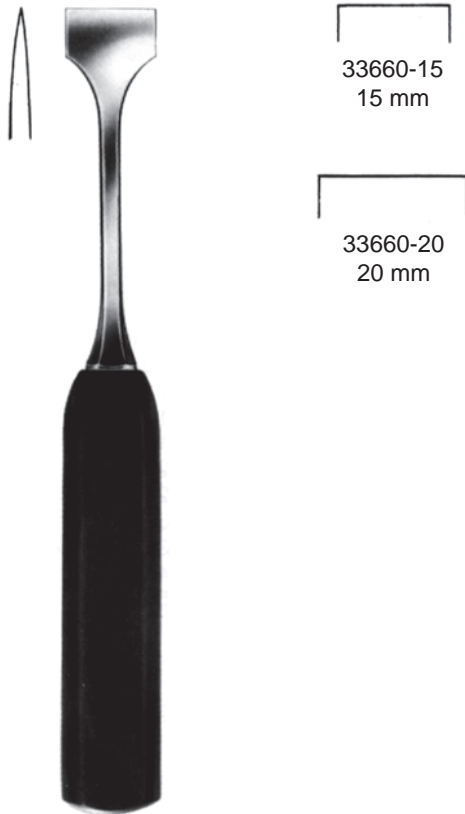

LEXER
22 cm, 8 3/4"

Osteotome
 Osteotomes
 Osteotomo

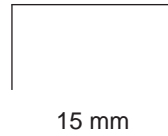
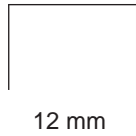

MINI-LAMBOTTE

12,5 cm, 5"	mm	17 cm, 6 ¾"
33654-02	2	33652-02
33654-03	3	33652-03
33654-04	4	33652-04
33654-06	6	33652-06
33654-08	8	33652-08
33654-10	10	33652-10
33654-12	12	33652-12
33654-15	15	33652-15

Septum Meißel
Rhinoplastic Chisels
Cinceles para la plàstica nasal

4 mm



FREER
47450-04
15 cm, 6"

4 mm



FREER
47451-04
15 cm, 6"

Septum Meißel
Rhinoplastic Chisels
Cinceles para la plástica nasal



COTTLE
18 cm, 7"



47454-04
4 mm



47454-07
7 mm



47454-09
9 mm



47454-12
12 mm



COTTLE
47455-06
18 cm, 7"



6 mm



COTTLE
18 cm, 7"



47458-04
4 mm



47458-07
7 mm



47458-09
9 mm



47458-12
12 mm



COTTLE
18 cm, 7"



47460-04
4 mm



47460-07
7 mm



47460-12
12 mm

Septum Meißel
 Rhinoplastic Chisels
 Cinceles para la plàstica nasal

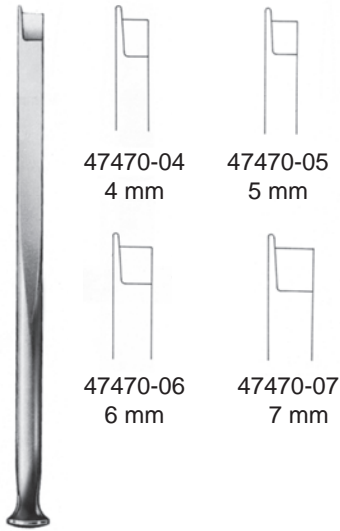

FOMON
 17 cm, 6 3/4"

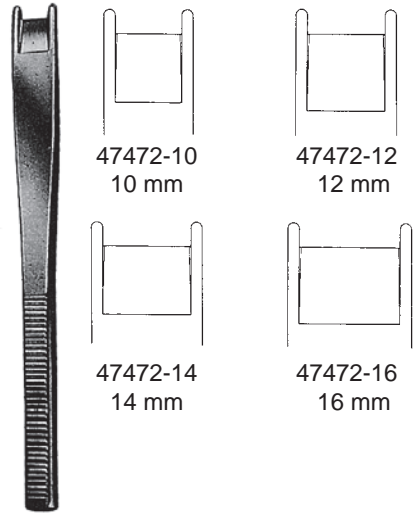

CINELLI
 16 cm, 6 1/4"

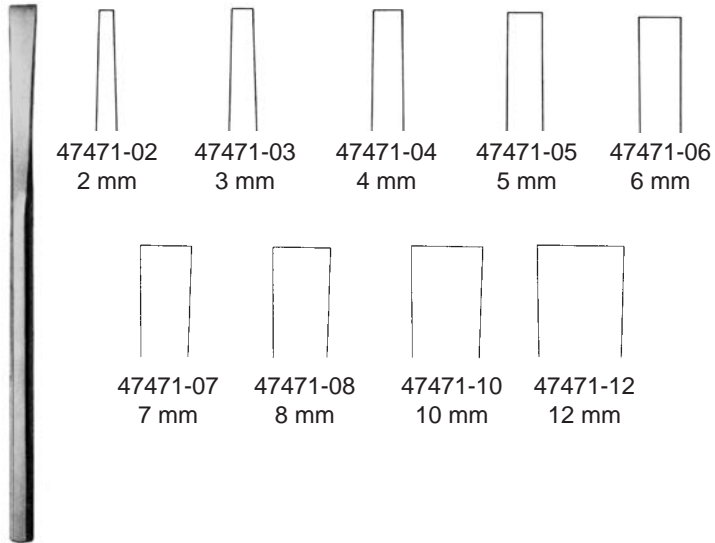

SHEEHAN
 16 cm, 6 1/4"

Septum Meißel, Osteotom
 Rhinoplastic Chisels, Osteotomes
 Cinceles para la plàstica nasal, Osteótomos

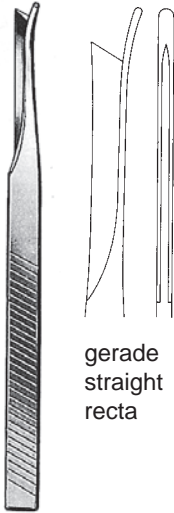

gerade
 straight
 recta

SILVER
 47473-01
 18 cm, 7"

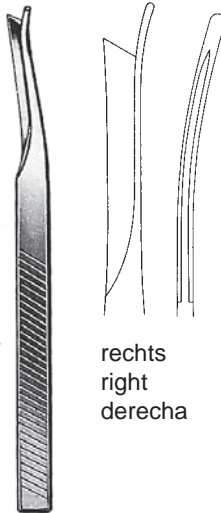

rechts
 right
 derecha

SILVER
 47473-02
 18 cm, 7"

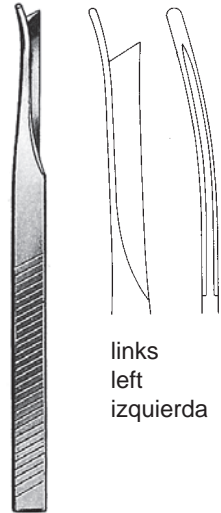

links
 left
 izquierda

SILVER
 47473-03
 18 cm, 7"

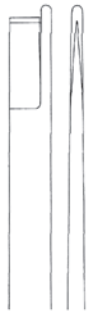

47474-03

gerade
 straight
 recta



47474-01

rechts
 right
 derecha



47474-02

links
 left
 izquierda

NEIVERT-ANDERSON
 20,5 cm, 8" 7 mm

Osteotome
Osteotomes
Osteotomos

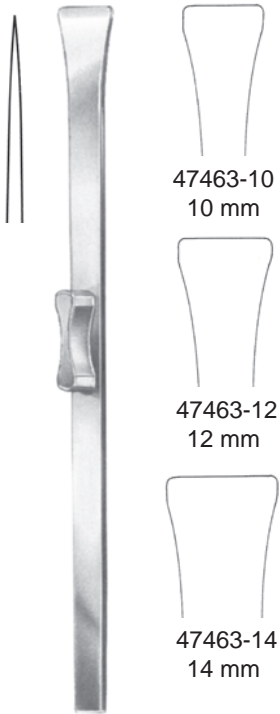

RUBIN
18,5 cm, 7 ¼"



47475-04 4 mm
47475-06 6 mm
47475-08 8 mm

OBWEGESER
18,5 cm, 7 ¼"

Meißel
Chisels
Cinceles

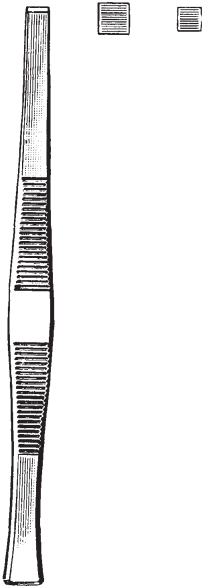

PASSOW
12 cm, 4 3/4"
33626-35 3,5 mm
33626-25 2,5 mm



47457-03
3,0 mm

47457-05
4,5 mm



WALTER
18 cm, 7"

Septum Meißel
 Rhinoplastic Chisels
 Cinceles para la plàstica nasal



KILLIAN-CLAUS
 47482-05
 17 cm, 6 3/4"



HAJEK
 16 cm, 6 1/4"

- 47484-04 4 mm
- 47484-06 6 mm
- 47484-08 8 mm



WEST
 47486-16
 16 cm, 6 1/4"

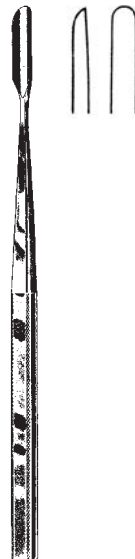

WEST
 47487-16
 16 cm, 6 1/4"

6 mm



FREER
 47489-16
 16 cm, 6 1/4"

Knorpelquetscher
Cartilage Crusher
Machacadora de cartilago



COTTLE
47461-00 7,5 cm, 3"

Nasenraspeln
 Nasal Rasps
 Escofinas nasales



JOSEPH
 47502-16 16 cm, 6 1/4"



MALTZ
 47504-18 18 cm, 7"

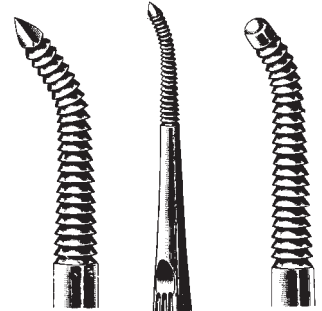

47507-17

47507-18

WIENER
 18 cm, 7"



diamantiert
 with diamond coating
 con boca de diamante

PEET
 47523-01 19 cm 7 1/2" 47523-02



GLABELLA
 47524-01 21 cm, 8 1/4"

47525-20
 fein, 20 Zähne
 fine, 20 teeth
 fina, 20 dientes

47526-20
 grob, 11 Zähne
 coarse, 11 teeth
 gruesa, 11 dientes



PARKES
 21 cm, 8 1/4"

Nasenraspeln
Nasal Rasps
Escofinas nasales

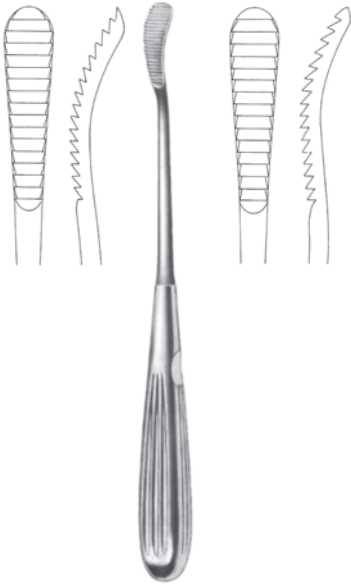

AUFRICHT
47511-21 21 cm, 8 ¼" 47513-21

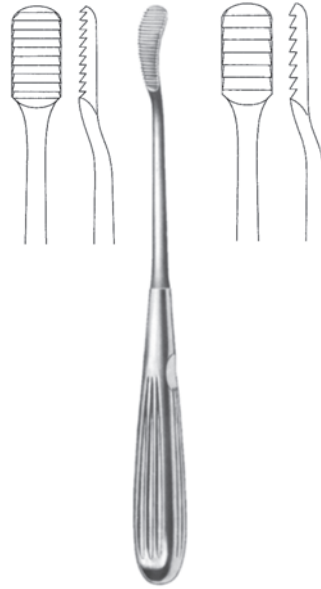

JOSEPH (LEWIS)
47514-16 18 cm, 7" 47516-16

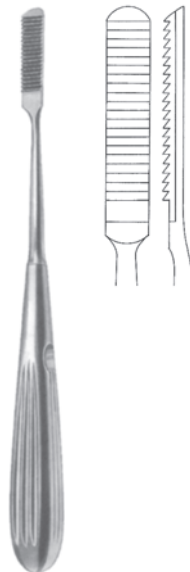

MALTZ (COTTLE)
47518-21 21 cm, 8 ¼"

Nasenraspel
Nasal Rasp
Escofina nasal

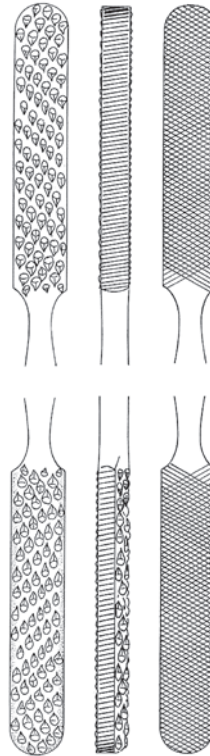

FOMON
47520-21
21 cm, 8 1/4"

Nasenraspeln
Nasal Rasps
Escofinas nasales

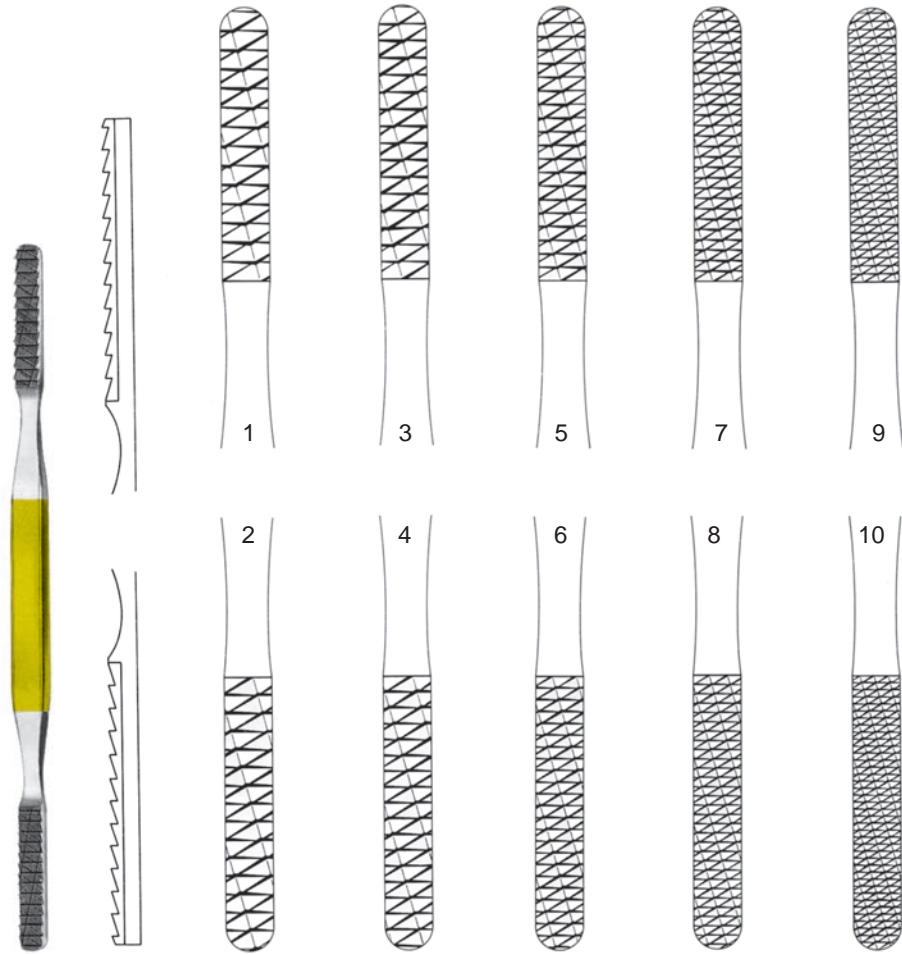

FOMON
20 cm, 8"

Fig. 1/2
47522-01 TC

Fig. 3/4
47522-04 TC

Fig. 5/6
47522-05 TC

Fig. 7/8
47522-07 TC

Fig. 9/10
47522-09 TC

Nasenraspeln
Nasal Rasps
Escofinas nasales



MASING
47528-01
21 cm, 8 1/4"



MASING
47528-02
21 cm, 8 1/4"

Nasenraspeln
Nasal Rasps
Escofinas nasales



Fig. 1
47526-16

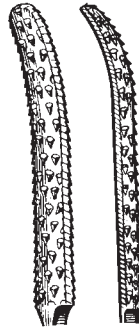

Fig. 2
47527-16

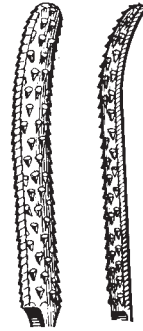
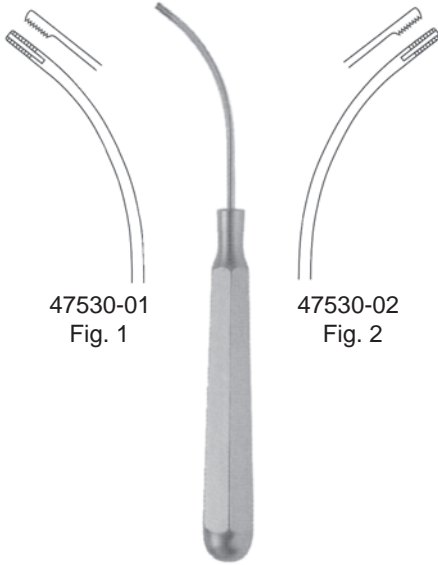

Fig. 3
47529-16



GALLAHER
16 cm, 6 1/4"

Nasenraspeln, Nasensägen
 Nasal Rasps, Nasal Saws
 Escofinas nasales, Sierras nasales



47530-01
Fig. 1

47530-02
Fig. 2

DINGMAN Set
 47530-00
 15 cm, 6"

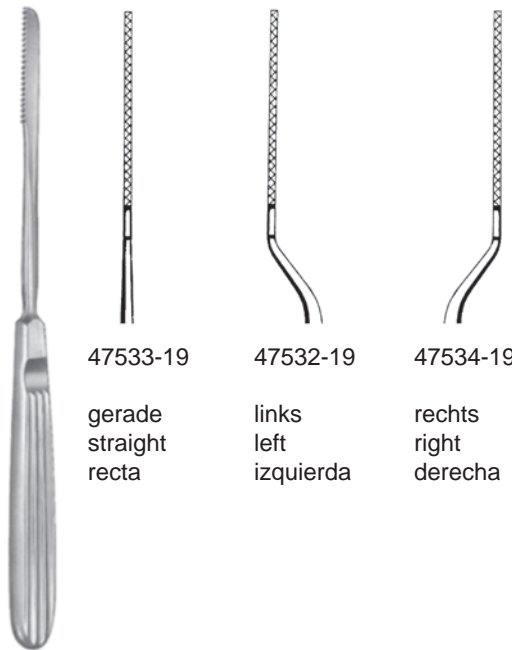

47533-19
 gerade
 straight
 recta

47532-19
 links
 left
 izquierda

47534-19
 rechts
 right
 derecha

JOSEPH
 19 cm, 7 1/2"

Nasensägen
Nasal Saws
Sierras nasales



JOSEPH
47535-01 17 cm, 6 3/4" 47535-02



LINDEMANN
47535-20 20 cm, 8"

Feine Wundhäkchen
 Fine Retractors
 Ganchos finos

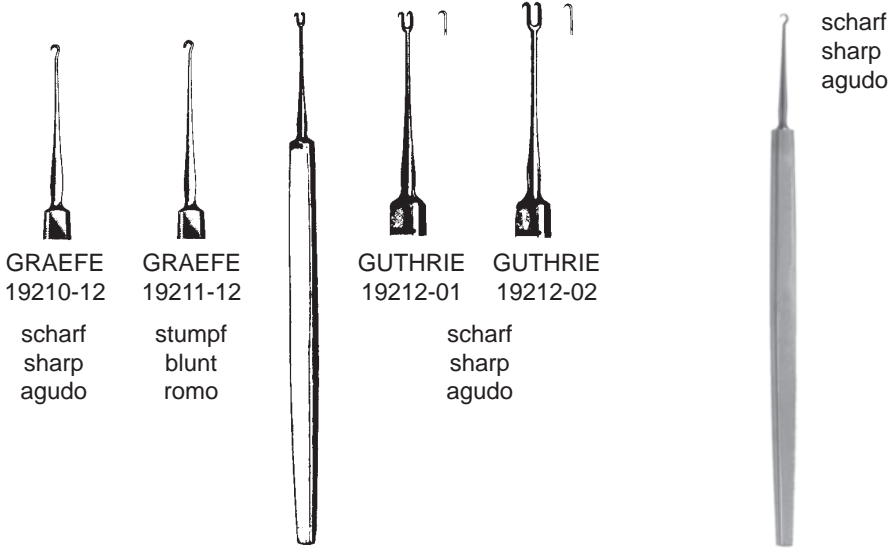

GRAEFE
19210-12

scharf
sharp
agudo

GRAEFE
19211-12

stumpf
blunt
romo

GUTHRIE
19212-01

scharf
sharp
agudo

GUTHRIE
19212-02

scharf
sharp
agudo

12 cm, 4 3/4"

TYRELL
19213-12
12 cm, 4 3/4"

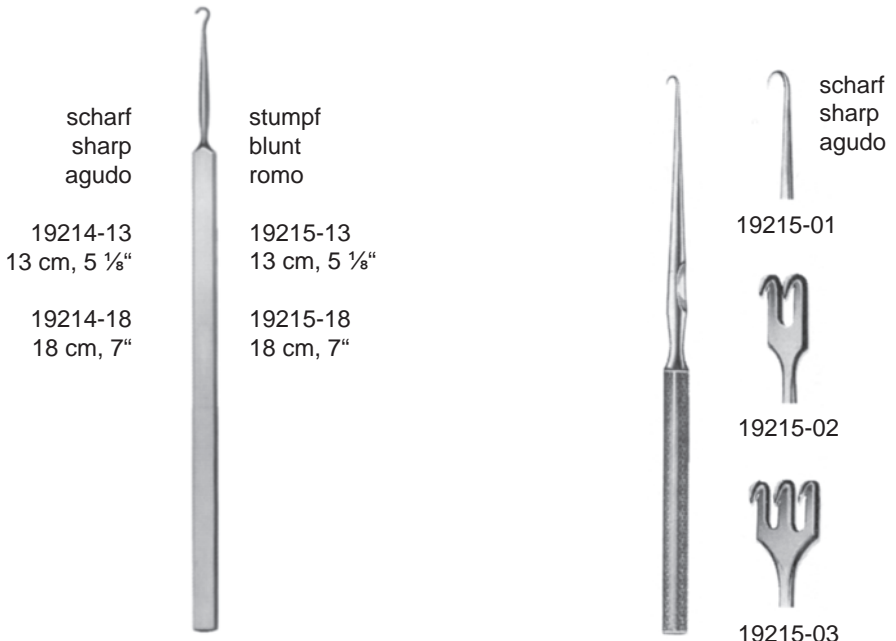

scharf
sharp
agudo

19214-13
13 cm, 5 1/8"

19214-18
18 cm, 7"

stumpf
blunt
romo

19215-13
13 cm, 5 1/8"

19215-18
18 cm, 7"

scharf
sharp
agudo

19215-01

19215-02

19215-03

FRAZIER

LAHEY
12 cm, 4 3/4"

Feine Wundhäkchen
Fine Retractors
Ganchos finos

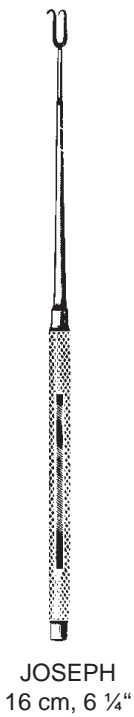

Feine Wundhäkchen
Fine Retractors
Ganchos finos

3 mm



BARSKY
19218-01
15 cm, 6"

3 mm



BARSKY
19218-02
15 cm, 6"

3 mm



HUMBY
19218-11
11,5 cm, 4 ½"

Feine Wundhäkchen
Fine Retractors
Ganchos finos

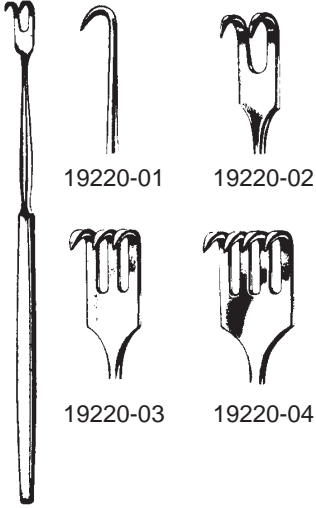

Reda
16 cm, 6 ¼"

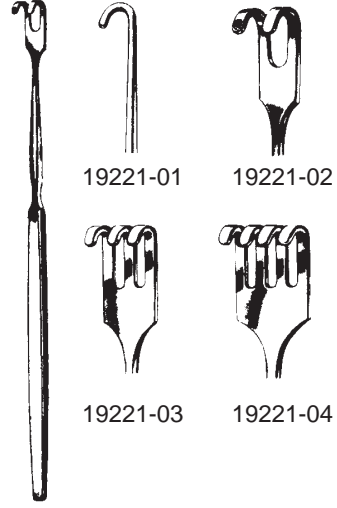

Reda
16 cm, 6 ¼"

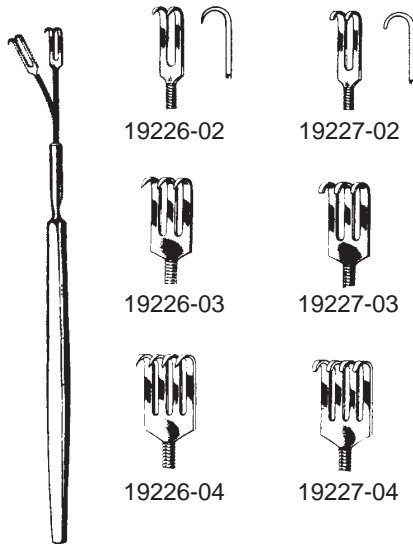

Reda, flexibel
16 cm, 6 ¼"

Feine Wundhäkchen
Fine Retractors
Ganchos finos



spitz
sharp
agudo

ROLLET
43376-13
13,5 cm, 5 1/4"



stumpf
blunt
romo

KNAPP
43377-13
13 cm, 5 1/8"



LUCAE
14 cm, 5 1/2"



45193-01
2 mm



45193-02
3 mm



45193-03
4 mm



BERGMANN
47569-14
14 cm, 5 1/2"

Nasenhaken
Nasal Retractor
Retradores nasales



COTTLE
47540-16
16 cm, 6 ¼"



MASING
47541-14
14 cm, 5 ½"



AUFRICHT
47542-12
12 cm, 4 ¾"

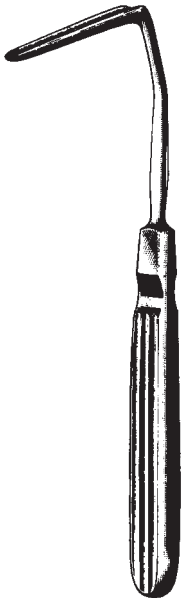

AUFRICHT
47551-16
16 cm, 6 ¼"



AUFRICHT
47551-16CL
16 cm, 6 ¼"



MASING-NEIVERT
47552-16
20 cm, 8"

Nasenflügelhäkchen
Alar Retractor
Gancho para las alas de la nariz

10 x 12 mm



COTTLE
47553-15
15 cm, 6"

10 mm



COTTLE-NEIVERT
47559-20
20 cm, 8"

10 mm



14 mm

CONVERSE
47566-12
12 cm, 4 ¾"

Nasenflügelhäkchen
Alar Retractor
Gancho para las alas de la nariz

10 mm

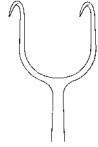

47554-01

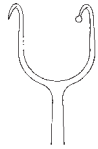

47554-02



47554-03

COTTLE
14,5 cm, 5 3/4"

3 x 11 mm

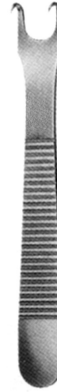

KILNER
47555-08
8 cm, 3 1/8"

10 mm



FOMON
47556-16
16 cm, 6 1/4"



FOMON
47557-17
17 cm, 6 3/4"

Feine Wundhäkchen
Fine Retractors
Ganchos finos



FREER
47558-15
15 cm, 6"



GILLIES
18 cm, 7"



Fig. 1
47560-18



Fig. 2
47562-18



COTTLE
47564-16
16 cm, 6 1/4"

Choanahaken, Fingerringhäkchen
Choana Hook, Retractor with Finger Ring
Gancho para coanas, Ganchito con anillo



LANGE
47563-22
23 cm, 9"

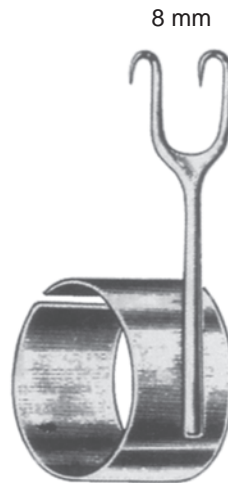

COTTLE
47568-08

Antrumküretten
Antrum Curettes
Curetas para el antro

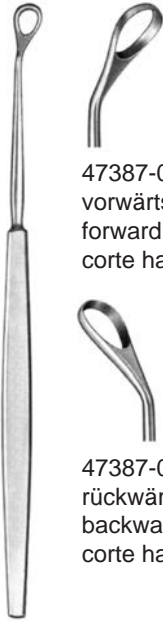

47387-01
vorwärts schneidend
forward cutting
corte hacia adelante



47387-02
rückwärts schneidend
backward cutting
corte hacia atras

ANTRUM
19 cm, 7 1/2"

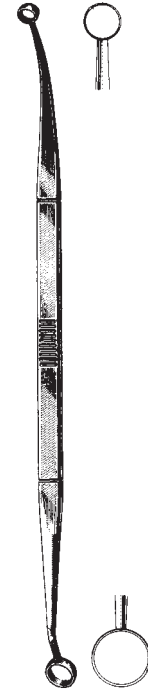

FAULKNER
47601-21
21 cm, 8 1/4"



47607-01
Fig. 1



47607-02
Fig. 2



47607-03
Fig. 3



47607-04
Fig. 4



47607-05
Fig. 5



47607-06
Fig. 6

COAKLEY
17 cm, 6 3/4"

Antrum Kürette, Antrumlöffel
Antrum Curettes
Cucharillas para antro



20 cm, 8"

Oval



47388-01
7 mm

47388-02
8 mm

47388-03
9 mm

Oval
30°



47388-04
2,5 mm

45°



47388-05
Ø 5 mm



19 cm, 7 1/2"



47399-01
55°



47399-02
90°

Scharfe Löffel
Bone Currettes
Cucharillas cortantes



33476-01
4,8 mm

33476-02
5,8 mm

33476-03
6,8 mm

biegsam
malleable
maleable

HALLE
21 cm, 8 1/4"

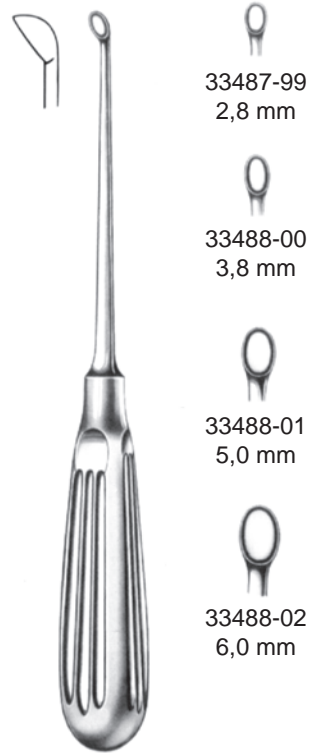

33487-99
2,8 mm

33488-00
3,8 mm

33488-01
5,0 mm

33488-02
6,0 mm

DAUBENSPECK
20 cm, 8"

Hämmer
Bone Mallets
Martillos

Ø 25 mm



GERZOG
33686-25
18 cm, 7" 250g

Ø 25 mm



33694-01 18,5 cm, 7 ¼", 135 g
33694-03 Ersatzbacken
Nylon Caps
Tapas de repuesto

Ø 25 mm



33694-02 18,5 cm, 7 ¼"
1 Nylonbacke
1 Nylon Cap
1 tapa de nylon

Ø 20 mm



MEAD
33693-32
17 cm, 6 ¾" 320 g

Hämmer
Bone Mallets
Martillos

Ø 42 mm

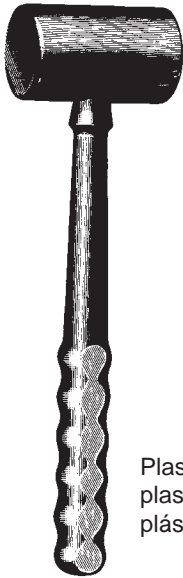

Plastik
plastic
plástico

33695-40
26 cm, 10 ¼"
400 g

Ø 12 mm



QUISLING
33696-75
17 cm, 6 ¾"

Ø 22 mm



PARTSCH
33698-98
18 cm, 7" 199 g

Ø 30 mm



COTTLE
33700-05
18 cm, 7" 240 g

Nasensonde, Dilatatoren
Nasal Probe, Dilators
Sondas nasales, Dilatadores



RITTER-HALLE

16 cm, 6 1/4"

47342-25 Ø 2,5 mm
47342-30 Ø 3,0 mm
47342-40 Ø 4,0 mm



SINUS

47420-03
18 cm, 7"



FRONTAL

47427-21
21 cm, 8 1/2"



WILDER
43602-01



WILDER
43602-02



WILDER
43602-03

Sonden
Probes
Sondas

geknöpft
buttoned
abotonada



rostfrei
stainless steel
acero inoxidable

Fig.	BOWMAN	Ø mm
0000/000	43613-00	0,6/0,7
00/0	43614-00	0,7/0,8
0/1	43614-01	0,8/0,9
1/2	43614-12	0,9/1,1
2/3	43614-23	1,1/1,3
3/4	43614-34	1,3/1,4
4/5	43614-45	1,4/1,5
5/6	43614-56	1,5/1,6
6/7	43614-67	1,6/1,8
7/8	43614-78	1,8/1,9

Wundhaken
Retractors
Separadores

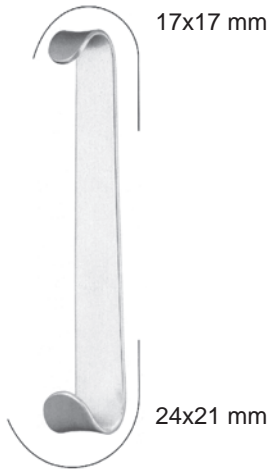

ROUX BABY
19122-13
13 cm, 5 1/8"

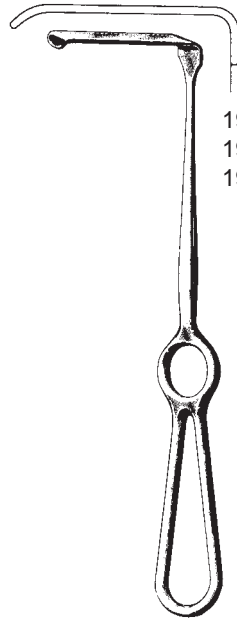

KOCHER-LANGENBECK
21 cm, 8 1/4"

- 19314-07 35x 7 mm
- 19314-14 70x14 mm
- 19314-20 60x20 mm

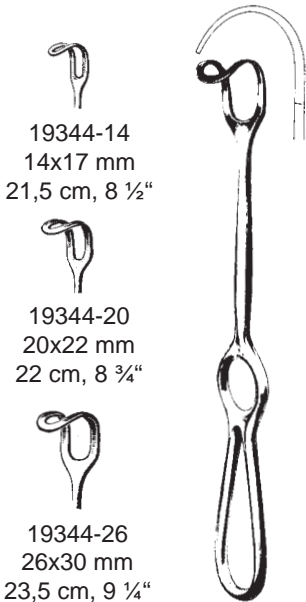

19344-14
14x17 mm
21,5 cm, 8 1/2"

19344-20
20x22 mm
22 cm, 8 3/4"

19344-26
26x30 mm
23,5 cm, 9 1/4"

MIDDELDORPF



BRÜNINGS-BRUNK
19499-00 19 cm, 7 1/2"

Kieferhöhlenhaken
Antrum Retractor
Separador para antro

Wundspreizer
Self-retaining Retractors
Separadores autoestáticos



stumpf
blunt
romo

PLESTER
19672-11
11 cm, 4 3/8"



stumpf
blunt
romo

PLESTER
19673-11
11 cm, 4 3/8"



2x2

scharf
sharp
agudo

PLESTER
19677-10 10 cm, 4"
19677-13 13 cm, 5 1/8"

Wundspreizer
Self-retaining Retractors
Separadores autoestáticos



FISCH
19690-17
17 cm, 6 3/4"



FISCH
19691-17
17 cm, 6 3/4"



Reda Instrumente GmbH
Gänsäcker 34 - P.O. Box 131
D-78532 Tuttlingen

**ADENOTOMIE UND
TONSILLEKTOMIE**

**ADENOTOMY AND
TONSILLECTOMY**

**ADENOTOMÍA Y
TONSILECTOMÍA**



www.Reda-Instrumente.de

Indikationen und Kontraindikationen finden Sie in der entsprechenden Gebrauchsanweisung!

Indication and Contraindication please refer to our user's manual!

Indicaciones y Contraindicaciones se encuentran en la instrucciones de uso correspondientes!

Zungenspatel, Wangen- und Lippenhalter
 Tongue Depressors, Cheek and Lip Retractors
 Baja-lenguas, Separadores para labios y mejillas



Holz
 wood
 madera

49102-16
 16 cm, 6 1/4"
 Pack. à 100



19 mm

23 mm

KROENIG
 49104-15
 15 cm, 6"

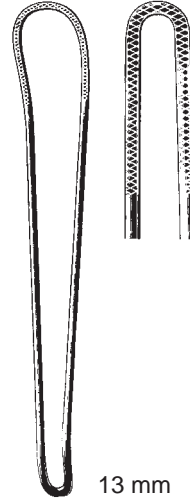

23 mm

13 mm

FRENZEL
 49105-16
 16,5 cm, 6 1/2"



16 mm

49106-01
 14,5 cm, 5 3/4"



15 mm

19 mm

BRUENINGS
 49107-19
 19 cm, 7 1/2"



20 mm

20 mm

CAWOOD-MINNESOTA
 49108-15
 15 cm, 6"



23 mm

19 mm

BUCHWALD
 49109-19
 19 cm, 7 1/2"

Zungendrucker
Tongue Depressors
Baja-lenguas



MORITZ-SCHMIDT
49110-19
19 cm, 7 1/2"



HARTMANN
49111-15
15 cm, 6"



49115-01
Fig. 1
14 cm, 5 1/2"

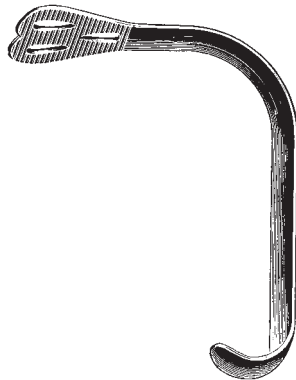

WIEDER
49115-01 - 49115-02



49115-02
Fig. 2
15 cm, 6"

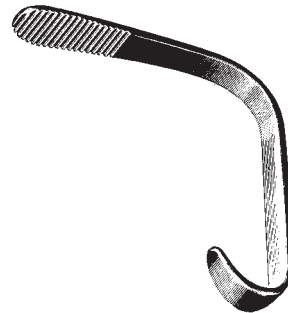

ANDREW
49117-11
11 cm, 4 3/8"

Zungendrucker, Wangen- und Lippenhalter, Zungenzangen
 Tongue Depressor, Cheek and Lip Retractor, Tongue Holding Forceps
 Baja-lenguas, Separadores para labios y mejillas, Pinza tira-lenguas

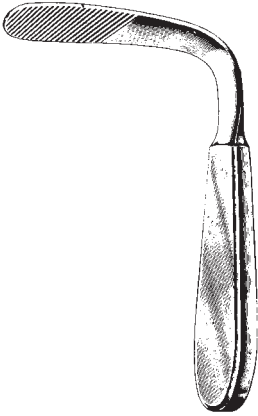

TOBOLD
 49119-14
 14,5 cm, 5 3/4"

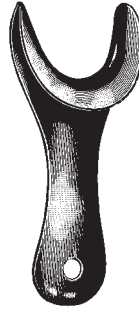

49230-11
 11 cm, 4 3/8"



26 mm
 37 mm
 STERNBERG
 49231-12 12 cm, 4 3/4"
 49231-14 14 cm, 5 1/2"
 49231-16 16 cm, 6 1/4"



49235-19
 19 cm, 7 1/2"

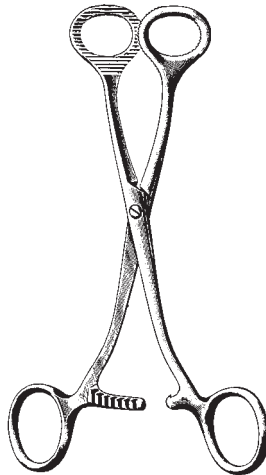

COLLIN
 49250-16 16 cm, 6 1/4"
 49250-18 18 cm, 7"

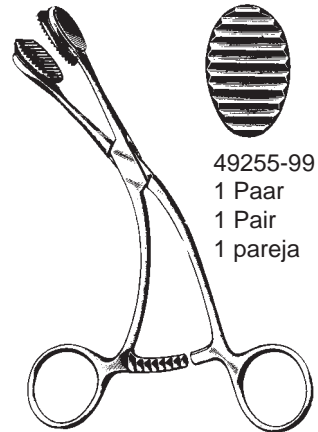

49255-99
 1 Paar
 1 Pair
 1 pareja

YOUNG
 49255-16
 16 cm, 6 1/4"

Mundsperrer
Mouth Gags
Abre-Bocas

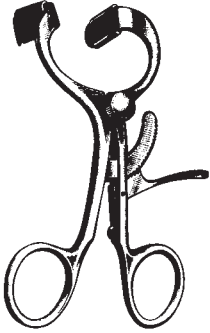

DOYEN-JANSEN (MOLT)
49265-12
12 cm, 4 3/4"

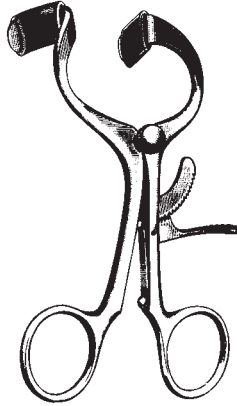

DOYEN-JANSEN (MOLT)
49265-14
14 cm, 5 1/2"

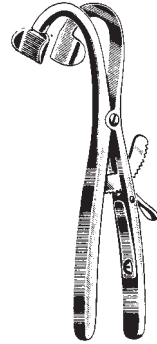

DENHART
49267-12
12 cm, 4 3/4"

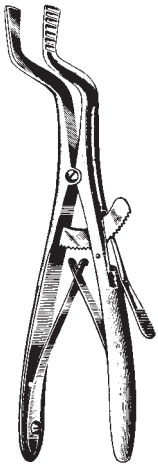

ROSER-KOENIG
49270-16 16 cm, 6 1/4"
49270-19 19 cm, 7 1/2"

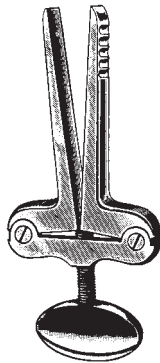

HEISTER
49272-13
13 cm, 5 1/8"

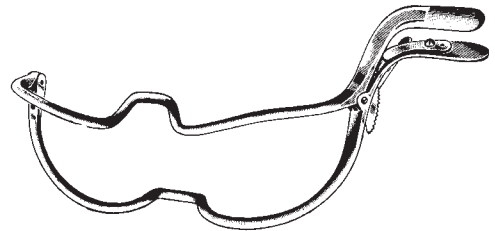

JENNINGS
49274-09 9 cm, 3 1/2"
49274-11 11 cm, 4 3/8"
49274-13 13 cm, 5 1/8"
49274-15 15 cm, 6"

Zungenspatel
Tongue Depressor
Baja-lengua



linke Seite
left side
izquierda

rechte Seite
right side
derecha

49287-02 RING Fig. 2
49287-03 Fig. 3
49287-04 Fig. 4
49287-05 Fig. 5

49288-02
49288-03
49288-04
49288-05

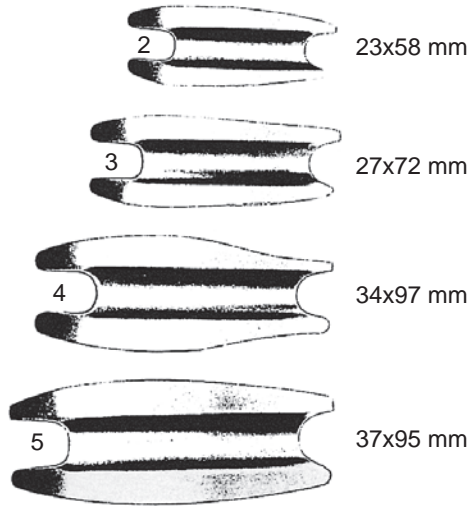

Zungenspatel
Tongue Depressor
Baja-lengua

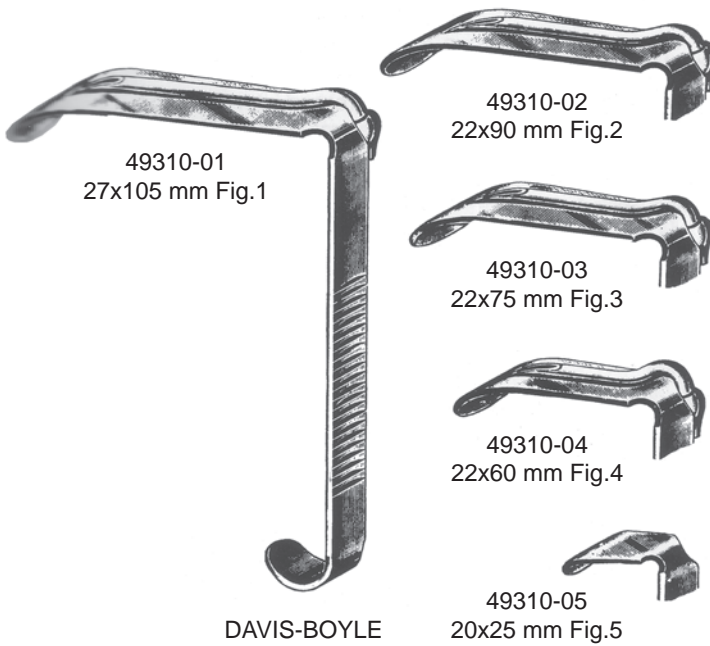

Mundsperrer
Mouth Gags
Abre-Bocas



Sperrer allein
Mouth Gag only
Abre-boca suelto

DAVIS-BOYLE

	für Erwachsene for adults para adultos	für Kinder for children para niños
links left izquierda	49310-10	49310-11
rechts right derecha	49310-12	49310-09

Mundsperrer
Mouth Gag
Abre-Bocas

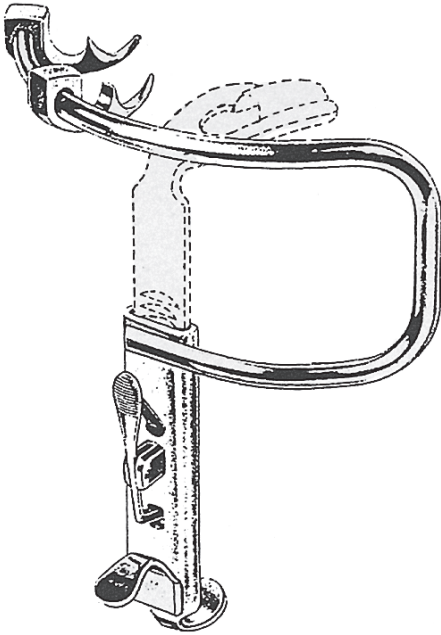

49315-10
Sperrer allein
Mouth Gag only
Abre-boca suelto

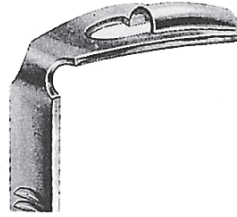

49315-01
37 x 80 mm
Fig. 1



49315-02
32 x 75 mm
Fig. 2

KILNER-DOUGHTY
49315-00
compl.

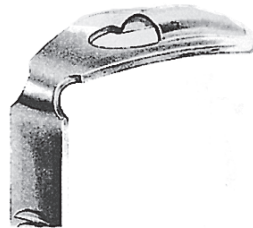

49315-03
28 x 65 mm
Fig. 3

Mundsperrer
Mouth Gag
Abre-Bocas

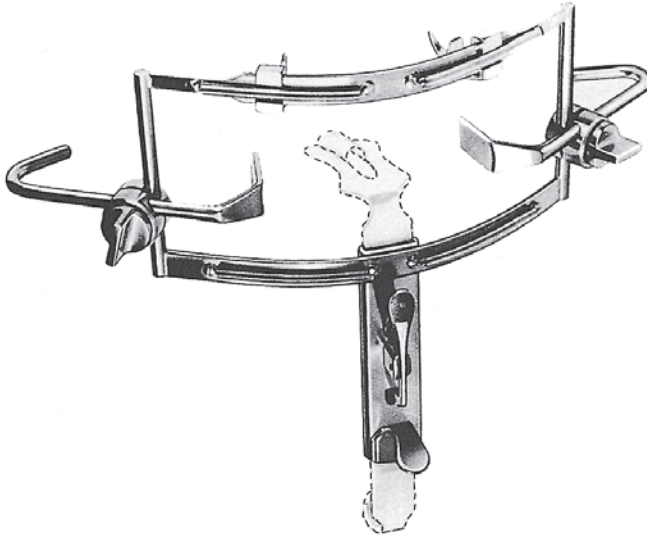

DINGMANN
49317-10
Sperrer allein / Mouth Gag only
Abre-boca suelto

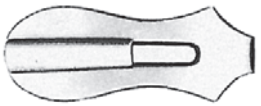

1 24x62 mm
49317-01



2 28x65 mm
49317-02

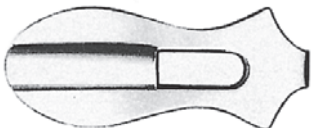

3 31x75 mm
49317-03

49317-00 DINGMANN, compl.

mit 3 auswechselbaren Zungendrucker,
2 seitliche Wangenhaken und 2 Zahnhaken

with 3 interchangeable tongue depressors,
2 rotating cheek holders
2 movable tooth hooks and thread guide

con 3 baja-lenguas intercambiables,
2 valvas giratorias p. los labios,
2 ganchos graduables

Mundsperrer, Gaumenplatte
Mouth Gags, Palate Blade
Abre-Bocas, placa para el paladar

49320-20
Silikon-Schlauch
Silicone Tubing
tubo de silicona

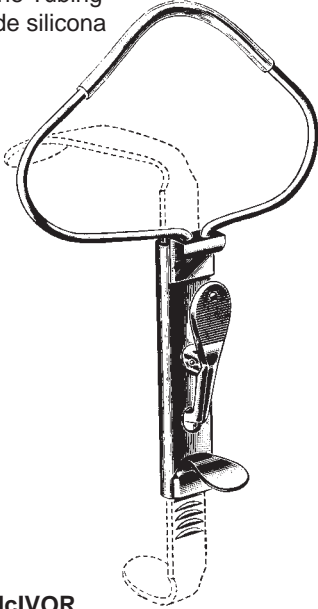

McIVOR
49320-00 compl. 49320-10

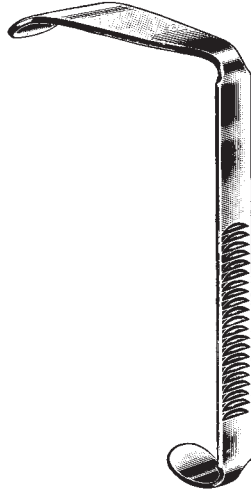

49320-01
27x95 mm Fig. 1



49320-02
22x85 mm Fig. 2

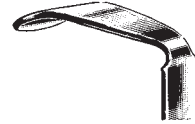

49320-03
22x70 mm Fig. 3



DAVIS-MEYER
49340-00



49341-00

Zungenspatel
Tongue Blades
Baja-lenguas



Zungenspatel
Tongue Blades
Baja-lenguas

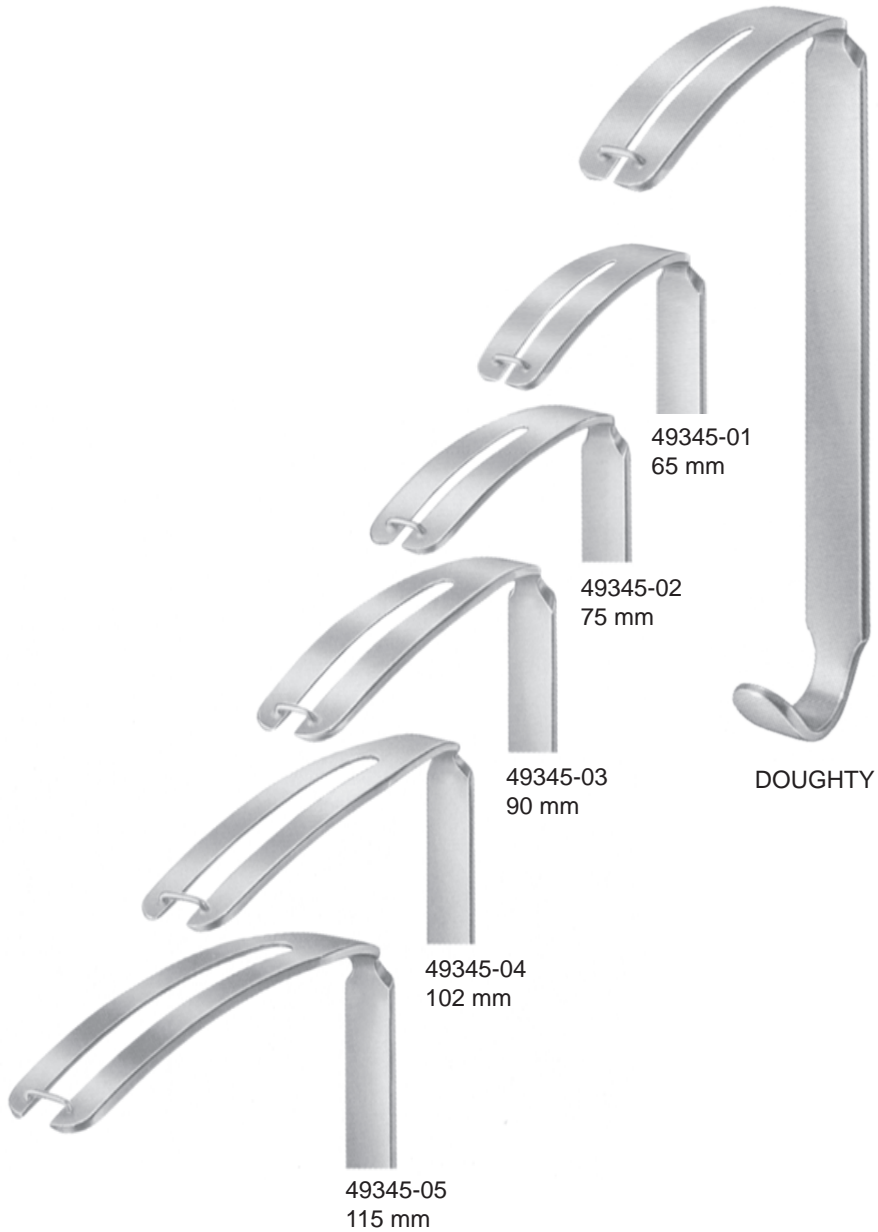

Mundkeil, Bruststütze
Oral Wedges, Chest Support
Abre-Bocas, Soporte de pecho

Holz
wood
madera



MAUNDER
49360-10



NEGUS
49400-01

Tonsillenzangen
Tonsil Forceps
Pinzas para coger las amígdalas

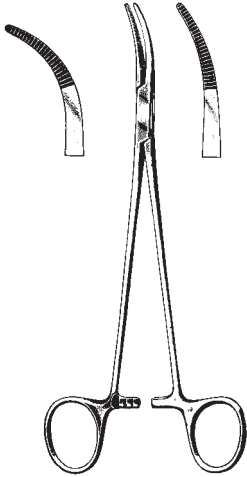

19 cm, 7 1/2"
SAWTELL SCHNIDT
51181-19 51183-19

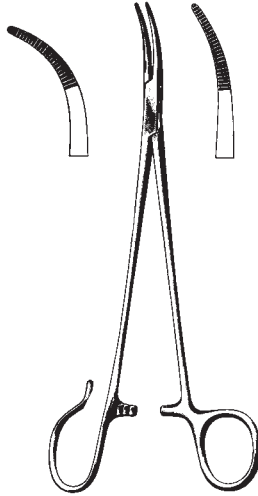

19 cm, 7 1/2"
SAWTELL SCHNIDT
51185-19 51187-19

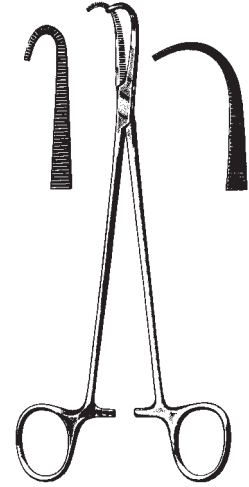

19 cm, 7 1/2"
NEGUS NEGUS
51191-19 51193-19

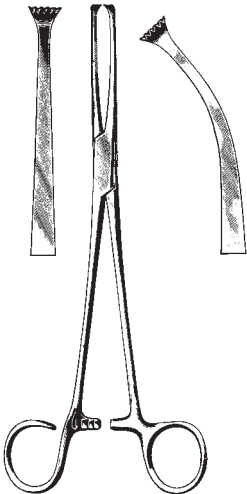

19 cm, 7 1/2"
COLVER
51202-19 51203-19

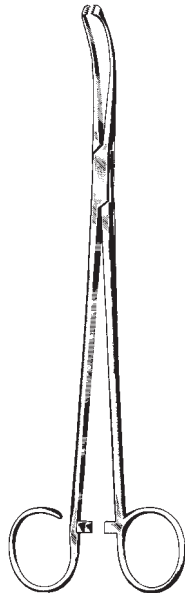

WHITE
51205-18 18 cm, 7"
51205-23 23 cm, 9"

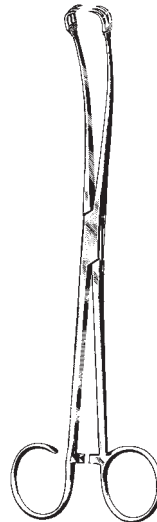

BALLENGER
51207-21
21,5 cm, 8 1/2"

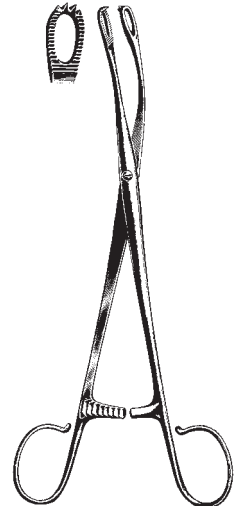

BLOHMKE
51209-20
20 cm, 8"

Tonsillenzangen, Tonsillenpinzette
Tonsil Forceps
Pinzas para amígdalas



ABRAHAM
51210-20
20 cm, 8"

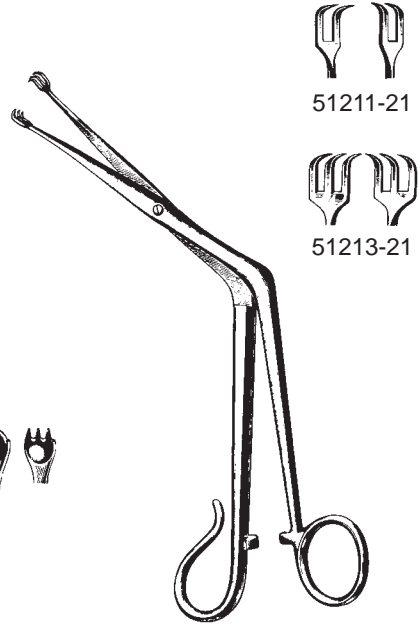

TYDING
21 cm, 8 ¼"

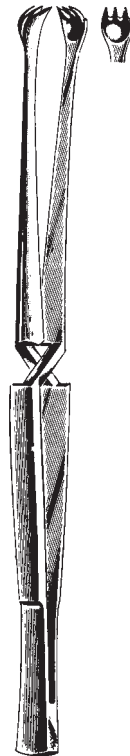

MARSCHIK
51219-22
22 cm, 8 ¾"

Tonsillenklemme, Tonsillenzange
Tonsil Forceps
Pinzas para amígdalas

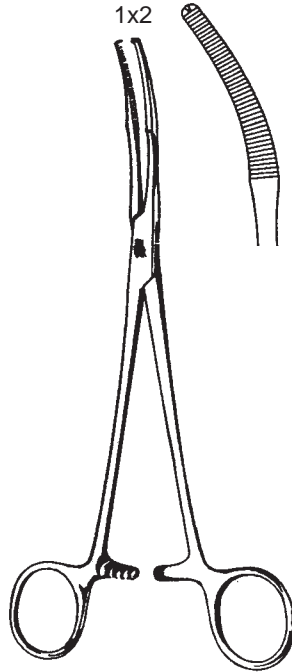

MIKULICZ
13551-18 18 cm, 7"



DENIS BROWNE
51214-20 20 cm, 8"



Tonsillenabszeßzange
Tonsil Abscess Forceps
Pinza para abscesos
en amígdalas

THILENIUS
51215-20 19 cm, 7 ½"

Saugrohr
Suction Tube
Tubo de succion

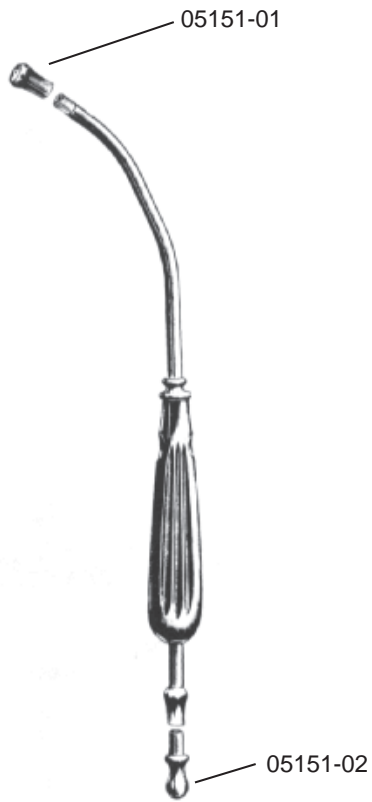

BABY-YANKAUER
05150-21 21 cm, 8 ¼"

YANKAUER, compl.
05150-27 27 cm, 10 ½"

Tonsillennadeln
Tonsil Needles
Agujas para amígdalas

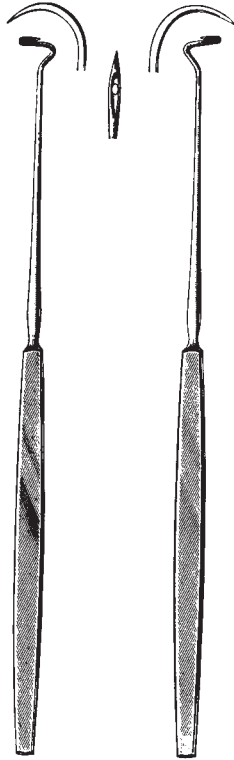

DUPUY-WEISS
51165-22 51167-22
22 cm 8 ³/₄"



CLAUS
51168-23
23 cm 9"

Tonsillennadeln, Tonsillenmesser
Tonsil Needles, Tonsil Knives
Agujas para amígdalas, Bisturios para amígdalas



NAGER
51170-24
24 cm 9 ½"



FISHER
51171-22
22,5 9"

Tonsillenmesser
Tonsil Knives
Bisturios para amígdalas



ABRAHAM
51172-19
19 cm, 7 ½"



ABRAHAM
51173-21
21 cm, 8 ¼"



CANFIELD
51174-21
21 cm, 8 ¼"



BRUENINGS
51177-23
23 cm, 9"

Uvulahaken
Uvula Retractors
Separadores uvulares

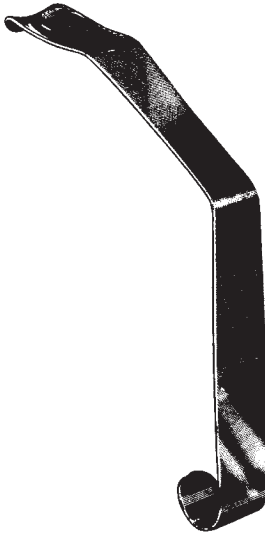

LOVE 15 cm, 6"
51103-18 18 mm
51103-20 20 mm
51103-22 22 mm

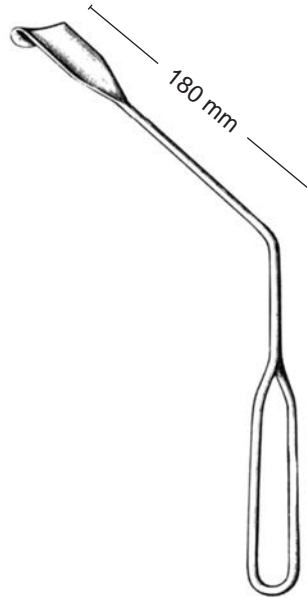

LOTHROP
51104-18 18 mm

Gaumensegelhalter
Soft Palate Retractors
Separadores para la vela palatina

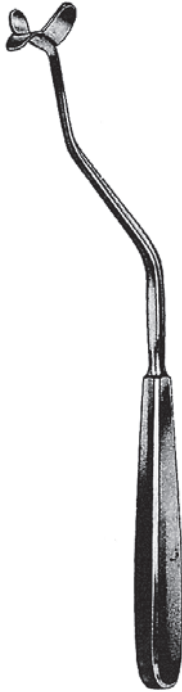

HOFER
51109-24
24 cm, 9 1/2"



NAGER
51111-23
23 cm, 9"

Tonsillenelevatorien, Tonsillendisektoren
Tonsil Elevators, Tonsil Dissectors
Elevadores/disectores para amígdalas

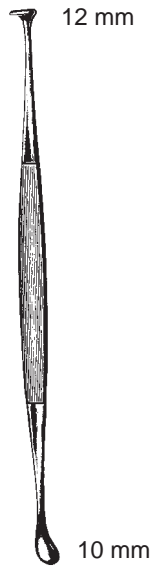

HURD
51131-22
22 cm, 8 1/4"



LOPEZ-REINKE
51133-23
23 cm, 9"



YANKAUER
51134-21
21 cm, 8 1/4"

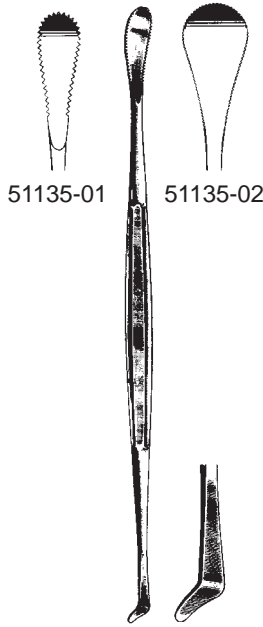

HENKE
23 cm, 9"



ALDERDYCE
33761-21
21 cm, 8 1/4"

Tonsillendissektoren
Tonsil Dissectors
Disectores para amígdalas

Enukleator
Enucleator
Enucleador



CARPENTER
51139-25
25 cm, 10"

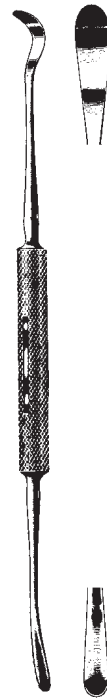

CARPENTER
51143-24
24 cm, 9 1/2"

Tamponstopfer
Gauze Packer
Tamponador tonsilar

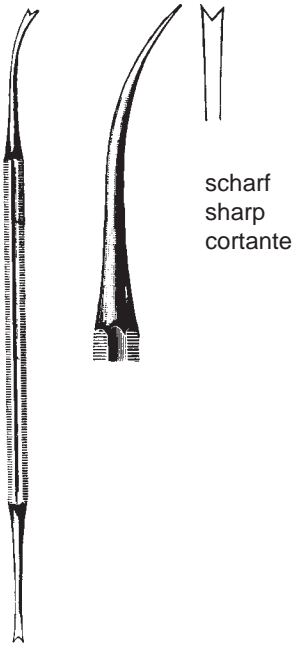

LUNIATSCHEK
51151-19
19 cm, 7 ½"

Speichelgangsonde
Salivary Duct Probe
Sonda para el canal de saliva

geknöpft
buttoned
abotonada



rostfrei
stainless steel
acero inoxidable

Fig.	BOWMAN	Ø mm
0000/000	43613-00	0,6/0,7
00/0	43614-00	0,7/0,8
0/1	43614-01	0,8/0,9
1/2	43614-12	0,9/1,1
2/3	43614-23	1,1/1,3
3/4	43614-34	1,3/1,4
4/5	43614-45	1,4/1,5
5/6	43614-56	1,5/1,6
6/7	43614-67	1,6/1,8
7/8	43614-78	1,8/1,9

Anatomische und chirurgische Pinzetten
Dressing and Tissue Forceps
Pinzas de disección, sin/con dientes



POTTS-SMITH

- | | | |
|----------|-------------|-------------|
| 11112-18 | 18 cm, 7" | 11116-18 TC |
| 11112-21 | 21 cm, 8 ¼" | 11116-21 TC |
| 11112-25 | 25 cm, 10" | 11116-25 TC |



1x2

POTTS-SMITH

- | | |
|----------|-------------|
| 11126-18 | 18 cm, 7" |
| 11126-21 | 21 cm, 8 ¼" |
| 11126-25 | 25 cm, 10" |

Tupferzangen
Dressing Forceps
Pinzas porta-esponjas



DUPLAY
17131-21 21 cm, 8 1/4"



17133-17 17 cm, 6 3/4"

Tonsillenscheren
Tonsil Scissors
Tijeras para amígdalas

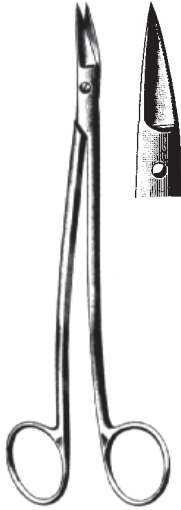

— DEAN ~~~~
09425-17 09427-17
17 cm, 6 ¾"

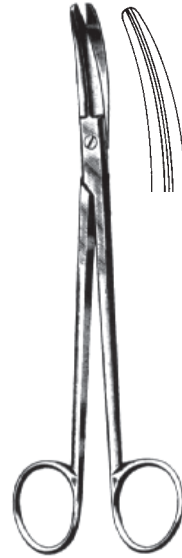

BOETTCHER
09435-18
18 cm, 7"

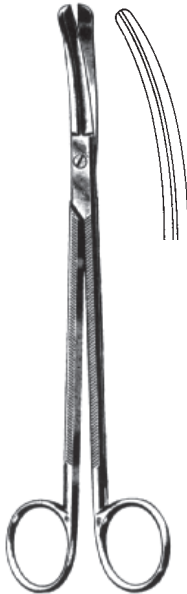

GOOD
09437-19
19 cm, 7 ½"

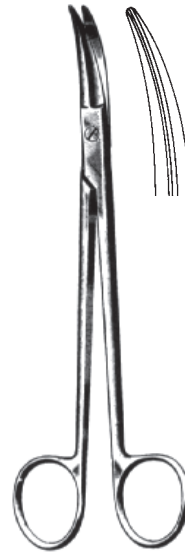

PRINCE
09439-17
17 cm, 6 ¾"

Präparierscheren
Dissecting Scissors
Tijeras de disección

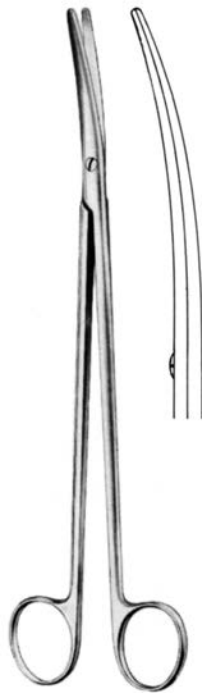

METZENBAUM

- 09281-12 09285-12 TC
12 cm 4 3/4"
- 09281-15 09285-15 TC
15 cm 6"
- 09281-18 09285-18 TC
18 cm 7"
- 09281-20 09285-20 TC
20 cm 8"
- 09281-23 09285-23 TC
23 cm 9"
- 09281-25 09285-25 TC
25 cm 10"
- 09281-28 09285-28 TC
28 cm 11"
- 09281-30 09285-30 TC
30 cm 12"

Speichelgangschere
Salival Scissors
Tijeras para el canal de saliva

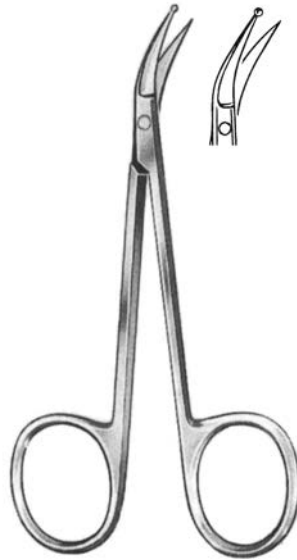

PERWITZSCHKY
09364-10
10 cm, 4"

Draht-, Blechschere
Wire and Plate Scissors
Tijeras para alambre y láminas

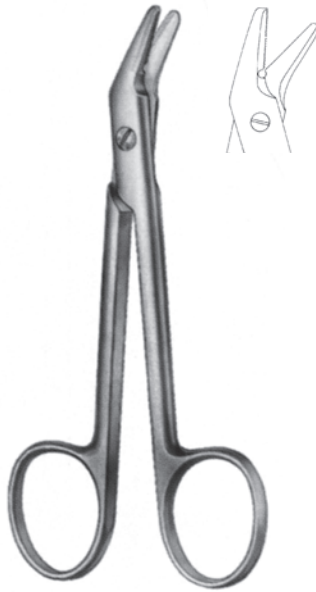

UNIVERSAL

09831-12 12 cm, 4 ¾"

09835-12 TC 12 cm, 4 ¾"

Tonsillenschnürer
Tonsil Snares
Cierranudos para amígdalas

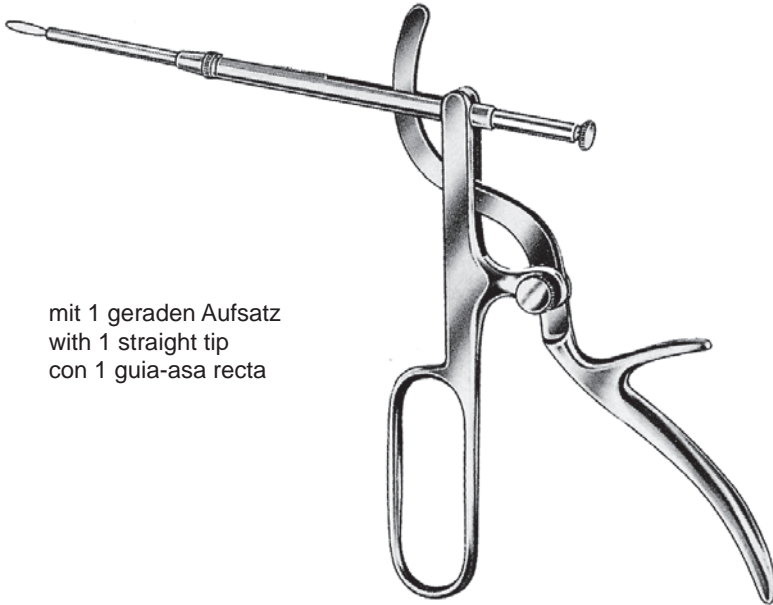

mit 1 geraden Aufsatz
with 1 straight tip
con 1 guía-asa recta

TYDING
51260-00

Tonsillenschnürer
Tonsil Snares
Cierranudos para amígdalas



EVES
51250-28
28 cm, 11"



EVES
51252-28
28 cm, 11"



BRUENINGS
51256-28
28 cm, 11"

Tonsillendraht
Tonsil Wire
Hilos para amígdalas

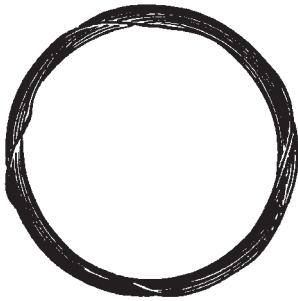

mm Ø
34520-02 0,2
34520-03 0,3
34520-04 0,4

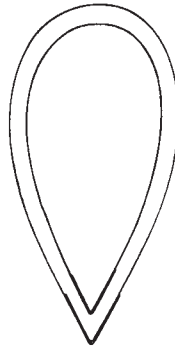

51257-40 40 mm
51257-50 50 mm
Pack of 100 pcs



51259-03 0,3 mm
51259-04 0,4 mm
51259-05 0,5 mm
Pack of 12 pcs

Tonsillenschnürer
Tonsil Snares
Cierranudos para amígdalas

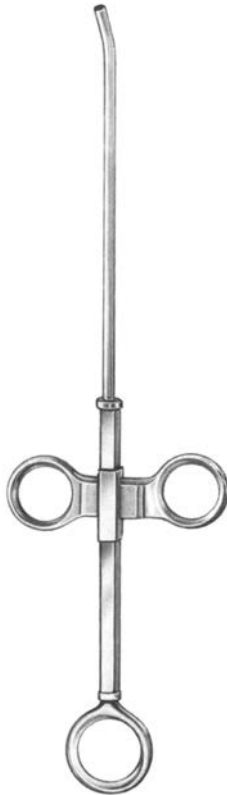

ROEDER "E"
51265-00
27 cm, 10 $\frac{3}{4}$ "

Fadengabel
Knot Tier
Horquilla de hilos



NEGUS
51176-20
20,5 cm, 8"

Tonsillotom
Tonsillectome
Amigdalótomo



SLUDER-BALLENGER
51270-00
mit 3 Aufsätzen
with 3 blades
con 3 hojas

Septum Nadeln, Spritzen
Septum Needles, Syringes
Agujas para septum, Jeringas



51291-00
2,5 mm Ø

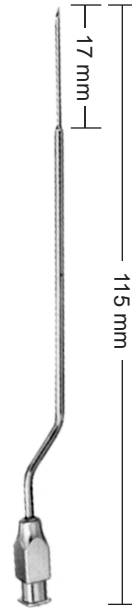

51293-00
0,8 mm Ø

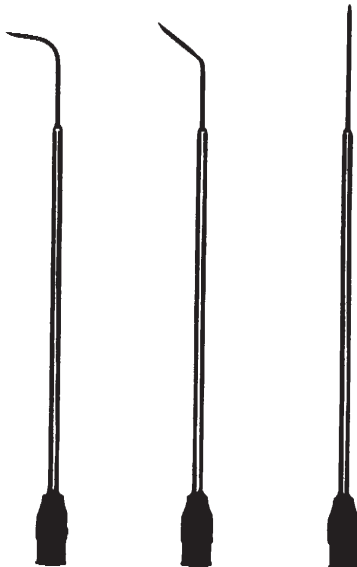

51293-90
90°

51293-45
45°

51292-00

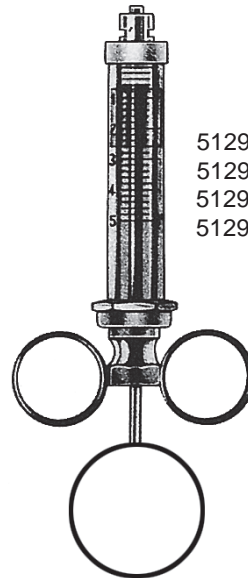

51290-02 2 ml
51290-05 5 ml
51290-10 10 ml
51290-20 20 ml

Tonsillenzangen
Tonsil Punches
Pinzas para amígdalas

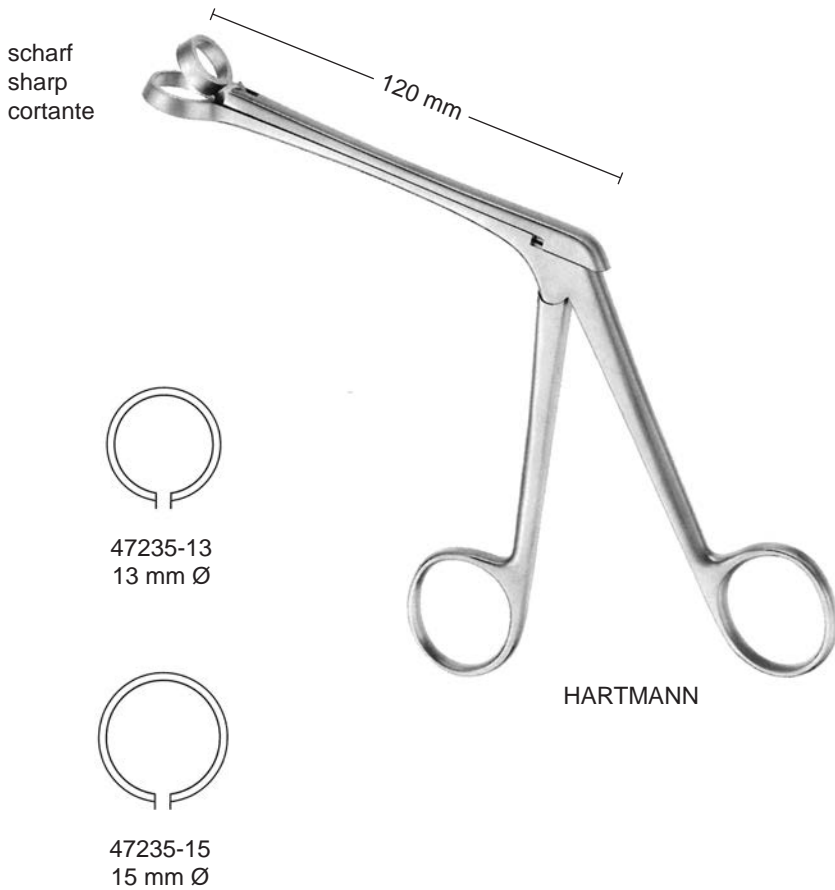

Ringmesser
Adenoid Curettes
Cuchillos para vegetaciones adenoideas



BECKMANN
22 cm, 8 3/4"

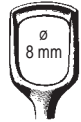

47620-00
Fig. 0

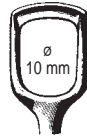

47620-01
Fig. 1

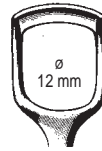

47620-02
Fig. 2

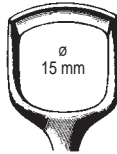

47620-03
Fig. 3

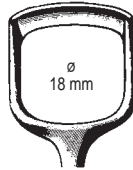

47620-04
Fig. 4

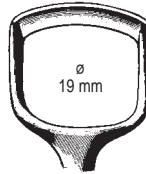

47620-05
Fig. 5

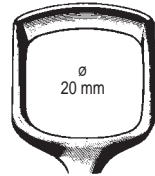

47620-06
Fig. 6



BARNHILL
21 cm, 8 1/4"



47630-00
Fig. 0



47630-01
Fig. 1



47630-02
Fig. 2

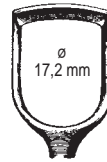

47630-03
Fig. 3

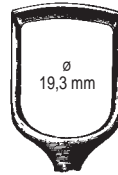

47630-04
Fig. 4

Ringmesser, Adenotome
 Adenoid Currettes, Adenotomes
 Cuchillos para vegetaciones adenoideas, Adenotomos

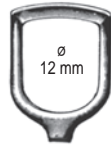

47636-01
 Fig. 1



47636-02
 Fig. 2



47636-03
 Fig. 3

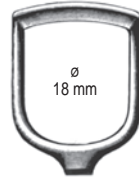

47636-04
 Fig. 4

St. CLAIR-THOMSON
 21 cm, 8 1/4"



47641-01
 Fig. 1
 ø 12 mm



47641-02
 Fig. 2
 ø 16 mm



47641-03
 Fig. 3
 ø 18 mm

Ersatzklingen allein, gelocht
 Spare blades, perforated
 Hojas de repuesto, perforadas

Fig. 1 47642-01
 Fig. 2 47642-02
 Fig. 3 47642-03

LAFORCE
 25 cm, 10"

Nasentrachenzangen
Naso Pharyngeal Forceps
Pinzas naso-faringeas



JATHO
47243-00
24 cm, 9 1/2"



scharf
sharp
cortante

ST. CLAIR-THOMSON
47246-18 18 cm, 7 1/8"

Nasenrachenzangen
Naso Pharyngeal Forceps
Pinzas naso-faringeas

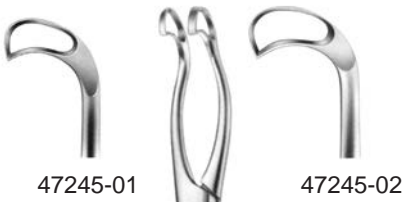

47245-01

47245-02



JURASZ
21 cm, 8 ¼"



für Kinder, scharf
for children, sharp
para niños, cortante

JURASZ
47244-00 19 cm, 7 ½"

Reda Instrumente GmbH
Gänsäcker 34 - P.O. Box 131
D-78532 Tuttlingen



TRACHEOTOMIE

TRACHEOTOMY

TRAQUEOTOMÍA



www.Reda-Instrumente.de

Indikationen und Kontraindikationen finden Sie in der entsprechenden Gebrauchsanweisung!
Indication and Contraindication please refer to our user's manual!
Indicaciones y Contraindicaciones se encuentran en la instrucciones de uso correspondientes!

Tracheal Dilatatoren, Trachealhaken, Trachealwundspreizer
Tracheal Dilators, Tracheal Hooks, Tracheal Retractors
Dilatadores traqueales, Ganchos traqueales, Retractor traqueal

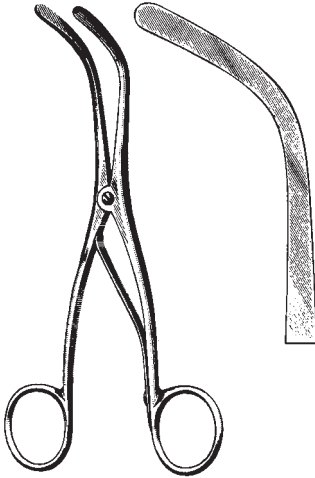

TROUSSEAU-BABY
55111-13 13 cm, 5 1/8"

TROUSSEAU
55111-14 14 cm, 5 1/2"

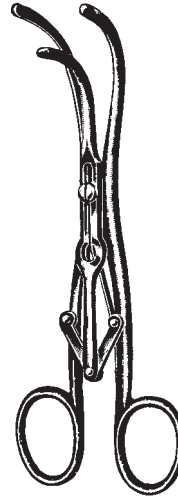

LABORDE
55113-14
14 cm, 5 1/2"



BOSE
55115-07
7 cm, 2 3/4"

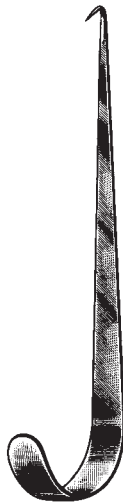

JACKSON
55116-15
15 cm, 6"



JACKSON
55117-17
17 cm, 6 3/4"

Trachealhaken, Kanülen
 Tracheal Hooks, Tubes
 Ganchos traqueales Cánulas



Trachealkanülen
Tracheal Tubes
Canulas traqueales

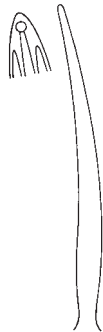

Fig.	Ø mm	Länge des Außenrohrs Length of outer tube Largo de la cánula exterior	LUER Neusilber German silver alpaca	CHEVALIER-JACKSON Neusilber German silver alpaca
0	4	45 mm	55220-04	55240-04
1	5	50 mm	55220-05	55240-05
2	6	55 mm	55220-06	55240-06
3	7	60 mm	55220-07	55240-07
4	8	65 mm	55220-08	55240-08
5	9	70 mm	55220-09	55240-09
6	10	75 mm	55220-10	55240-10
7	11	80 mm	55220-11	55240-11
8	12	85 mm	55220-12	55240-12
9	13	90 mm	55220-13	55240-13

Kropfsonde, Schilddrüsenhaken
Thyroid Dissectors, Thyroid Retractor
Sondas para bocio, Separador para la glándula tiroidea



55501-15



55503-15

KOCHER
15 cm, 6"



SCHOENBORN
55511-21
21 cm, 8 1/4"

Kropffasszange, Muskelklemme
Goitre Seizing Forceps, Muscular Clamp
Pinza para coger el bocio, Pinza para músculos

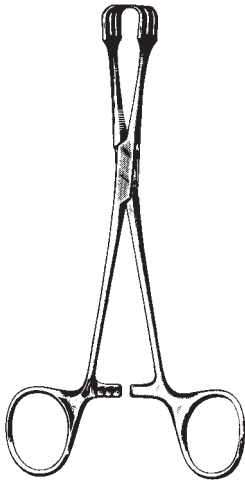

LAHEY
55520-15 15 cm, 6"
55520-20 20 cm, 8"

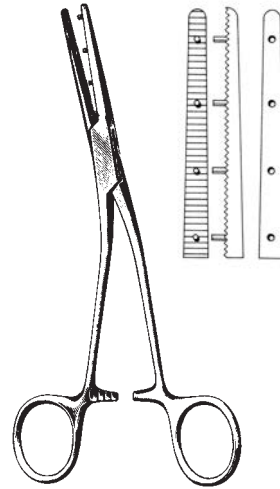

MASTIN
55523-17
17 cm, 6 3/4"

Kehlkopf Polypenschnürer
Laryngeal Polypus Snare
Cierranudo para pólipos



51259-04
Ø 0,4 mm
Pack of 12 pcs

Schnürerdraht
Snare Wire
Alambre para polipotomo



53122-00
Nutzlänge 24 cm, 9 ½"
Working length 24 cm, 9 ½"
Largo útil 24 cm, 9 ½"



Reda Instrumente GmbH
Gänsäcker 34 - P.O. Box 131
D-78532 Tuttlingen

**LARYNGOSKOPIE
ENDOLARYNGEALE
MIKROCHIRURGIE**

**LARYNGOLOGY
ENDOLARYNGEAL
MICROSURGERY**

**LARINGOSCOPIA
MICRO CIRUGIA
ENDOLARINGEAL**



www.Reda-Instrumente.de

Indikationen und Kontraindikationen finden Sie in der entsprechenden Gebrauchsanweisung!

Indication and Contraindication please refer to our user's manual!

Indicaciones y Contraindicaciones se encuentran en la instrucciones de uso correspondientes!

Kaltlicht Laryngoskope
Fiber Optic Laryngoscopes
Laringoscopios de luz fría



Kaltlicht
Cold Light
Luz fría



McINTOSH

05212-03

Set bestehend aus:

- 1 Etui
- 1 Batteriegriff 05238-03
- 3 Spatel (Fig. 2-4)
- 1 Ersatzlampe Xenon 05239-03

Set consisting of:

- 1 Case
- 1 Handle 05238-03
- 3 Blades (Fig. 2-4)
- 1 Spare Bulb Xenon 05239-03

Juego compuesto de:

- 1 Estuche
- 1 Mango 05238-03
- 3 Hojas (Fig. 2-4)
- 1 Bombilla de recambio Xenon 05239-03

05212-04

Set bestehend aus:

- 1 Etui
- 1 Batteriegriff 05238-03
- 4 Spatel (Fig. 1-4)
- 1 Ersatzlampe Xenon 05239-03

Set consisting of:

- 1 Case
- 1 Handle 05238-03
- 4 Blades (Fig. 1-4)
- 1 Spare Bulb Xenon 05239-03

Juego compuesto de:

- 1 Estuche
- 1 Mango 05238-03
- 4 Hojas (Fig. 1-4)
- 1 Bombilla de recambio Xenon 05239-03

Laryngoskopie-Spatel mit integriertem Kaltlichtträger
Laryngoscope Blades with Integrated Cold Light Carrier
Espátulas de laringoscopios con luz fría integrada

Kaltlicht
Cold Light
Luz fría



McINTOSH



05211-00
59 mm, 2.32"
Nutzlänge
working length
largo útil

Fig. 0
für Säuglinge
for babies
para neonatales



05211-01
72 mm, 2.83"
Nutzlänge
working length
largo útil

Fig. 1
für Kinder
for children
para niños



05211-02
92 mm, 3.62"
Nutzlänge
working length
largo útil

Fig. 2
für Jugendliche
for adolescents
para adolescentes



05211-03
112 mm, 4.41"
Nutzlänge
working length
largo útil

Fig. 3
für Frauen
for women
para mujeres



05211-04
136 mm, 5.35"
Nutzlänge
working length
largo útil

Fig. 4
für Männer
for men
para hombres

Laryngoskopie Spatel mit integriertem Kaltlichtträger
Laryngoscope Blades with Integrated Cold Light Carrier
Espátulas de laringoscopios con luz fría integrada



Kaltlicht
Cold Light
Luz fría



McCOY

		Nutzlänge working length largo útil
Fig. 2	05217-02	92 mm
Fig. 3	05217-03	112 mm
Fig. 4	05217-04	136 mm

Kaltlicht
Cold Light
Luz fría



Kaltlicht Laryngoskope
Fiber Optic Laryngoscopes
Laringoscopios de luz fría



MILLER

05213-03CL

Set bestehend aus:

- 1 Etui
- 1 Batteriegriff 05238-03
- 3 Spatel (Fig. 1-3)
- 1 Ersatzlampe Xenon 05239-03

Set consisting of:

- 1 Case
- 1 Handle 05238-03
- 3 Blades (Fig. 1-3)
- 1 Spare Bulb Xenon 05239-03

Juego compuesto de:

- 1 Estuche
- 1 Mango 05238-03
- 3 Hojas (Fig. 1-3)
- 1 Bombilla de recambio Xenon 05239-03

05213-04CL

Set bestehend aus:

- 1 Etui
- 1 Batteriegriff 05238-03
- 4 Spatel (Fig. 1-4)
- 1 Ersatzlampe Xenon 05239-03

Set consisting of:

- 1 Case
- 1 Handle 05238-03
- 4 Blades (Fig. 1-4)
- 1 Spare Bulb Xenon 05239-03

Juego compuesto de:

- 1 Estuche
- 1 Mango 05238-03
- 4 Hojas (Fig. 1-4)
- 1 Bombilla de recambio Xenon 05239-03

Laryngoskopie-Spatel mit integriertem Kaltlichtträger
Laryngoscope Blades with Integrated Cold Light Carrier
Espátulas de laringoscopios con luz fría integrada



Kaltlicht
Cold Light
Luz fría

MILLER



05230-00CL
55 mm, 2.16"
Nutzlänge
working length
largo útil

Fig. 0
für Säuglinge
for babies
para neonatales



05230-01CL
80 mm, 3.15"
Nutzlänge
working length
largo útil

Fig. 1
für Kinder
for children
para niños



05230-02CL
130 mm, 5.12"
Nutzlänge
working length
largo útil

Fig. 2
für Jugendliche
for adolescents
para adolescentes



05230-03CL
170 mm, 6.69"
Nutzlänge
working length
largo útil

Fig. 3
für Frauen
for women
para mujeres



05230-04CL
188 mm, 7.4"
Nutzlänge
working length
largo útil

Fig. 4
für Männer
for men
para hombres

Laryngoskope Warmlicht
Laryngoscopes Warm Light
Laringoscopios de luz caliente

Warmlicht
Warm Light
Luz caliente



McINTOSH

05203-00

Set bestehend aus:

- 1 Etui
- 1 Batteriegriff 05234-28
- 3 Spatel (Fig. 2-4)
- 2 Ersatzlampen 05239-02

Set consisting of:

- 1 Case
- 1 Handle 05234-28
- 3 Blades (Fig. 2-4)
- 2 Spare Bulbs 05239-02

Juego compuesto de:

- 1 Estuche
- 1 Mango 05234-28
- 3 Hojas (Fig. 2-4)
- 2 Bombilla de recambio 05239-02

05204-00

Set bestehend aus:

- 1 Etui
- 1 Batteriegriff 05234-28
- 4 Spatel (Fig. 1-4)
- 2 Ersatzlampen 05239-02

Set consisting of:

- 1 Case
- 1 Handle 05234-28
- 4 Blades (Fig. 1-4)
- 2 Spare Bulbs 05239-02

Juego compuesto de:

- 1 Estuche
- 1 Mango 05234-28
- 4 Hojas (Fig. 1-4)
- 1 Bombilla de recambio 05239-02

Laryngoskopie-Spatel mit integriertem Warmlichtträger
Laryngoscope Blades with Integrated Warm Light Carrier
Espátulas de laringoscopios con luz caliente integrada



Warmlicht
Warm Light
Luz caliente

McINTOSH



05210-00
59 mm, 2.32"
Nutzlänge
working length
largo útil

Fig. 0
für Säuglinge
for babies
para neonatales



05210-01
72 mm, 2.83"
Nutzlänge
working length
largo útil

Fig. 1
für Kinder
for children
para niños



05210-02
92 mm, 3.62"
Nutzlänge
working length
largo útil

Fig. 2
für Jugendliche
for adolescents
para adolescentes



05210-03
112 mm, 4.41"
Nutzlänge
working length
largo útil

Fig. 3
für Frauen
for women
para mujeres



05210-04
136 mm, 5.35"
Nutzlänge
working length
largo útil

Fig. 4
für Männer
for men
para hombres

Laryngoskope Warmlicht
Laryngoscopes Warm Light
Laringoscopios de luz caliente

Warmlicht
Warm Light
Luz caliente



MILLER

05213-03

Set bestehend aus:

- 1 Etui
- 1 Batteriegriff 05234-28
- 3 Spatel (Fig. 1-3)
- 1 Ersatzlampe 05239-01
- 1 Ersatzlampe 05239-02

Set consisting of:

- 1 Case
- 1 Handle 05234-28
- 3 Blades (Fig. 1-3)
- 1 Spare Bulb 05239-01
- 1 Spare Bulb 05239-02

Juego compuesto de:

- 1 Estuche
- 1 Mango 05234-28
- 3 Hojas (Fig. 1-3)
- 1 Bombilla de recambio 05239-01
- 1 Bombilla de recambio 05239-02

05213-04

Set bestehend aus:

- 1 Etui
- 1 Batteriegriff 05234-28
- 4 Spatel (Fig. 1-4)
- 1 Ersatzlampe 05239-01
- 1 Ersatzlampe 05239-02

Set consisting of:

- 1 Case
- 1 Handle 05234-28
- 4 Blades (Fig. 1-4)
- 1 Spare Bulb 05239-01
- 1 Spare Bulb 05239-02

Juego compuesto de:

- 1 Estuche
- 1 Mango 05234-28
- 4 Hojas (Fig. 1-4)
- 1 Bombilla de recambio 05239-01
- 1 Bombilla de recambio 05239-02

Laryngoskope Warmlicht
Laryngoscopes Warm Light
Laringoscopios de luz caliente



Warmlicht
Warm Light
Luz caliente

MILLER



05230-00
55 mm, 2.16"
Nutzlänge
working length
largo útil

Fig. 0
für Säuglinge
for babies
para neonatales



05230-01
80 mm, 3.15"
Nutzlänge
working length
largo útil

Fig. 1
für Kinder
for children
para niños



05230-02
130 mm, 5.12"
Nutzlänge
working length
largo útil

Fig. 2
für Jugendliche
for adolescents
para adolescentes



05230-03
170 mm, 6.69"
Nutzlänge
working length
largo útil

Fig. 3
für Frauen
for women
para mujeres



05230-04
188 mm, 7.4"
Nutzlänge
working length
largo útil

Fig. 4
für Männer
for men
para hombres

Laryngoskope Warmlicht
Laryngoscopes Warm Light
Laringoscopios de luz caliente

Warmlicht
Warm Light
Luz caliente

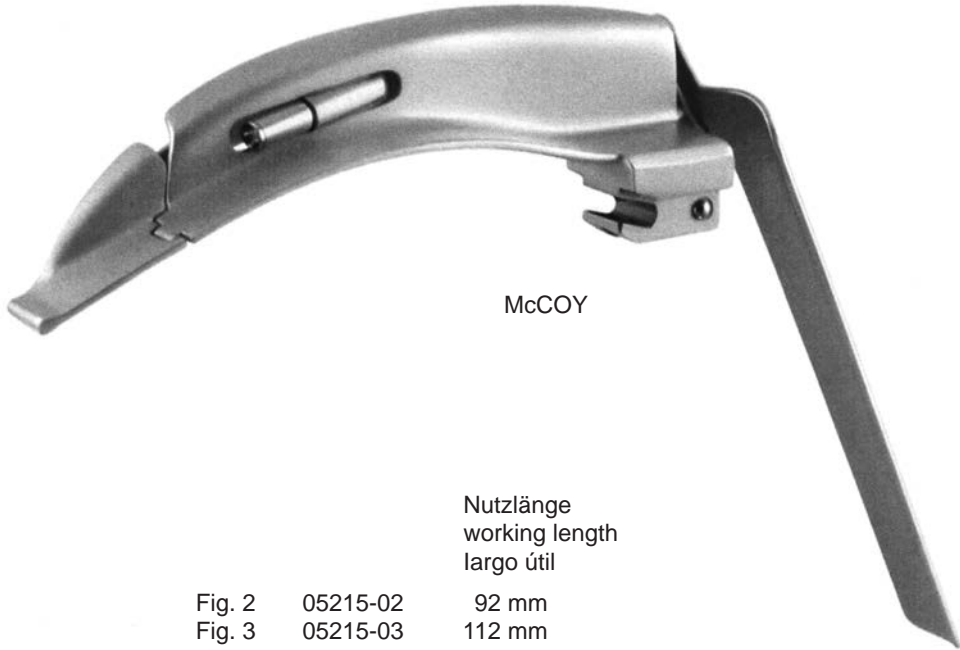

McCOY

Nutzlänge
working length
largo útil

Fig. 2	05215-02	92 mm
Fig. 3	05215-03	112 mm
Fig. 4	05215-04	136 mm

Batteriegriffe, Edelstahl
Battery Handles, Stainless Steel
Mango de pila, acero inoxidable



Kaltlicht
Cold Light
Luz fría



15,5 cm
19 mm Ø

05238-02



15,5 cm
28 mm Ø

05238-03



05239-03 Xenon 2,5 V

Ersatzlampe
Spare Bulb
Bombilla de recambio

mit Xenon-Lampe
with Xenon-Lamp
con lampara Xenon

05238-12

05238-13

mit LED-Lampe
with LED-Lamp
con lampara LED

Warmlicht
Warm Light
Luz caliente



Batteriegriffe, Edelstahl
Battery Handles, Stainless Steel
Mango de pila, acero inoxidable



05233-18
14 cm
19 mm Ø



05234-28
14,5 cm
29 mm Ø

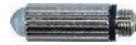

05239-01 2,5 V
Fig. 0-1

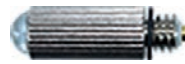

05239-02 2,5 V
Fig. 2-4

Ersatzlampe
Spare Bulb
Bombilla de recambio

Operations-Laryngoskope
 Operation Laryngoscope
 Laringoscopios operativo

rostfreier Edelstahl
 Rohr: innen matt/außen glänzend
 Griff: matt

stainless steel
 tube: inner surface mat/outer
 surface polished
 handle: mat

acero inoxidable
 Pala: Superficie interior: mate
 Superficie exterior: brillante
 Mango: mate

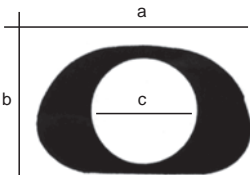

Nr.	L (mm)	a (mm)	b (mm)	c (mm)	Lichtträger light guide Portador de luz
05301-01	130	19,5	12,0	10,5	05302-01
05301-02	150	20,5	13,0	10,5	05302-01
05301-03	170	26,0	15,5	13,5	05302-02
05301-04	170	28,5	18,5	15,0	05302-02
05301-05	170	31,5	21,5	19,0	05302-02

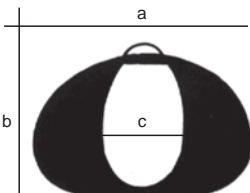

Nr.	L (mm)	a (mm)	b (mm)	c (mm)	Lichtträger light guide Portador de luz
05301-06	180	25,0	16,0	12,0 x 18,0	05302-02
05301-07	220	25,0	16,0	12,0 x 18,0	05302-03

Operations-Laryngoskope
Operation Laryngoscope
Laringoscopios operativo

05300-01

Bruststütze für Erwachsene, Set bestehend aus: 05300-03 / 05300-05 / 05300-06
Chest Support for adults, complete consisting of: 05300-03 / 05300-05 / 05300-06
Soporte pectoral para adultos, compuesto de: 05300-03 / 05300-05 / 05300-06

05300-02

Bruststütze für Kinder, Set bestehend aus: 05300-04 / 05300-05 / 05300-06
Chest Support for children, complete consisting of: 05300-04 / 05300-05 / 05300-06
Soporte pectoral para niños, compuesto de: 05300-04 / 05300-05 / 05300-06

05300-05
Gelenk
Joint
Articulacion



05300-03 - 34 cm, 13.4"
Stützstange für Erwachsene
Support rod for adults
soporte para adultos

05300-04 - 24 cm, 9 ½"
Stützstange für Kinder
Support rod for children
soporte para niños

05300-06 Ring
Ring
Anillo

LEWY Bruststütze, für Operations-Laryngoskop
LEWY Chest Support, for Operation Laryngoscope
Soporte pectoral LEWY para laringoscopios operativo

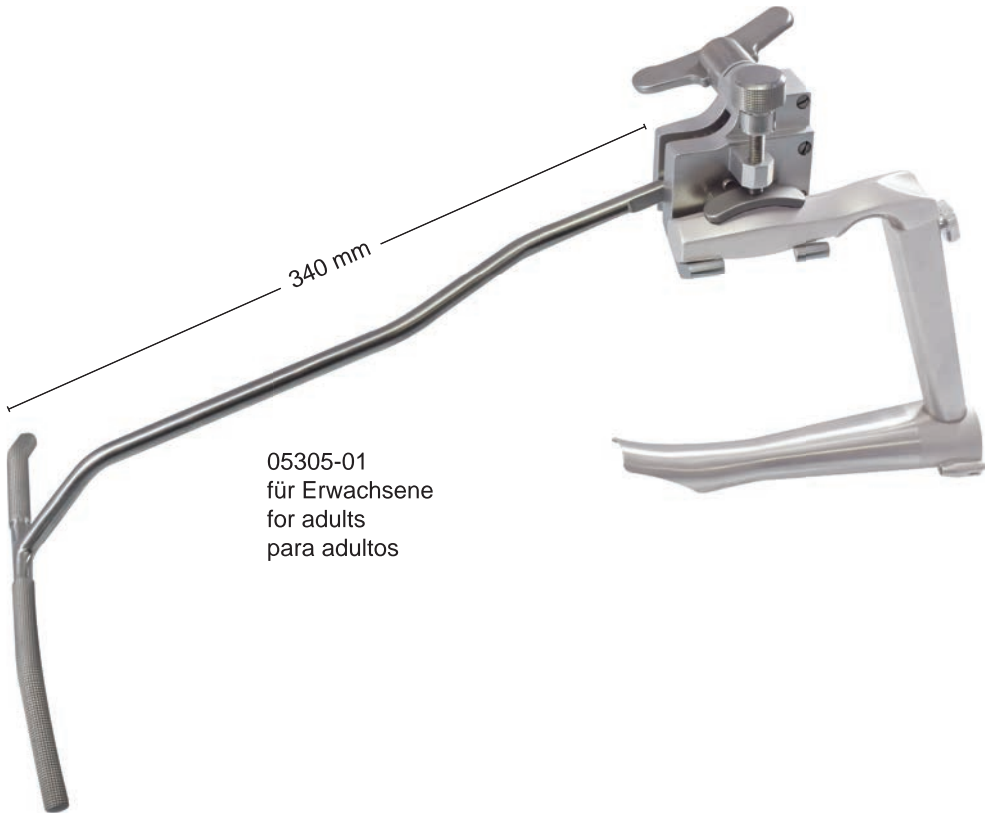

05305-01
für Erwachsene
for adults
para adultos

05305-02
Laryngoskope-Handgriff, abnehmbar
Laryngoscope Handle, detachable
Mango para laringoscopios, desmontable



Verwendung mit
use with
utilizar con

05305-01
LEWY Bruststütze für Operations-Laryngoskope
LEWY Chest Support for Operating Laryngoscope
Soporte pectoral LEWY para laringoscopios operativo

Fiberglas Lichtträger
Fiberglass Light Carriers
Portador de luz fría

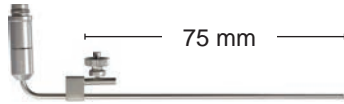

05302-01 for Laryngoskope
05301-01 - 05301-02

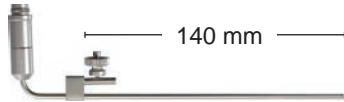

05302-02 for Laryngoskope
05301-03 - 05301-06

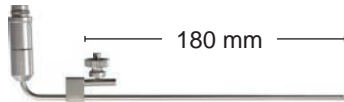

05302-03 for Laryngoskope
05301-07

05303-01

Injektionskanüle für Laryngoskope: 05301-01 - 05301-07

Injection drain tube for Laryngoscopes: 05301-01 - 05301-07

Canúla de inyección para laringoscopios: 05301-01 - 05301-07



ACMI



WOLF



STORZ

Unsere Fiberglas-Lichtträger werden mit allen Adaptern geliefert.
Our Fiberglass light carriers are supplied with all adapters.
Todos nuestros portadores de luz de fibra optica se suministran
con todos los adaptadores.

Fiberglas Lichtträger
Fiberglass Light Carriers
Portador de luz fría



05303-10
Leuchtklammer
Light Clip
Grapa para iluminación

- 05304-01
Rauchabsaugrohr für Laryngoskope: 05301-03 - 05301-07
Suction tube for Laryngoscopes: 05301-03 - 05301-07
Canúla de succión para laringoscopios: 05301-03 - 05301-07

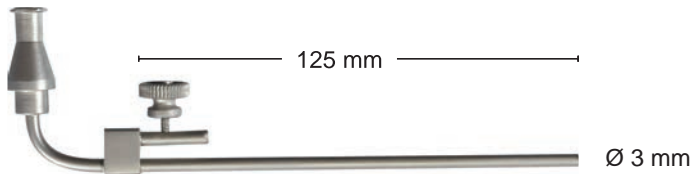

- 05304-02
Rauchabsaugrohr für Laryngoskope: 05301-01 - 05301-02
Suction tube for Laryngoscopes: 05301-01 - 05301-02
Canúla de succión para laringoscopios: 05301-01 - 05301-02

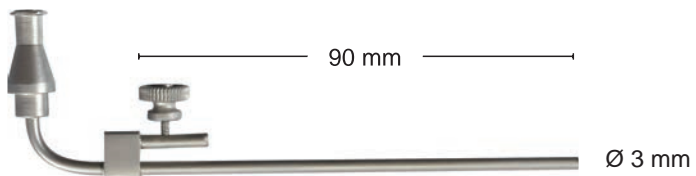

Unsere Fiberglas-Lichtträger werden mit allen Adaptern geliefert.
Our Fiberglass light carriers are supplied with all adapters.
Todos nuestros portadores de luz de fibra optica se suministran con todos los adaptadores.

Laryngoskope mit Fiberglass-Lichtträger
 Laryngoscopes with Fiberglass Light Carrier
 Laringoscopios con portador de luz de fibra óptica

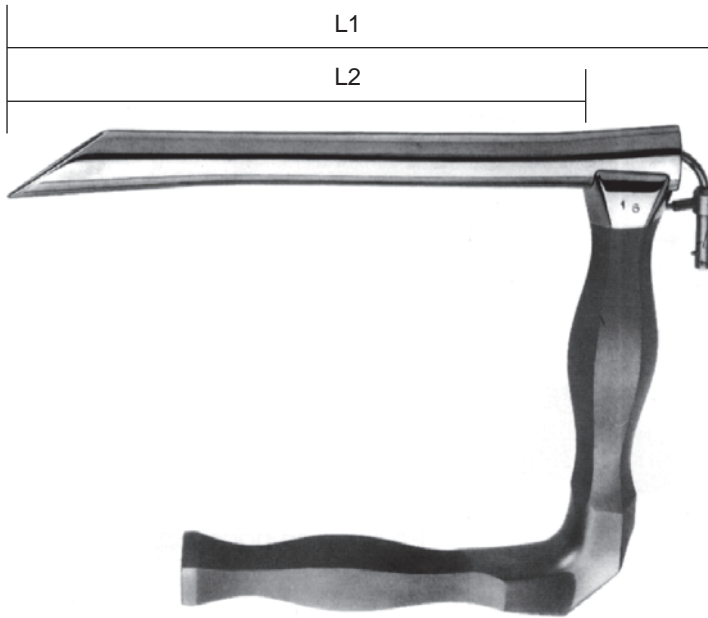

HOLINGER

Nr.	L1	L2	Lichtträger light guide Portador de luz
05310-01	180 mm	158 mm	05311-01
05310-02	170 mm	148 mm	05311-02
05310-03	120 mm	98 mm	05311-03
05310-04	90 mm	68 mm	05311-04



Unsere Fiberglass-Lichtträger werden mit allen Adaptern geliefert.
 Our Fiberglass light carriers are supplied with all adapters.
 Todos nuestros portadores de luz de fibra optica se suministran
 con todos los adaptadores.

Operations-Laryngoskope
 Operation Laryngoscopes
 Laringoscopios operativos



JACKSON

Nr.	L1	L2	Außen-Dm Outer-dm dm-exterior	Innen-Dm Inner-dm dm-interior	Lichtträger light guide Portador de luz
05320-01	180 mm	158 mm	17,0 mm	14,5 mm	05321-01
05320-02	170 mm	148 mm	14,5 mm	12,5 mm	05321-02
05320-03	120 mm	98 mm	14,0 mm	12,0 mm	05321-03
05320-04	90 mm	68 mm	13,0 mm	10,5 mm	05321-04



Unsere Fiberglas-Lichtträger werden mit allen Adaptern geliefert.
 Our Fiberglass light carriers are supplied with all adapters.
 Todos nuestros portadores de luz de fibra optica se suministran
 con todos los adaptadores.



spreizbar
 spreadable
 desplegable

Nr.	L (mm)	a (mm)	b (mm)	c (mm)	Lichtträger light guide Portador de luz
05322-01	130	19,5	12,0	10,5	05302-01
05322-02	150	20,5	13,0	10,5	05302-01
05322-03	170	26,0	15,5	13,5	05302-02
05322-04	170	28,5	18,5	15,0	05302-02
05322-05	170	31,5	21,5	19,0	05302-02
05322-06	180	25,0	16,0	12,0 x 18,0	05302-02
05322-07	220	25,0	16,0	12,0 x 18,0	05302-03



05303-10
 Leuchtklammer
 Light Clip
 Grapa para iluminación

Kehlkopf Polypenzangen
Laryngeal Polypus Forceps
Pinzas para pólipos laringeales

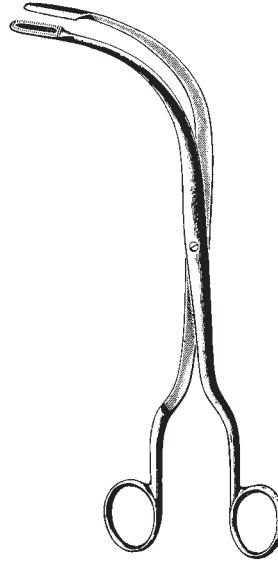

FRAENKEL
53111-18
18 cm, 7"

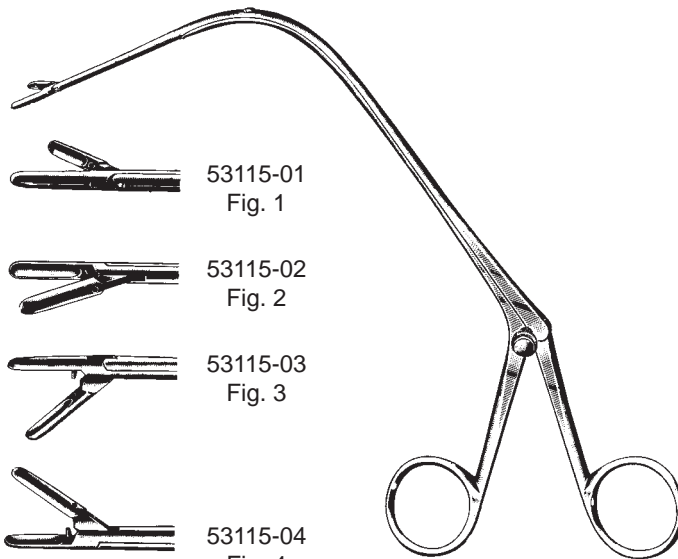

- 53115-01
Fig. 1
- 53115-02
Fig. 2
- 53115-03
Fig. 3
- 53115-04
Fig. 4

JURASZ
23 cm, 9"

Kehlkopfschere, Kehlkopfpinzette, Kehldeckelhalter
Laryngeal Scissors, Laryngeal Forceps, Epiglottis Retractor
Tijera laringeal, Pinza laringeal, Depresor para epiglottis



KILLIAN
53102-20
20 cm, 8"

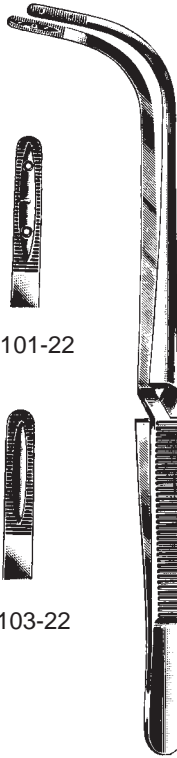

JACKSON
22 cm, 8 ¾"



REICHERT
53121-24
24 cm, 9 ½"

Kehlkopfkanülen, Tonsillenspritzen
Laryngeal Cannulas, Tonsil Syringes
Cánulas laringeales, Jeringas



51291-00
2,5 mm Ø

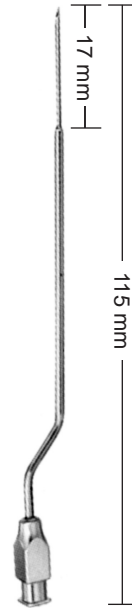

51293-00
0,8 mm Ø

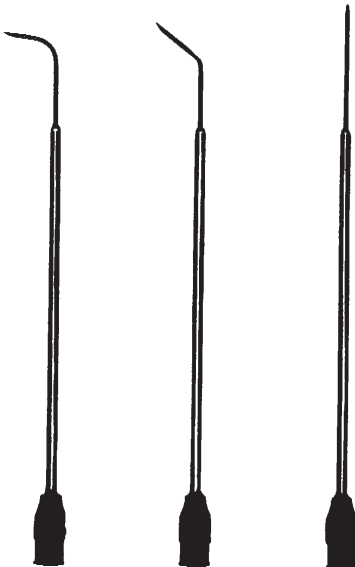

51293-90
90°

51293-45
45°

51292-00

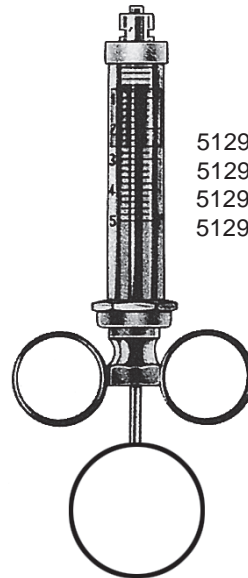

51290-02 2 ml
51290-05 5 ml
51290-10 10 ml
51290-20 20 ml

Kehlkopfspiegel
Laryngeal Mirrors
Espejos laringeales

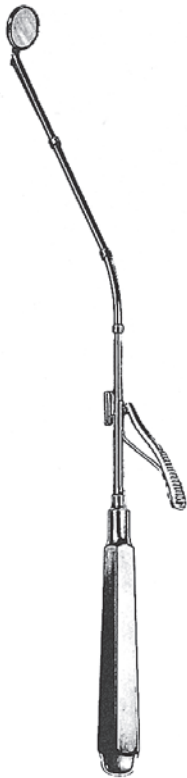

MICHEL
25 cm, 10"



47139-12
12 mm



47139-14
14 mm



47139-16
16 mm



47139-18
18 mm

Kehlkopfspiegel und -griffe
 Laryngeal Mirrors and Handles
 Espejos y mangos laringeales

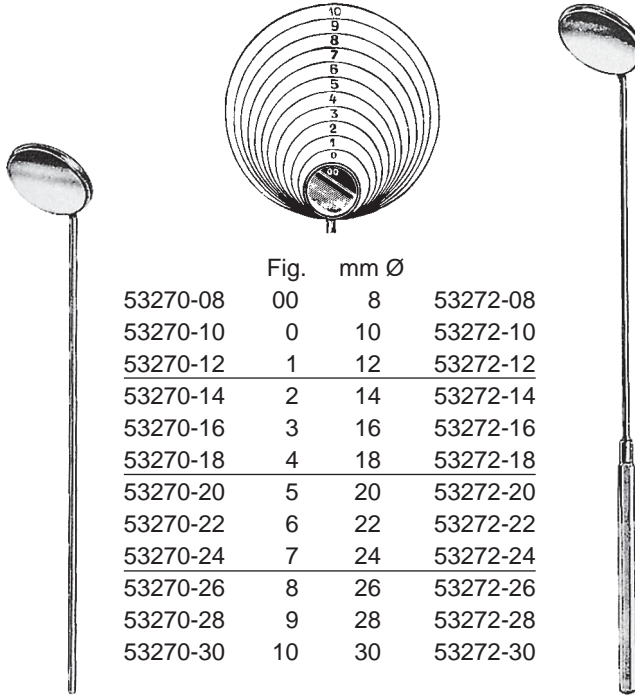

	Fig.	mm Ø	
53270-08	00	8	53272-08
53270-10	0	10	53272-10
53270-12	1	12	53272-12
53270-14	2	14	53272-14
53270-16	3	16	53272-16
53270-18	4	18	53272-18
53270-20	5	20	53272-20
53270-22	6	22	53272-22
53270-24	7	24	53272-24
53270-26	8	26	53272-26
53270-28	9	28	53272-28
53270-30	10	30	53272-30

53270-08 - 53270-30

53272-08 - 53272-30



53274-12



53276-10

Kehlkopfwatteträger
Laryngeal Cotton Carriers
Porta-algodones laringeales

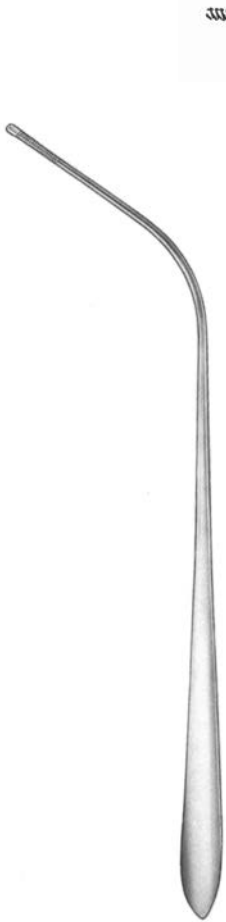

KILLIAN
21350-25
25 cm, 10"

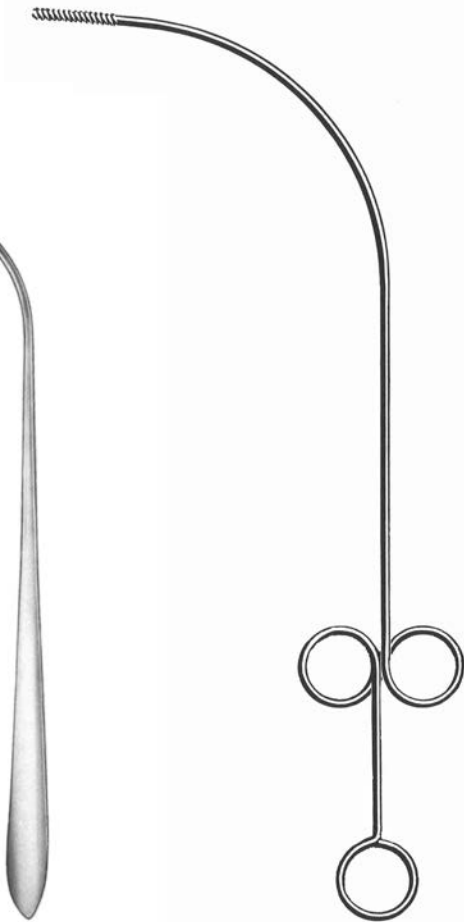

FEIN
21360-26
26 cm, 10 ¼"



21370-25
Ø 2,5 mm

Saugrohre
Suction Tubes
Tubos de aspiración

Koagulations-Saugrohr, gerade
Coagulation Suction Tube, straight
Tubo de succión y coagulación, recto

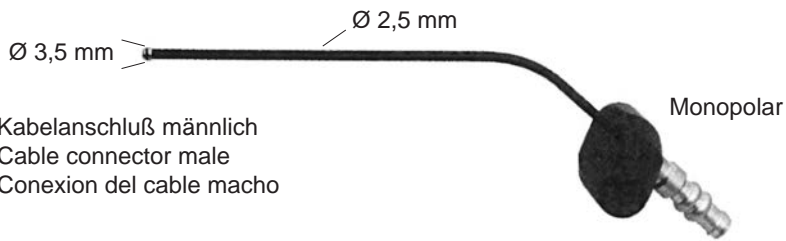

41312-10 Nutzlänge 10 cm, 4"
Working length 10 cm, 4"
Largo útil 10 cm, 4"

41312-26 Nutzlänge 26 cm, 10 ¼"
Working length 26 cm, 10 ¼"
Largo útil 26 cm, 10 ¼"

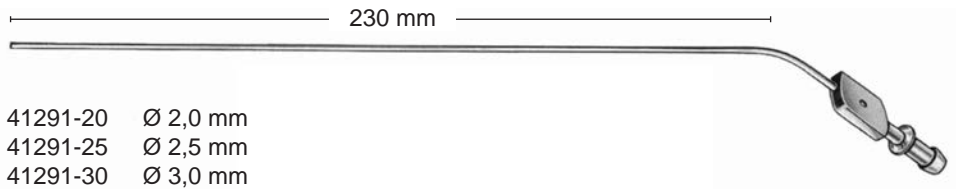

41291-20 $\varnothing 2,0 \text{ mm}$
41291-25 $\varnothing 2,5 \text{ mm}$
41291-30 $\varnothing 3,0 \text{ mm}$



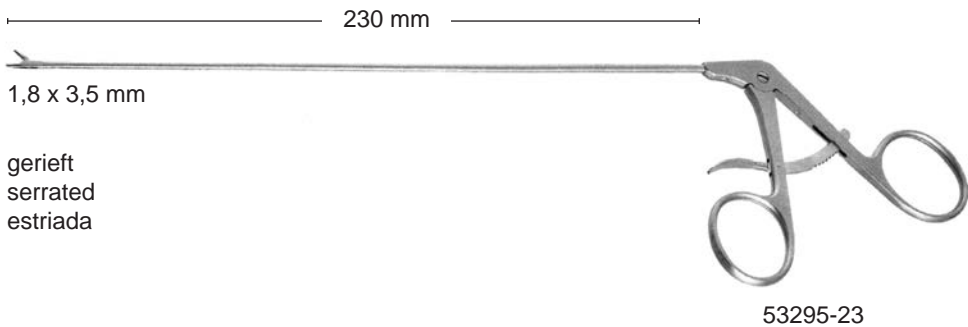
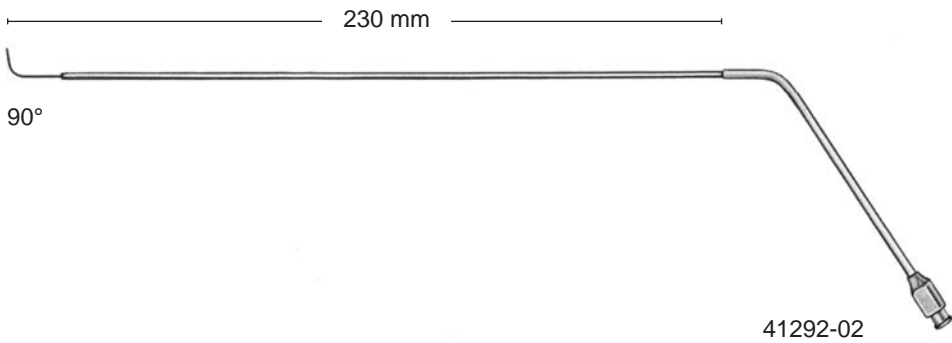
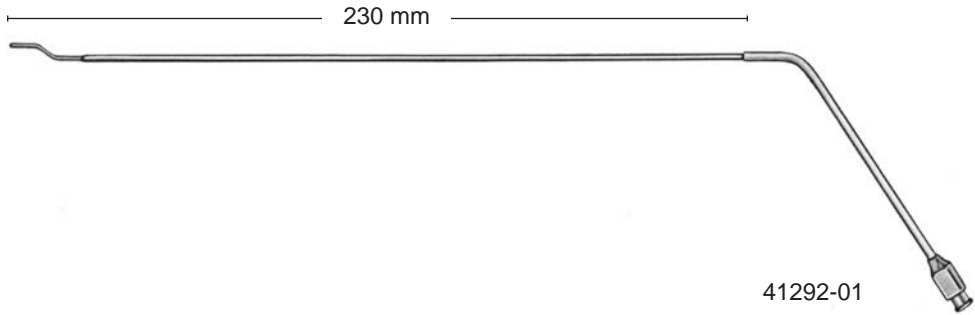

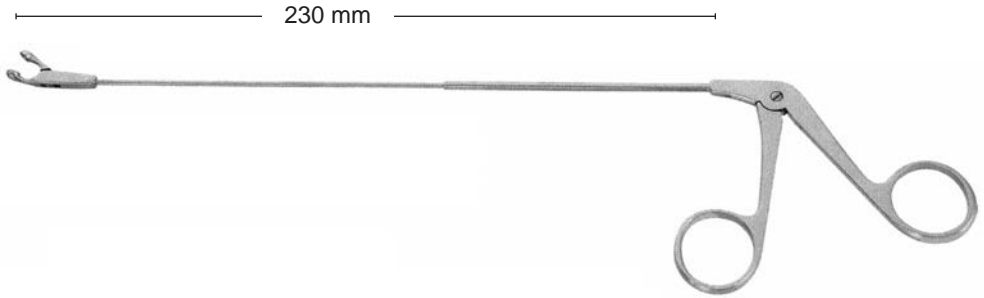

Injektionskanüle, Luer-Lock, Nadelhalter
Injection Needle, Luer-Lock, Needle Holder
Canula de inyeccion, conexion Luer-Lock, Porta-aguja



Mikro Rohrschaftzangen
 Micro Laryngeal Forceps
 Micro pinzas con vaina tubular







Mikro-Fasszängchen
 Micro Grasping Forceps
 Micro pinzas de agarre





	gerade, gerieft straight, serrated recta, estriada	53280-01 1,5 x 10 mm
	nach links gebogen, gerieft curved to left, serrated curvada hacia la izquierda, estriada	53280-02 1,5 x 8,5 mm
	nach rechts gebogen, gerieft curved to right, serrated curvada hacia la derecha, estriada	53280-03 1,5 x 8,5 mm
	aufgebogen, gerieft curved up, serrated curvada hacia arriba, estriada	53280-16
	dreieckig, gerieft, nach rechts aufgebogen triangular, serrated, curved to right triangulada, estriada, curvada hacia la derecha	53280-17
	dreieckig, gerieft, nach links aufgebogen triangular, serrated, curved to left triangulada, estriada, curvada hacia la izquierda	53280-18

Mikro Rohrschaftzangen
 Micro Laryngeal Forceps
 Micro pinzas con vaina tubular

Mikro-Löffelzangen
 Micro Cup Shaped Forceps
 Micro pinzas en forma cucharilla

		Ø 2 mm	Ø 4 mm
	gerade straight recta	53280-04	53280-19
	nach links gebogen curved to left curvada hacia la izquierda	53280-05	53280-20
	nach rechts gebogen curved to right curvada hacia la derecha	53280-06	53280-21
	aufgebogen curved up curvada hacia arriba	53280-07	53280-22

Mikro-Scheren
 Micro Scissors
 Micro tijeras

	gerade straight recta		53280-08
	nach links gebogen curved to left curvada hacia la izquierda		53280-09
	nach rechts gebogen curved to right curvada hacia la derecha		53280-10
	gerade horizontal straight horizontal recta horizontal		53280-11
	aufgebogen 45° curved up 45° curvada hacia arriba en 45°		53280-12

Instrumente für Laryngoskopie
 Instruments for Laryngology
 Instrumentos para laringoscopia

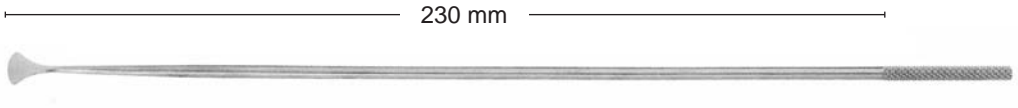



	Messer, sichelförmig, gebogen, spitz Knife, sickle shaped, curved, pointed Cuchillo en forma de hoz, agudo, curvo	53290-01
---	---	----------

	Messer, oval, gerade Knife, oval, straight Cuchillo, recto, ovalado	53290-02
---	---	----------

	Messer, Rundschnittform, vertikal schneidend Knife, round, cuts vertically Cuchillo, corte redondo, corte vertical	53290-03
---	--	----------

	Messer, oval 45°, 2,5mm Knife, oval 45°, 2,5 mm Cuchillo, ovalado en 45°, 2,5mm	53290-04
---	---	----------





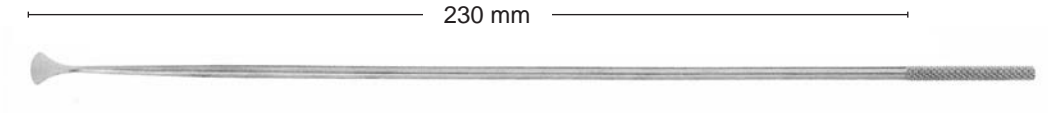

	Häkchen, stumpf 90°, mit Sondenknopf Hook, blunt angled 90° with probe end Ganchito, romo en 90°, abotonado	53290-05
---	---	----------

	Häkchen, stumpf, mit Sondenknopf Hook, blunt with probe end Ganchito, romo, abotonado	53290-06
---	---	----------

	Knotenführer Knot tier Baja nudos	53290-07
---	---	----------

Instrumente für Laryngoskopie
 Instruments for Laryngology
 Instrumentos para laringoscopia



	Messer, gerader Schnitt, spitz Knife, straight cut, pointed Cuchillo, corte recto, agudo	53290-11
	Messer, golfstockförmig, gebogen, rund Knife, golf stick shaped, curved round Cuchillo en forma de golf, curvo, redondo	53290-12
	Häkchen, scharf Hook, sharp Ganchito, agudo	53290-13
	Umstechungsnadel, nach links gebogen Needle, curved to left Aguja, curvada hacia la izquierda	53290-14
	Umstechungsnadel, nach rechts gebogen Needle, curved to right Aguja, curvada hacia la derecha	53290-15
	Saugraspatorium Suction Elevator Legra de succion	53290-16



53290-08
 Handgriff für Stabinstrumente
 Handle for microlaryngeal instruments
 Mango para instrumentos microlaringeos

Universalgriffe, Verlängerungsrohre, Aufsätze
 Universal Handles, Interchangeable Tips, Tubes
 Mangos universales, Tubos de extension, Puntas



BRUENINGS
 53131-20
 20 cm, 8"



BRUENINGS

- | | | | |
|----------|----------------|----------|----------------|
| 53132-20 | 20 cm, 8" | 53132-50 | 50 cm, 19 3/4" |
| 53132-30 | 30 cm, 11 3/4" | 53132-60 | 60 cm, 23 1/2" |
| 53132-40 | 40 cm, 15 3/4" | | |

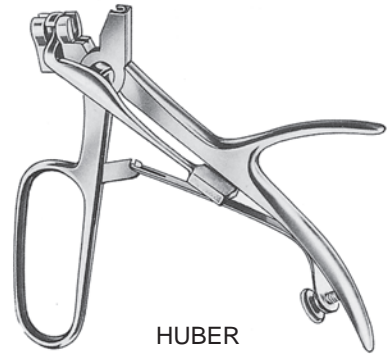

HUBER
 53130-00



FRAENKEL
 53150-00



SEIFERT
 53152-00



FRAENKEL
 53154-00



SCHEINMANN
 53155-00



SCHEINMANN
 53157-00



53158-02



53158-03



BRUENINGS
 53158-02 - 53158-03



53160-02



53160-03



BRUENINGS
 53160-02 - 53160-03



LANGE
 53162-00



53164-01



53164-02



KRAUSE
 53164-01 - 53164-02



KRAUSE
 53166-00



SCHUMACHER
 53170-00



BARACANI
 53175-00



53177-01



53177-02

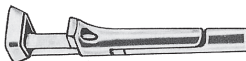

CORDES
 53177-01 - 53177-02



Reda Instrumente GmbH
Gänsäcker 34 - P.O. Box 131
D-78532 Tuttlingen

BRONCHOSKOPIE

BRONCHOSCOPY

BRONCOSCOPIA



www.Red-Instrumente.de





Indikationen und Kontraindikationen finden Sie in der entsprechenden Gebrauchsanweisung!



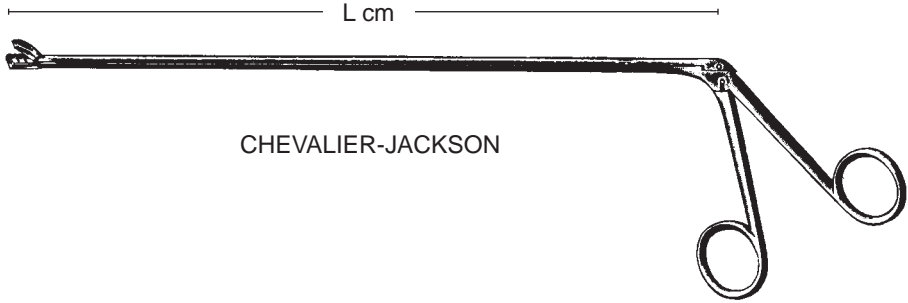

Indication and Contraindication please refer to our user's manual!

Indicaciones y Contraindicaciones se encuentran en la instrucciones de uso correspondientes!

Broncho-Oesophagoskopiezangen
 Broncho-Esophagoscopy Forceps
 Pinzas para bronco-esofagoscopia



				Ø 4 mm
				
	Fig. 1	Fig. 2	Fig. 3	Fig. 4
30 cm / 11 3/4"	53230-01	53230-02	53230-03	53230-04
40 cm / 15 3/4"	53240-01	53240-02	53240-03	53240-04
50 cm / 19 3/4"	53250-01	53250-02	53250-03	53250-04
60 cm / 23 1/2"	53260-01	53260-02	53260-03	53260-04

				
	Fig. 5	Fig. 6	Fig. 7	Fig. 8
30 cm / 11 3/4"	53230-05	53230-06	53230-07	53230-08
40 cm / 15 3/4"	53240-05	53240-06	53240-07	53240-08
50 cm / 19 3/4"	53250-05	53250-06	53250-07	53250-08
60 cm / 23 1/2"	53260-05	53260-06	53260-07	53260-08

Reda Instrumente GmbH
Gänsäcker 34 - P.O. Box 131
D-78532 Tuttlingen



SÄTZE

SET

SET



www.Reda-Instrumente.de

Indikationen und Kontraindikationen finden Sie in der entsprechenden Gebrauchsanweisung!
Indication and Contraindication please refer to our user`s manual!
Indicaciones y Contraindicaciones se encuentran en la instrucciones de uso correspondientes!

SET/440:	Grundsieb HNO / Basic set for ENT / Juego basico para ORL	
03180-90	ZIEGLER head mirror 90mm	1x1
45246-14	ear forceps, HARTMANN 14cm	1x1
45206-14	ear forceps bayonet, LUCAE 14cm, without teeth	1x1
65110-15	tissue forceps, ALLIS 4x5 teeth, 15cm	1x1
17170-25	swab forceps serrated,FOERSTER straight, 25cm	1x1
45010-00	ear specula set of 4, HARTMANN	1x1
09304-14	operating sciss.fine, JOSEPH straight, 14,0cm	1x1
09305-14	operating sciss.fine, JOSEPH curved, 14,5cm	1x1
25137-11	BABY WEBSTER Needle Holder 4 3/4 TC smooth	1x1
45110-00	ear curette, BUCK straight, blunt, Fig. 0	1x1
45110-01	ear curette, BUCK straight, blunt, Fig. 1	1x1
45097-10	ear syringe complete, REINER 100ml	1x1
45150-18	paracentesis needle, POLITZER bajonet, 18cm	1x1
41299-03	Suction Tube Baron 3Fr	1x1
41299-05	suction tubes Baron 5Fr.	1x1
41299-07	suction tube, BARON 7 Fr.	1x1
45180-02	ear loop, BILLEAU, Fig.2, 16cm	1x1
45190-01	ear hooklet small, DAY, Fig. 1, 16cm	1x1
47112-01	nasal speculum, MOD.VIENNA for babies	1x1
47112-02	nasal speculum, MOD.VIENNA for children	1x1
47112-03	nasal speculum, MOD.VIENNA for adults	1x1
49107-19	tongue depressor, BRUENINGS 19cm	2x1
49265-14	mouth gag, DOYEN-JANSEN (Molt) 14cm	1x1
45072-01	Tuning forks w. foot, A1-440	1x1
21272-14	cotton applicators, FARREL triangular, 14cm	1x1
45193-01	hooklet , LUCAE Fig. 1	1x1
45206-16	ear forceps bayonet, LUCAE without teeth, 16cm	1x1
45261-08	ear polypus forceps, HARTMANN 8,5cm	1x1
45271-08	ear forceps, STRUEMPEL D. 2,5 x 5mm, 8,5cm	1x1
11102-14	forceps dressing, 14,5cm	1x1
11120-14	forceps tissue 1x2 t. 14,5 cm	1x1
47351-26	nasal snare angled, KRAUSE 26cm	1x1
47355-03	loops 0,3 mm bundle of 12 ea.	1x1
47332-25	EICKEN (KILLIAN) antrum cannula 2.5mm	1x1
43614-00	BOWMAN lachrymal probe, Fig. 00/0, 0,7/0,8mm Ø	1x1
43614-12	BOWMAN lachrymal probe, Fig. 1/2, D. 0,9/1,1mm	1x1
07103-00	scalpel handle no. 3 12,5cm	1x1
89142-02	jar 50 x 100mm	1x1
53272-10	laryngeal mirror with handle Fig. 0, D. 10mm	5x1
53272-12	laryngeal mirror with handle Fig. 1, D. 12mm	5x1
53272-16	laryngeal mirror with handle Fig. 3, D. 16mm	3x1
53272-18	laryngeal mirror with handle Fig. 4, D. 18mm	3x1
51290-02	tonsil syringe 3 rings LL 2ml	1x1
51292-00	tonsil injection needle straight	1x1
45097-10	ear syringe complete, REINER 100ml	1x1
89139-25	Kidney bowl medium 250 x 140 x 40mm	1x1

**SET/443: Myringotomie Set / Myringotomie Set /
Juego para miringotomia**

45010-55	ear specula, HARTMANN D. 5,5mm	1x1
45010-65	ear specula, HARTMANN D. 6,5mm	1x1
45010-75	ear specula, HARTMANN D. 7,5mm	1x1
45350-70	ear forceps micro serrated 7mm x 8cm	1x1
45110-01	ear curette, BUCK straight, blunt, Fig. 1	1x1
45165-17	ear knife, SEXTON angled, 17cm	1x1
45151-16	paracentesis needle, POLITZER angled, 16,5cm	1x1
45713-15	needle, BARBARA curved pointed	1x1
45724-10	hooklet, BARBARA 90° angled, 1,0mm	1x1
45180-02	ear loop, BILLEAU, Fig.2, 16cm	1x1
45192-02	hooklet , WAGENER Fig. 2, 14cm	1x1
21272-14	cotton applicators, FARREL triangular, 14cm	1x1
41305-07	suction tubes, ROSEN D. 0,7mm	1x1
41305-09	suction tubes, ROSEN D. 0,9mm	1x1
41305-12	suction tubes, ROSEN D. 1,2mm	1x1
41307-00	WULLSTEIN suction handle for Rosen cann.	1x1
45206-14	ear forceps bayonet, LUCAE 14cm, without teeth	1x1
45246-12	ear forceps, HARTMANN, 12cm	1x1
45255-08	ear polypus forceps, WULLSTEIN 8,5cm	1x1

SET/441: Set für Mastoidektomie / Mastoidectomy Set / Juego para mastoidectomia

07103-00	scalpel handle no. 3 12,5cm	1x1
47102-02	nasal speculum, HARTMANN-HALLE Fig. 2	1x1
19670-16	retractor, WEITLANER sharp, 16,5cm	1x1
19670-14	retractor, WEITLANER sharp, 14,0cm	1x1
19654-13	retractor, WEITLANER-WULLSTEIN sharp, 13cm	1x1
19280-03	retractor, VOLKMANN pointed, 21,5cm, 3 teeth	2x1
19312-02	retractor, LANGENBECK 21cm, 30x14mm	2x1
33702-15	periosteal elevator, FARABEUF straight, 15cm, 12,5mm	1x1
45807-20	elevator, LEMPERT 20.5cm	1x1
47415-18	FREER septum elevator, 18cm double ended, sharp/blunt	1x1
33605-04	gouge 13,5cm, 4mm	1x1
33605-06	gouge 13.5cm x 6mm	1x1
33605-08	gouge 13,5cm, 8mm	1x1
33602-04	osteotome 13,5cm, 4mm	1x1
33602-06	osteotome 13,5cm, 6mm	1x1
33602-08	osteotome 13,5cm, 8mm	1x1
33700-05	hammer, COTTLE flat/convex D. 30mm, 240gr., 18cm	1x1
47303-03	punch, KERRISON 17cm, shaft 85mm, 3x3mm	1x1
33156-18	bone rongeur, BEYER 18cm	1x1
45760-01	curette, HOUSE 1,0 / 1,2mm	1x1
33490-20	bone curette, LEMPERT 17,5cm, Fig. 00	1x1
33475-00	bone curette, SPRATT 17cm, Fig. 0	1x1
33475-01	bone curette, SPRATT 17cm, Fig. 1	1x1
13221-12	hemost.fcps.,HALSTED-MOSQUITO curved, 12,0cm	4x1
13310-14	hemost.fcps. ,ROCHESTER-PEAN straight, 14cm	4x1
13311-14	hemost.fcps. ,ROCHESTER-PEAN curved,14cm	4x1
13320-14	hemost.fcps.,ROCHESTER-OCHSNER 1x2 teeth, straight, 14cm	2x1
65110-15	tissue forceps, ALLIS 4x5 teeth, 15cm	2x1
11170-12	forceps dressing serr., ADSON 12cm	1x1
11180-12	forceps tissue 1x2 t.,ADSON 12cm	1x1
11188-12	forceps tissue, ADSON-BROWN 7x7 teeth, 12cm	1x1
11102-14	forceps dressing, 14,5cm	1x1
11120-14	forceps tissue 1x2 t. 14,5 cm	1x1
21320-18	cotton applicator,JOBSON-HORNE 18cm	1x1
09341-10	operating sciss.fine, IRIS curved, 10cm	1x1
09363-11	scissors, STEVENS blunt/blunt, curved 11cm	1x1
09305-14	operating sciss.fine, JOSEPH curved, 14,5cm	1x1
09283-15	diss.scissors,METZENBAUM-FINO curved, 15cm	1x1
09110-14	operating scissors, STANDARD pointed/blunt, straight 14,5cm	1x1
41299-03	Suction Tube Baron 3Fr	1x1
41299-05	suction tubes Baron 5Fr.	1x1
41299-07	suction tube, BARON 7 Fr.	1x1
41295-06	suction tube, FRAZIER/FERGUSSON 19cm, 30°, Charr. 6	1x1
41295-08	suction tube, FRAZIER/FERGUSSON 19cm, 30°, Charr. 8	1x1
41295-10	suction tube, FRAZIER/FERGUSSON 19cm, 30°, Charr. 10	1x1
41307-00	WULLSTEIN suction handle for Rosen cann.	1x1
41305-05	suction tubes, ROSEN D. 0,5mm	2x1

41305-08	Rosen Suction Tube 0,8mm	2x1
41305-09	suction tubes, ROSEN D. 0,9mm	2x1
41305-12	suction tubes, ROSEN D. 1,2mm	2x1
25144-13	needle holder, HALSEY serrated, TC, 13cm	1x1
25164-15	needle holder, CRILE-WOOD serrated, TC, 15cm	1x1
15111-09	towel forceps, BACKHAUS 9cm	6x1
17110-20	dressing forceps, GROSS-MAIER straight, 20cm	1x1
89127-08	Bowl round, stainless steel 80 x 40mm, 0,14 l. (5,6 OZ)	1x1
89127-06	round bowl 61x30mm, 0.07 ltr	1x1

SET/442: Set für Mikrochirurgie (Ohr) / Set for Ear Micro Surgery / Juego para micro otologia

47103-03	nasal specula HARTMANN Fig. 3	1x1
45803-16	elevator, LEMPERT curved, 16cm, 2mm	1x1
33718-16	periosteal elevator, JOSEPH 16cm, 4mm	1x1
11120-11	forceps tissue 1x2 t. 11,5 cm	1x1
11260-15	forceps dressing, SEMKEN 15,5cm	1x1
09141-14	dissecting scissors, DEEVER pointed/blunt, curved, 14,5cm	1x1
19677-13	Plester retractor, 13cm 2x2t., sharp	2x1
19673-11	retractor, PLESTER blunt, 11cm	1x1
19672-11	retractor, PLESTER blunt, 11cm	1x1
19283-01	WILLIGER, wound retractor, 12cm 3 teeth, sharp, straight	1x1
07103-00	scalpel handle no. 3 12,5cm	2x1
09111-14	operating scissors, STANDARD pointed/blunt, curved, 14,5cm	1x1
13310-14	hemost.fcps., ROCHESTER-PEAN straight, 14cm	1x1
25129-13	needle holder, WEBSTER TC smooth, 13cm	1x1
13220-12	hemost.fcps., HALSTED-MOSQUITO straight, 12,5cm	1x1
13221-12	hemost.fcps., HALSTED-MOSQUITO curved, 12,0cm	2x1
15111-09	towel forceps, BACKHAUS 9cm	6x1
09340-10	operating sciss.fine, IRIS straight, 10cm	1x1
R065-040125-003	Bipolar connecting cable 3 mtr. long for Erbe / Storz HF-generators european flat plug f. instruments	1x1
45010-55	ear specula, HARTMANN D. 5,5mm	1x1
45010-65	ear specula, HARTMANN D. 6,5mm	1x1
45010-75	ear specula, HARTMANN D. 7,5mm	1x1
45350-70	ear forceps micro serrated 7mm x 8cm	1x1
45255-08	ear polypus forceps, WULLSTEIN 8,5cm	1x1
45261-08	ear polypus forceps, HARTMANN 8,5cm	1x1
45362-45	ear fcps.micro spoon oval 4,5mm, straight	1x1
45267-20	ear polypus forceps, HARTMANN D. 2,0mm, 8,5cm	1x1
45310-40	ear scissors micro, BELLUCCI micro mini, 4mm	1x1
45387-01	DIETER, malleurs punches upwards cutting, Ø 1,8mm, 8cm	1x1
45371-40	McGEE, wire bending forceps 0,8 x 4,0mm, 8cm	1x1
41305-10	suction tubes, ROSEN D. 1,0mm	4x1
41305-07	suction tubes, ROSEN D. 0,7mm	4x1
41305-12	suction tubes, ROSEN D. 1,2mm	4x1
41305-15	suction tubes, ROSEN D. 1,5mm	4x1
41305-20	suction tubes, ROSEN D. 2,0mm	4x1
41307-00	WULLSTEIN suction handle for Rosen cann.	1x1
41304-06	suction tubes, PLESTER 30°, Charr.6	1x1
41304-08	suction tubes, PLESTER 30°, Charr.8	1x1
41304-10	suction tubes, PLESTER 30°, Charr.10	1x1
45190-02	ear hooklet medium, DAY, Fig. 2, 16cm	1x1
45192-03	hooklet, WAGENER Fig. 3, 14cm	1x1
45111-00	ear curette Buck straight, sharp, Fig. 00	1x1
45112-00	ear curette Buck straight, sharp, Fig. 0	1x1
45748-16	hook, reverse cutting, 0,6mm/16cm	1x1
45760-01	curette, HOUSE 1,0 / 1,2mm	2x1

45760-02	curette, HOUSE 1,5 / 1,8mm	2x1
45749-16	PLESTER, footplate hook, 16cm 90°angled, oval-blunt	1x1
45722-06	hooklet, BARBARA 45° angled, 0,6mm	1x1
45724-03	hooklet, BARBARA 90° angled, 0,3mm	2x1
45724-06	hooklet, BARBARA 90° angled, 0,6mm	2x1
45771-16	fork PLESTER, 16cm, width 0,6mm	1x1
45722-10	hooklet, BARBARA 45° angled, 1,0mm	1x1
45706-35	Round knife, PLESTER 15,5cm, size 3,5mm	2x1
45709-20	knife circular, ROSEN 2mm	2x1
45704-15	sickle knife, WULLSTEIN 15,5cm	2x1
45713-15	needle, BARBARA curved pointed	2x1
45724-10	hooklet, BARBARA 90° angled, 1,0mm	1x1
91127-16	bipolar forceps angled 1mm, 16,5cm	1x1
89127-08	Bowl round, stainless steel 80 x 40mm, 0,14 l. (5,6 OZ)	1x1

**SET/444: Set für Ohrmuschel - Operation /
Set for Otoplasty Surgery / Juego para cirugía otoplastica**

07103-00	scalpel handle no. 3 12,5cm	1x1
09341-10	operating sciss.fine, IRIS curved, 10cm	1x1
09305-14	operating sciss.fine, JOSEPH curved, 14,5cm	1x1
09358-11	Cottle bulldog-scissors cvd.,11,5cm	1x1
09111-14	operating scissors, STANDARD pointed/blunt, curved, 14,5cm	1x1
11130-11	Tissue Fcps 1x2 teeth 11cm fine	1x1
11188-12	forceps tissue, ADSON-BROWN 7x7 teeth, 12cm	1x1
11102-14	forceps dressing, 14,5cm	1x1
11120-14	forceps tissue 1x2 t. 14,5 cm	1x1
21272-14	cotton applicators, FARREL triangular, 14cm	1x1
47530-01	DINGMAN nasal rasp 15cm, left # 1	1x1
47530-02	DINGMAN nasal rasp 15cm right # 2	1x1
47380-15	nasal plastic knife, COTTLE 15cm	1x1
47415-18	FREER septum elevator, 18cm double ended, sharp/blunt	1x1
47451-04	septum chisel, FREER 4mm, curved	1x1
47562-18	hooklet delicate, GILLIES 18cm Fig. 2	1x1
19216-05	hooklet sharp 2 prong, JOSEPH 5mm, 16cm	1x1
19221-02	retractor (trach.) blunt 2 prongs, 16cm	1x1
89148-25	medicine cup 25 CC	1x1
51290-05	tonsil syringe 3 ring LL 5ml	1x1
41295-10	suction tube, FRAZIER/FERGUSSON 19cm, 30°, Charr. 10	1x1
41295-08	suction tube, FRAZIER/FERGUSSON 19cm, 30°, Charr. 8	1x1
13221-12	hemost.fcps.,HALSTED-MOSQUITO curved, 12,0cm	6x1
13240-14	hemost.fcps. , KELLY straight, 14cm	1x1
11190-10	forceps, GRAEFE 10,5cm	1x1
43810-10	GRAEFE iris forceps, anatomic, straight, 10cm	1x1
13310-14	hemost.fcps. ,ROCHESTER-PEAN straight, 14cm	1x1
15111-09	towel forceps, BACKHAUS 9cm	6x1
25144-13	needle holder, HALSEY serrated, TC, 13cm	1x1
91122-16	bipolar forceps pointed straight, 16,5cm total long	1x1
R065-040125-005	Bipolar connecting cable 5mtr. long for Erbe / Storz HF-generators european plug for instruments	1x1

**SET/445: Satz zur Mittelohr-Chirurgie, Tympanoplastik und Stapedektomie /
Set for tympanic and stapedectomy /
Juego para cirugía de timpano y estapedectomía**

19654-13	retractor, WEITLANER-WULLSTEIN sharp, 13cm	1x1
19672-11	retractor, PLESTER blunt, 11cm	1x1
19673-11	retractor, PLESTER blunt, 11cm	1x1
19677-13	Plester retractor, 13cm 2x2t., sharp	1x1
47120-50	Nasal speculum, KILLIAN 50mm	1x1
45010-55	ear specula, HARTMANN D. 5,5mm	1x1
07103-00	scalpel handle no. 3 12,5cm	1x1
07109-15	scalpel handle MINI 15,5cm	1x1
47451-04	septum chisel, FREER 4mm, curved	1x1
45802-16	elevator, LEMPert straight, 16cm, 2mm	1x1
41305-12	suction tubes, ROSEN D. 1,2mm	1x1
41305-15	suction tubes, ROSEN D. 1,5mm	1x1
41305-20	suction tubes, ROSEN D. 2,0mm	1x1
41307-00	WULLSTEIN suction handle for Rosen cann.	1x1
45709-10	knife circular, ROSEN 1.0mm	1x1
45724-06	hooklet, BARBARA 90° angled, 0,6mm	1x1
45724-10	hooklet, BARBARA 90° angled, 1,0mm	1x1
45724-15	hooklet, BARBARA 90° angled, 1,5mm	1x1
45724-25	hooklet, BARBARA 90° angled, 2,5mm	1x1
45766-40	Micro Measuring Rod, HOUSE 4.0mm	1x1
45766-50	Micro Measuring Rod, HOUSE 5.0mm	1x1
11120-11	forceps tissue 1x2 t. 11,5 cm	1x1
11120-14	forceps tissue 1x2 t. 14,5 cm	1x1
11405-05	forceps, jeweller Fig. 5 11cm, 0.15mm	1x1
11170-12	forceps dressing serr., ADSON 12cm	1x1
09285-12	dissecting sciss., METZENBAUM curved, TC 12,0cm	1x1
09340-10	operating sciss.fine, IRIS straight, 10cm	1x1
09358-11	Cottle bulldog-scissors cvd., 11,5cm	1x1
09111-14	operating scissors, STANDARD pointed/blunt, curved, 14,5cm	1x1
13221-12	hemost.fcps., HALSTED-MOSQUITO curved, 12,0cm	1x1
25164-15	needle holder, CRILE-WOOD serrated, TC, 15cm	1x1
45706-35	Round knife, PLESTER 15,5cm, size 3,5mm	1x1
45722-10	hooklet, BARBARA 45° angled, 1,0mm	1x1
45757-16	dissector, FISCH right, 16cm	1x1
45755-16	dissector, FISCH left, 16cm	1x1
45704-15	sickle knife, WULLSTEIN 15,5cm	1x1
45724-03	hooklet, BARBARA 90° angled, 0,3mm	1x1
45724-06	hooklet, BARBARA 90° angled, 0,6mm	1x1
45724-10	hooklet, BARBARA 90° angled, 1,0mm	1x1
21108-14	probe myrtle leaf 14,5 cm	1x1
45371-40	McGEE, wire bending forceps 0,8 x 4,0mm, 8cm	1x1
45362-45	ear fcps.micro spoon oval 4,5mm, straight	1x1
45267-20	ear polypus forceps, HARTMANN D. 2,0mm, 8,5cm	1x1
45255-08	ear polypus forceps, WULLSTEIN 8,5cm	1x1
45310-40	ear scissors micro, BELLUCCI micro mini, 4mm	1x1
45315-55	ear scissors micro, BELLUCCI micro stanard, 5,5mm, curved right	1x1
45317-55	ear scissors micro, BELLUCCI micro standard, 5,5mm, curved left	1x1
45324-03	FISCH, ear scissors, cvd. right 3,0x0,75x2,0mm, 8cm	1x1
45325-03	FISCH, ear scissors, cvd. left 3,0x0,75x2,0mm, 8cm	1x1

**SET/450: Nasenseptumsatz / Nasal Septum set /
Juego para el septo nasal**

47102-03	nasal speculum, HARTMANN-HALLE Fig. 3	1x1
47120-50	Nasal speculum, KILLIAN 50mm	1x1
47120-75	nasal speculum, KILLIAN 75mm	1x1
47120-90	nasal speculum, KILLIAN 90mm	1x1
09341-11	operating sciss.fine, IRIS curved, 11cm	1x1
09305-14	operating sciss.fine, JOSEPH curved, 14,5cm	1x1
09350-10	Graefe scissors, 10cm fine pattern	1x1
47223-01	WEIL-BLAKESLEY nose forceps shaft 120mm, straight, 3.0mm, Fig.1	1x1
47242-00	nasal cutting fcps, TAKAHASHI shaft 120mm, 4x10mm tip, straight	1x1
09401-18	scissors nasal, HEYMANN 18cm	1x1
47159-20	LUBET-BARBON nasal dressing forceps, 20cm	1x1
41295-08	suction tube, FRAZIER/FERGUSSON 19cm, 30°, Charr. 8	1x1
49107-19	tongue depressor, BRUENINGS 19cm	1x1
47565-10	COTTLE columella forcep 10cm	1x1
11188-12	forceps tissue, ADSON-BROWN 7x7 teeth, 12cm	1x1
11190-10	forceps, GRAEFE 10,5cm	1x1
11102-14	forceps dressing, 14,5cm	1x1
11120-14	forceps tissue 1x2 t. 14,5 cm	1x1
45206-16	ear forceps bayonet, LUCAE without teeth, 16cm	1x1
21270-14	cotton applicators, FARREL threaded, 14cm	2x1
47380-15	nasal plastic knife, COTTLE 15cm	1x1
47554-01	retractor, COTTLE Fig. 1 14.5cm	1x1
47410-04	septum elevator, McKENTY 15cm, 4mm	1x1
33700-05	hammer, COTTLE flat/convex D. 30mm, 240gr., 18cm	1x1
47415-18	FREER septum elevator, 18cm double ended, sharp/blunt	1x1
47454-04	rhinoplastic ostetome, COTTLE 18cm, straight, 4mm	1x1
47454-07	rhinoplastic osteotome, COTTLE 18cm, straight, 7mm	1x1
47423-22	septum elevator, COTTLE 22cm	1x1
25214-18	needle holder, DE-BAKEY serrated, TC, 18cm	1x1
15111-09	towel forceps, BACKHAUS 9cm	6x1
47351-26	nasal snare angled, KRAUSE 26cm	1x1
47355-03	loops 0,3 mm bundle of 12 ea.	1x1
47385-15	nasal plastic knife, JOSEPH 15cm curved	1x1
89127-08	Bowl round, stainless steel 80 x 40mm, 0,14 l. (5,6 OZ)	1x1
33720-19	periosteal elevator, BOIES 19cm, 9mm	1x1
91122-16	bipolar forceps pointed straight, 16,5cm total long	1x1

SET/451:	Rhinoplastiksatz / Rhinoplasty Set / Juego para rinoplastia	
07109-15	scalpel handle MINI 15,5cm	1x1
07103-00	scalpel handle no. 3 12,5cm	1x1
47380-15	nasal plastic knife, COTTLE 15cm	1x1
21272-14	cotton applicators, FARREL triangular, 14cm	2x1
09341-11	operating sciss.fine, IRIS curved, 11cm	1x1
09305-14	operating sciss.fine, JOSEPH curved, 14,5cm	1x1
09617-13	Rhinoplastic scissors, FOMON curved, 13cm	1x1
09401-18	scissors nasal, HEYMANN 18cm	1x1
47454-04	rhinoplastic osteotome, COTTLE 18cm, straight, 4mm	1x1
47454-07	rhinoplastic osteotome, COTTLE 18cm, straight, 7mm	1x1
47473-01	rhinoplastic chisel, SILVER 18cm, straight	1x1
47473-02	rhinoplastic chisel, SILVER 18cm, curved right	1x1
47473-03	rhinoplastic chisel, SILVER 18cm, curved left	1x1
47554-01	retractor, COTTLE Fig. 1 14.5cm	1x1
47556-16	FOMON Alar Hooklet 16cm	1x1
47559-20	hooklet, COTTLE-NEIVERT double, 20cm	1x1
47551-16	nasal retracator, AUFRICHT 16cm	1x1
47423-22	septum elevator, COTTLE 22cm	1x1
47426-22	septum elevator, KILLIAN 22cm	1x1
47410-04	septum elevator, McKENTY 15cm, 4mm	1x1
45206-14	ear forceps bayonet, LUCAE 14cm, without teeth	1x1
11188-12	forceps tissue, ADSON-BROWN 7x7 teeth, 12cm	1x1
47522-01	nasal rasp, FOMON 20cm, Fig. 1/2 TC	1x1
47522-04	nasal rasp, FOMON 20cm, Fig. 3/4 TC	1x1
47571-23	septum straight.fcps., ASCH 23cm	1x1
33700-05	hammer, COTTLE flat/convex D. 30mm, 240gr., 18cm	1x1
47532-19	nasal saw, JOSEPH 19cm, left	1x1
47534-19	nasal saw, JOSEPH 19cm, right	1x1
47120-75	nasal speculum, KILLIAN 75mm	1x1
47120-90	nasal speculum, KILLIAN 90mm	1x1
47223-01	WEIL-BLAKESLEY nose forceps shaft 120mm, straight, 3.0mm, Fig.1	1x1
47223-03	forceps, WEIL-BLAKESLEY shaft 120mm, straight, 4.2mm, Fig. 3	1x1
47461-00	COTTLE cartilage crusher	1x1
47255-01	nasal cut.fcps WATSON-WILLIAMS 7mm jaw straight, 120mm working lenth	1x1
25164-15	needle holder, CRILE-WOOD serrated, TC, 15cm	1x1
25164-18	needle holder, CRILE-WOOD serrated, TC, 18cm	1x1
41295-08	suction tube, FRAZIER/FERGUSSON 19cm, 30°, Charr. 8	1x1
41295-10	suction tube, FRAZIER/FERGUSSON 19cm, 30°, Charr. 10	1x1
47565-10	COTTLE columella forcep 10cm	1x1
47411-16	septum elevator, JOSEPH 16cm	1x1
47390-03	swivel knife, BALLENGER straight, 20cm, 3mm	1x1
47380-15	nasal plastic knife, COTTLE 15cm	1x1
33282-19	bone cut.fcps,COTTLE-KAZANJIAN 19cm	1x1
19216-02	hooklet sharp 2 prong, JOSEPH 2mm, 16cm	1x1
47323-19	septum fcps, MIDDLETON-JANSEN 19cm	1x1

SET/452: Endonasaler Satz / Endonasal set / Juego endonasal		
41295-08	suction tube, FRAZIER/FERGUSSON 19cm, 30°, Charr. 8	1x1
41295-10	suction tube, FRAZIER/FERGUSSON 19cm, 30°, Charr. 10	1x1
45160-15	ear knife, POLITZER 15cm	1x1
47223-01	WEIL-BLAKESLEY nose forceps shaft 120mm, straight, 3.0mm, Fig.1	1x1
47223-02	forceps, WEIL-BLAKESLEY shaft 120mm, straight, 3.6mm, Fig. 2	1x1
47223-03	forceps, WEIL-BLAKESLEY shaft 120mm, straight, 4.2mm, Fig. 3	1x1
47224-01	forceps, WEIL-BLAKESLEY shaft 120mm, 45° upcurved, size 1 3,0mm	
47224-02	forceps, WEIL-BLAKESLEY shaft 120mm, curved up, Fig.2	1x1
47120-35	nasal speculum, KILLIAN 35mm	1x1
47120-50	Nasal speculum, KILLIAN 50mm	1x1
47120-75	nasal speculum, KILLIAN 75mm	1x1
47320-00	Biopsy fcps. with cup jaws	1x1
47195-01	nasal cutting forceps, LUC 19cm Fig. 1	1x1
47240-19	nasal cutting fcps., STRUYCKEN shaft 120mm, tip width 1,0mm	1x1
47315-00	OSTROEM Antrum punch up cutting, 2mm 100mm working length	1x1
09401-18	scissors nasal, HEYMANN 18cm	1x1
47305-01	nasal scissors, str. 11cm	1x1
47332-30	EICKEN (KILLIAN) antrum cannula 3.0mm long curved, 14cm long, stainless steel	1x1
47332-25	EICKEN (KILLIAN) antrum cannula 2.5mm long curved, 14cm long, stainless steel	1x1
47423-22	septum elevator, COTTLE 22cm	1x1
47158-20	WESTMACOTT nasal dressing forceps, 20cm	1x1

**SET/453: Satz für die endoskopische Nasennebenhöhlen-Chirurgie /
Set for Endoscopic Paranasal Sinus /
Juego para cirugía endoscópica del seno paranasal**

23181-40	Sinoscopy-trocar 5mm Ø, oblique beak 8,5cm long, f. endoscope 4mm Ø w. pyramidal trocar and obturator	1x1
47103-02	nasal specula HARTMANN Fig. 2	1x1
R500-040175-000		1x1
	Sinuscope 4mm Ø, 0° angle of view autoclavable, intergrated fiber optic for illumination, 175mm work.length	
R500-040175-030		1x1
	Sinuscope 4mm Ø, 30° angle of view autoclavable, intergrated fiber optic f. illumination, 175mm work.length	
91159-19	bipolar forceps angled 2mm, 19,5cm	1x1
51293-45	tonsil injection needle 45° angled	1x1
47580-19	Sickle knife 19cm long, pointed	1x1
47415-18	FREER septum elevator, 18cm double ended, sharp/blunt	1x1
47399-01	Antrum spoon 55° 19cm	1x1
47399-02	Antrum spoon, 90°, 19cm	1x1
47388-04	Antrum curette, curved, 20cm/2,5mm, 30° oval	1x1
47423-22	septum elevator, COTTLE 22cm	1x1
41295-08	suction tube, FRAZIER/FERGUSSON 19cm, 30°, Charr. 8	1x1
41295-10	suction tube, FRAZIER/FERGUSSON 19cm, 30°, Charr. 10	1x1
47332-25	EICKEN (KILLIAN) antrum cannula 2.5mm long curved, 14cm long, stainless steel	1x1
47332-30	EICKEN (KILLIAN) antrum cannula 3.0mm long curved, 14cm long, stainless steel	1x1
47324-01	Maxillary antrum grasping forceps, straight, 90° backward opening, rigid jaw, working length 100mm	1x1
47223-30	nose forceps BLAKESLEY, straight, 3,0mm, working length 130mm	1x1
47223-35	nose forceps BLAKESLEY, straight, 3,5mm, working length 130mm	1x1
47224-30	nose forceps BLAKESLEY, 45° curved up, 3mm, working length 130mm	1x1
47305-01	nasal scissors, str. 11cm	1x1
47317-70	Sinoscopy forceps, shaft length 12cm, horizontal cutting, oval, 70°	1x1
47318-70	Sinoscopy forceps, shaft length 12cm, vertical cutting, oval, 70°	1x1
47320-00	Biopsy fcps. with cup jaws	1x1
47315-00	OSTROEM Antrum punch up cutting, 2mm 100mm working length	1x1
47316-00	OSTROEM Antrum-punch right cutting, 2mm 100mm working length	1x1
47317-00	OSTROEM Antrum-punch left cutting, 2mm 100mm working length	1x1
47240-19	nasal cutting fcps.,STRUYCKEN shaft 120mm, tip width 1,0mm	1x1
47319-35	circular fcps. straight, dia. 3,5mm cutting 360°	1x1
47320-45	circular fcps. 4,5mm Ø, 65° upcurved	1x1

**SET/460: Tonsillektomie-Adenotomie Satz /
Tonsillectomy and Adenoidectomy Set /
Juego para amigdalactomia y adenotomia**

49342-01	tongue depress.,RUSSEL-DAVIS 29 x 67mm	1x1
49342-02	tongue depress.,RUSSEL-DAVIS 33 x 75mm	1x1
49342-03	tongue depress.,RUSSEL-DAVIS 38 x 85mm	1x1
49340-00	mouth gag only, DAVIS-MEYER	1x1
49111-15	tongue depressor, HARTMANN 15cm	1x1
47235-09	nasal cutting forceps,HARTMANN 9mm	1x1
49107-19	tongue depressor, BRUENINGS 19cm	1x1
53272-14	laryngeal mirror with handle Fig. 2, D. 14mm	1x1
53272-20	laryngeal mirror with handle Fig. 5, D. 20mm	1x1
51292-00	tonsil injection needle straight	1x1
51290-05	tonsil syringe 3 ring LL 5ml	1x1
15111-09	towel forceps, BACKHAUS 9cm	6x1
89127-08	Bowl round, stainless steel 80 x 40mm, 0,14 l. (5,6 OZ)	1x1
51256-28	tonsil snare, BRUENINGS 28cm	1x1
51259-04	tonsil loops 0,4mm Ø, pack of 12 pcs.	1x1
51209-20	tonsil seizing forceps,BLOHMKE 20cm	1x1
51205-18	tonsil seizing fcps, WHITE 18cm	1x1
09435-18	tonsil scissors, BOETTCHER curved, 18cm	1x1
05150-27	aspiration tube, YANKAUER complete, 27cm	1x1
51135-01	tonsil elevator, HENKE Fig. 1, 23cm	1x1
51183-19	tonsil forceps, SCHNIDT 19cm curved	1x1
13551-20	peritoneum forceps, MIKULICZ 20cm 1x2 teeth	1x1
11102-20	forceps dressing, 20cm	1x1
11120-20	forceps tissue 1x2 teeth, 20cm	1x1
47630-00	adenoid curette, BARNHILL 21cm, Fig. 0	1x1
47630-01	adenoid curette, BARNHILL 21cm, Fig. 1	1x1
47630-02	adenoid curette, BARNHILL 21cm, Fig. 2	1x1
47630-03	adenoid curette, BARNHILL 21cm, Fig. 3	1x1
47630-04	adenoid curette, BARNHILL 21cm, Fig. 4	1x1
51131-22	tonsil dissector, HURD 22cm	1x1
25214-18	needle holder, DE-BAKEY serrated, TC, 18cm	1x1
47245-01	naso-pharyngeal fcps. JURASZ 21cm, Fig.1	1x1
91154-19	bipolar forceps, 1mm tipstraight, 19,5cm long european flat connector	1x1

**SET/470: Laryngoskopiesatz für Erwachsene /
Laryngoscopy Set for Adults /
Juego de laringoscopia para adultos**

05301-04	operation laryng.,KLEINSASSER 170x28,5x18,5x15mm	1x1
05302-02	fiberglas-light-guide for 05301-03/04/ 05 and 06	1x1
05301-03	operation laryng.,KLEINSASSER 170x26x15,5x13,5mm	1x1
05302-02	fiberglas-light-guide for 05301-03/04/05 and 06	1x1
05301-02	operation laryng.,KLEINSASSER 150x20,5x13x10,5mm	1x1
05302-01	fiberglas-light-guide	1x1
05300-01	Chest support compl.KLEINSASSER for adults	1x1
53295-23	Needle holder with ratchet, straight jaw 1,8x3,5mm, serrated, WL 23cm	1x1
53280-01	micro laryngeal grasp.forceps straight serrated 1,5x10mm	1x1
53280-02	micro laryngeal grasp.forceps curved to left,serr.1,5x8,5mm	1x1
53280-03	micro laryngeal grasp.forceps curved to right,serr.1,5x8,5mm	1x1
53280-04	micro laryngeal cup forceps straight, 2,5mm Ø, 22cm long	1x1
53280-05	micro laryngeal cup forceps angled to left, 2,5mm	1x1
53280-06	micro laryngeal cup forceps angled to right, 2,5mm	1x1
53280-07	micro laryngeal cup forceps angled up 2,5mm	1x1
53280-08	micro laryngeal scissors straight vertical cutting 22cm long	1x1
53280-09	micro laryngeal scissors curved to left	1x1
53280-10	micro laryngeal scissors curved to right	1x1
41291-25	BYRD, suction tube, self cleaning, 2.5m	1x1
41292-01	injection cannula, straight, LUER-LOCK, working length 23cm	1x1
53290-08	handle for micro-laryngeal instruments	1x1
	53290-01 - 53290-07	
53290-01	micro-laryngeal sickle knife curved	1x1
53290-02	micro-laryngeal separador, oval, horizontal	1x1
53290-05	micro-laryngeal hook, 90° angled, blunt	1x1
41312-26	Coagulation suction tube monopolar 2,5mm button 3,5mm Ø, 260mm working length, angled, HF-connector male	1x1
R060-050040-003	Monopolar HF-connecting cable, 3mtr. lg. 5mm PIN for ERBE / Storz HF-units 4mm socket instrument side	1x1

**SET/480: Tracheotomie Satz / Tracheotomy Set /
Juego para traqueotomía**

07103-00	scalpel handle no. 3 12,5cm	1x1
49107-19	tongue depressor, BRUENINGS 19cm	1x1
19220-01	retractor (trach.) pointed 1 prong, 16cm	1x1
19220-02	retractor (trach.) pointed 2 prongs, 16cm	1x1
19280-04	retractor, VOLKMANN pointed, 21,5cm, 4 teeth	2x1
55511-21	thyroid retractor, SCHOENBORN 21cm	1x1
19312-02	retractor, LANGENBECK 21cm, 30x14mm	2x1
19314-20	retractor, KOCHER-LANGENBECK 21cm, 60x20mm	2x1
21270-14	cotton applicators, FARREL threaded, 14cm	2x1
47415-18	FREER septum elevator, 18cm double ended, sharp/blunt	1x1
33718-16	periosteal elevator, JOSEPH 16cm, 4mm	1x1
09283-15	diss.scissors,METZENBAUM-FINO curved, 15cm	1x1
09110-14	operating scissors, STANDARD pointed/blunt, straight 14,5cm	1x1
47120-50	Nasal speculum, KILLIAN 50mm	1x1
47120-75	nasal speculum, KILLIAN 75mm	1x1
41295-08	suction tube, FRAZIER/FERGUSSON 19cm, 30°, Charr. 8	1x1
41295-12	suction tube, FRAZIER/FERGUSSON 19cm, 30°, Charr. 12	1x1
11102-14	forceps dressing, 14,5cm	1x1
11120-14	forceps tissue 1x2 t. 14,5 cm	2x1
11188-12	forceps tissue, ADSON-BROWN 7x7 teeth, 12cm	1x1
17110-20	dressing forceps, GROSS-MAIER straight, 20cm	1x1
51183-19	tonsil forceps, SCHNIDT 19cm curved	1x1
13310-16	hemost.fcps. ,ROCHESTER-PEAN straight,16cm	1x1
13310-14	hemost.fcps. ,ROCHESTER-PEAN straight, 14cm	1x1
13320-14	hemost.fcps.,ROCHESTER-OCHSNER 1x2 teeth, straight, 14cm	2x1
13221-12	hemost.fcps.,HALSTED-MOSQUITO curved, 12,0cm	4x1
15111-09	towel forceps, BACKHAUS 9cm	6x1
25164-15	needle holder, CRILE-WOOD serrated, TC, 15cm	1x1
19670-14	retractor, WEITLANER sharp, 14,0cm	1x1
47235-07	nasal cutting forceps,HARTMANN 7mm	1x1
55111-14	tracheal dilator, TROUSSEAU 14cm	1x1
55122-16	trachea hook, BOSE 16cm, left	1x1
55124-16	trachea hook, BOSE 16cm, right	1x1
55520-15	goitre seizing forceps, LAHEY 15cm	1x1
55501-15	goitre director, KOCHER 15cm, without hole	1x1
55240-08	trach.tube,CHEVALIER-JACKSON germ.silver,Fig.4, D. 8mm, 65m	1x1
55240-09	trach.tube,CHEVALIER-JACKSON germ.silver,Fig.5, D.9mm, 70mm	1x1
21110-14	grooved director, 14,5cm	1x1
55151-09	tube, WAGENER-MOSHER 9mm	1x1
91154-19	bipolar forceps, 1mm tip straight, 19,5cm long european flat connector	1x1

Reda Instrumente GmbH
Gänsäcker 34 - P.O. Box 131
D-78532 Tuttlingen



NUMMERNVERZEICHNIS

NUMERICAL INDEX

INDICE NUMÉRICO



www.Red-Instrumente.de

03161-0048	05217-03324	05311-03.....339	09282-15 115, 189
03161-0149	05217-04324	05311-04.....339	09282-18189
03161-0250	05230-00330	05320-01340	09283-15 115, 189
03161-03C.....51	05230-00CL.....326	05320-02340	09283-18189
03161-03T.....51	05230-01330	05320-03340	09284-12188
03165-0722	05230-01CL.....326	05320-04340	09284-15 115, 188
03167-0322	05230-02330	05321-01340	09284-18188
03171-0052	05230-02CL.....326	05321-02340	09285-12 188, 297
03171-0152	05230-03330	05321-03340	09285-15 115, 188,
03171-0252	05230-03CL.....326	05321-04340 297
03180-9023	05230-04330	05322-01341	09285-18 188, 297
03180-9223	05230-04CL.....326	05322-02341	09285-20297
03180-9323	05233-18333	05322-03341	09285-23297
03192-0024	05234-28333	05322-04341	09285-25297
03192-0124	05238-02332	05322-05341	09285-28297
03193-0025	05238-03332	05322-06341	09285-30297
03193-0125	05238-12332	05322-07341	09286-15 115, 189
03193-2024, 25	05238-13332	07296-00221	09286-18189
03194-0027	05239-01333	07490-00220	09287-15 115, 189
03194-0127	05239-02333	07490-01220	09287-18189
03195-0026	05239-03332	07490-02220	09302-14190
03195-0126	05300-01335	07495-31221	09303-14190
03195-0626	05300-02335	07496-31221	09304-14 116, 190
03195-0726	05300-03335	07498-00221	09305-14 116, 190
03195-0826	05300-04335	07499-00221	09310-12191
03196-0027	05300-05335	07499-01221	09310-15191
05150-21284	05300-06335	09110-11117	09314-12191
05150-27284	05301-01334	09110-13.....117	09321-15191
05151-01284	05301-02334	09110-14.....117	09321-18191
05151-02284	05301-03334	09111-11117	09340-09192
05203-00327	05301-04334	09111-13.....117	09340-10192
05204-00327	05301-05334	09111-14117	09340-11 117, 192
05210-00328	05301-06334	09270-15189	09341-09192
05210-01328	05301-07334	09270-18189	09341-10192
05210-02328	05302-01334, 337,	09271-15189	09341-11..... 117, 192
05210-03328341	09271-18189	09342-08192
05210-04328	05302-02334, 337,	09274-15189	09343-08192
05211-00323341	09274-18189	09344-11..... 117, 192
05211-01323	05302-03334, 337,	09275-15189	09345-11..... 117, 192
05211-02323341	09275-18189	09346-11.....192
05211-03323	05303-01337	09280-12188	09348-01193
05211-04323	05303-10338, 341	09280-15 115, 188	09348-02193
05212-03322	05304-01338	09280-18188	09348-03193
05212-04322	05304-02338	09281-12 188, 297	09348-04193
05213-03329	05305-01336	09281-15 115, 188,	09348-05193
05213-03CL.....325	05305-02336297	09348-06193
05213-04329	05310-01339	09281-18 188, 297	09349-12194
05213-04CL.....325	05310-02339	09281-20297	09350-09195
05215-02331	05310-03339	09281-23297	09350-10194
05215-03331	05310-04339	09281-25297	09351-09195
05215-04331	05311-01339	09281-28297	09352-09195
05217-02324	05311-02339	09281-30297	09352-10194

09353-09.....	195	09981-11.....	192	10206-11.....	202	11260-15.....	95
09354-10.....	195	09982-12.....	197	10206-11SC.....	202	11270-12.....	95
09355-10.....	195	09983-12.....	197	10207-11.....	202	11270-15.....	95
09356-10.....	195	09984-11.....	196	10207-11SC.....	202	11272-15.....	151
09357-10.....	195	09985-11.....	196	10220-00.....	204	11273-15.....	151
09358-11.....	194	09993-15.....	191	10220-00T.....	204	11401-01.....	96
09360-11.....	196	09995-12.....	191	10220-25.....	204	11403-03.....	96
09361-11.....	196	10010-19.....	200	10220-25T.....	204	11403-04.....	96
09362-11.....	196	10011-19.....	200	10220-45.....	204	11404-04.....	96
09363-11.....	196	10012-19.....	200	10220-45T.....	204	11405-05.....	96
09364-10.....	298	10013-19.....	200	10220-60.....	204	11407-07.....	96
09370-11.....	116, 196	10014-19.....	200	10220-60T.....	204	13551-18.....	283
09371-11.....	116, 196	10015-19.....	200	10220-90.....	204	17131-21.....	295
09374-11.....	116, 196	10028-14.....	201	10220-90T.....	204	17133-17.....	295
09375-11.....	116, 196	10029-14.....	201	10226-11.....	205	17210-13.....	155
09401-18.....	198	10030-18.....	201	10226-14.....	205	17210-16.....	155
09403-15.....	198	10031-18.....	201	10226-18.....	205	17210-18.....	155
09405-16.....	198	10032-23.....	201	10226-18T.....	205	19122-13.....	263
09405-16TC.....	198	10033-23.....	201	10227-11.....	205	19210-12.....	246
09406-10.....	198	10034-14.....	201	10227-14.....	205	19211-12.....	246
09407-10.....	198	10035-14.....	201	10227-18.....	205	19212-01.....	246
09425-17.....	296	10036-18.....	201	10227-18T.....	205	19212-02.....	246
09427-17.....	296	10037-18.....	201	10228-11.....	205	19213-12.....	246
09435-18.....	296	10038-23.....	201	10228-14.....	205	19214-13.....	246
09437-19.....	296	10039-23.....	201	10228-18.....	205	19214-18.....	246
09439-17.....	296	10044-14.....	201	10228-18T.....	205	19215-01.....	246
09540-16.....	191	10045-14.....	201	10229-11.....	205	19215-02.....	246
09541-16.....	191	10048-14.....	201	10229-14.....	205	19215-03.....	246
09542-16.....	191	10049-14.....	201	10229-18.....	205	19215-13.....	246
09543-16.....	191	10050-12.....	116	10229-18T.....	205	19215-18.....	246
09544-16.....	191	10050-14.....	201	10230-11.....	205	19216-01.....	247
09545-16.....	191	10050-18.....	201	10230-14.....	205	19216-02.....	247
09617-13.....	198	10051-14.....	201	10230-18.....	205	19216-05.....	247
09802-09.....	199	10051-18.....	201	10230-18T.....	205	19216-07.....	247
09802-11.....	199	10061-19.....	200	11112-18.....	294	19216-10.....	247
09804-14.....	199	10061-19SC.....	200	11112-21.....	294	19217-03.....	247
09805-09.....	199	10061-19TC.....	200	11112-25.....	294	19217-05.....	247
09823-12.....	197	10061-23.....	200	11116-18.....	294	19217-07.....	247
09824-12.....	197	10061-23SC.....	200	11116-21.....	294	19218-01.....	248
09825-12.....	197	10061-23TC.....	200	11116-25.....	294	19218-02.....	248
09826-12.....	197	10201-11.....	202	11120-11.....	95	19218-11.....	248
09828-12.....	197	10201-11SC.....	202	11126-18.....	294	19220-01.....	249
09829-12.....	197	10202-11.....	203	11126-21.....	294	19220-02.....	249
09831-12.....	118, 299	10202-14.....	119, 203	11126-25.....	294	19220-03.....	249
09835-12.....	118, 299	10202-14T.....	203	11170-12.....	97	19220-04.....	249
09966-11.....	188	10202-18.....	203	11170-15.....	97	19221-01.....	249
09967-11.....	188	10202-18T.....	203	11180-12.....	97	19221-02.....	249
09970-14.....	188	10203-11.....	203	11180-15.....	97	19221-03.....	249
09970-18.....	188	10203-14.....	119, 203	11190-10.....	95, 151	19221-04.....	249
09971-14.....	188	10203-14T.....	203	11258-15.....	151	19226-02.....	249
09971-18.....	188	10203-18.....	203	11259-15.....	151	19226-03.....	249
09980-11.....	192	10203-18T.....	203	11260-12.....	95	19226-04.....	249

19227-02249	21290-1264	25673-18T124	33470-06104
19227-03249	21290-1464	25674-14124	33474-96103
19227-04249	21290-1664	25674-18124	33474-97103
19283-01114	21292-1264	25675-14124	33474-98103
19283-02114	21292-1464	25675-18124	33475-00103
19283-03114	21292-1664	25676-14124	33475-01103
19314-07263	21310-1564	25677-14124	33475-02103
19314-14263	21320-1264	25691-18124	33475-03103
19314-20263	21320-1864	25700-18123	33475-04103
19344-14263	21350-25347	25701-18123	33475-05103
19344-20263	21360-26347	25720-12123	33475-06103
19344-26263	21370-25347	25720-12D123	33476-01104, 258
19499-00263	23128-19215	25720-13123	33476-02104, 258
19610-07110	23140-02215	25720-13D123	33476-03104, 258
19611-07110	23181-40215	25720-14123	33485-99105
19620-07110	25110-12209	25720-14D123	33486-00105
19620-10110	25114-12209	25730-18123	33486-01105
19621-07110	25128-13209	25730-18D123	33486-02105
19621-10110	25129-13209	25731-12123	33486-99105
19630-10110	25130-13209	25731-13123	33487-00105
19631-10110	25134-13209	25731-14123	33487-01105
19634-10110	25136-11209	25731-18123	33487-02105
19635-10110	25137-11209	25731-18D123	33487-99258
19650-10111	25140-13209	33115-15106	33488-00258
19651-10111	25144-13209	33117-15106	33488-01258
19654-13111	25160-15209	33119-15106	33488-02258
19655-13111	25164-15209	33131-15106	33490-10103
19670-14111	25660-12123	33133-15106	33490-20103
19670-16111	25660-13123	33148-18106	33490-30103
19671-14111	25660-14123	33150-16107	33490-40103
19671-16111	25661-12123	33151-16107	33490-50103
19672-11113, 264	25661-13123	33156-18107	33495-16103
19673-11113, 264	25661-14123	33157-02107	33496-00105
19674-15112	25668-18124	33157-03107	33496-01105
19675-13113	25670-14124	33201-18107	33496-12105
19677-10113, 264	25670-18124	33205-18107	33498-00105
19677-13113, 264	25671-12D123	33211-15107	33498-01105
19683-17112	25671-13D123	33213-15107	33498-12105
19684-14112	25671-14124	33280-15108	33600-0298
19685-14112	25671-14D123	33281-15108	33600-0398
19690-17265	25671-18124	33282-19108, 208	33600-0498
19691-17265	25672-14124	33283-17108, 208	33600-0598
21115-1063	25672-14D124	33393-18104	33602-0498
21270-1263	25672-14T124	33469-96104	33602-0698
21270-1463	25672-18124	33469-97104	33602-0898
21270-1663	25672-18D124	33469-98104	33602-1098
21272-1263	25672-18T124	33470-00104	33602-1298
21272-1463	25673-14124	33470-01104	33602-1498
21272-1663	25673-14D124	33470-02104	33602-1698
21277-1263	25673-14T124	33470-03104	33604-0498
21277-1463	25673-18124	33470-04104	33604-0698
21277-1663	25673-18D124	33470-05104	33604-0898

33604-1098	33665-12 100	41295-15 125, 213	41511-01.....181
33604-1298	33686-25259	41297-06213	41511-02.....181
33604-1498	33693-32 102, 259	41297-07213	41511-03.....181
33604-1698	33694-01 102, 259	41297-08213	41511-04.....181
33605-0498	33694-02259	41297-09213	41511-05.....181
33605-0698	33694-03 102, 259	41297-10213	41512-01181
33605-0898	33695-40260	41297-11.....213	41512-02181
33605-1098	33696-75260	41297-12213	41512-03181
33605-1298	33698-98 102, 260	41299-03128	41512-04181
33605-1498	33700-05 102, 260	41299-05128	41512-05181
33605-1698	33700-08102	41299-07128	41803-0157
33620-0299	33701-1691	41300-00129	41807-0057
33620-0399	33702-1590	41300-02126	41810-1057
33620-0499	33703-1590	41300-03126	41821-2157, 148
33620-0599	33707-1786	41300-04126	41842-44148
33620-0699	33708-1986	41300-05126	41843-50148
33623-0299	33710-1986	41302-02125	41850-41148
33623-0399	33711-16.....87	41303-09 126, 214	43376-13250
33623-0499	33712-1687	41303-12 126, 214	43377-13250
33623-0599	33713-1687	41303-15 126, 214	43602-01261
33623-0699	33713-1787	41303-18 126, 214	43602-02261
33626-2598, 235	33714-1586	41303-25 126, 214	43602-03261
33626-3598, 235	33716-1892	41303-30 126, 214	43613-00262, 293
33628-0398	33718-1688	41303-45 126, 214	43614-00262, 293
33628-0598	33720-19226	41304-06126	43614-01262, 293
33652-0299, 229	33720-20226	41304-08126	43614-12262, 293
33652-0399, 229	33722-0690, 227	41304-10126	43614-23262, 293
33652-0499, 229	33722-0890, 227	41305-05129	43614-34262, 293
33652-0699, 229	33724-0292	41305-06129	43614-45262, 293
33652-0899, 229	33724-0392	41305-07129	43614-56262, 293
33652-1099, 229	33724-0492	41305-08129	43614-67262, 293
33652-1299, 229	33740-1989	41305-09129	43614-78262, 293
33652-1599, 229	33741-1889	41305-10129	44650-01131
33654-0299, 229	33742-1889	41305-12129	44650-02131
33654-0399, 229	33743-1889	41305-15129	44651-01131
33654-0499, 229	33761-21290	41305-18129	44651-02131
33654-0699, 229	34520-02302	41305-20129	44652-01131
33654-0899, 229	34520-03302	41305-25129	44652-02131
33654-1099, 229	34520-04302	41305-30129	45009-0253
33654-1299, 229	41291-20348	41306-00127	45009-0353
33654-1599, 229	41291-25348	41306-05 125, 127	45009-0453
33660-15228	41291-30348	41306-07 125, 127	45010-0053
33660-20228	41292-01349	41306-09 125, 127	45010-2053
33664-04100	41292-02349	41307-00129	45010-3053
33664-06100	41294-40213	41308-00127	45010-4553
33664-08100	41295-06 125, 213	41312-10 211, 348	45010-5553
33664-10100	41295-07 125, 213	41312-26 211, 348	45010-6553
33664-12100	41295-08 125, 213	41510-01181	45010-7553
33665-04100	41295-09 125, 213	41510-02181	45011-00.....53
33665-06100	41295-10 125, 213	41510-03181	45011-03.....53
33665-08100	41295-11..... 125, 213	41510-04181	45011-04.....53
33665-10100	41295-12 125, 213	41510-05181	45011-05.....53

45011-07.....53	45060-0358	45111-00.....68	45193-0366, 250
45011-08.....53	45060-0458	45112-00.....68	45194-0167
45012-0053	45060-0558	45112-01.....68	45194-0267
45012-4053	45061-0058	45112-02.....68	45194-0367
45012-5553	45070-0158	45112-03.....69	45194-0467
45012-6553	45070-0258	45112-04.....69	45195-0067
45012-7553	45070-0358	45112-05.....69	45195-0167
45014-0053	45070-0458	45114-00.....68	45195-0267
45014-4553	45070-0558	45115-00.....68	45195-1566
45014-5553	45070-0658	45115-01.....68	45201-11.....94, 152
45014-6553	45071-0058	45115-02.....68	45201-1394, 152
45014-7553	45072-0159	45115-03.....69	45203-11.....94, 152
45015-0053	45073-0159	45115-04.....69	45206-1494, 152
45015-4553	45073-0259	45115-05.....69	45206-1694, 152
45015-5553	45073-0359	45116-00.....68	45207-1694, 152
45015-6553	45073-0459	45117-00.....68	45208-1494, 152
45018-0053	45073-0559	45117-01.....68	45209-1297
45018-5053	45073-0659	45117-02.....68	45220-1672
45018-6053	45074-0159	45117-03.....69	45222-1772
45018-7053	45075-0059	45117-04.....69	45225-0272
45018-8053	45076-0159	45117-05.....69	45243-1474, 155
45019-3054	45080-0060	45133-0170	45245-1274
45019-4054	45090-0060	45133-0270	45246-1274
45019-4554	45090-0260	45133-0370	45246-1474
45019-5054	45090-0360	45133-0470	45251-1073
45019-5554	45090-0460	45133-0570	45253-1173
45019-6054	45090-0560	45150-1870	45255-0875
45019-6554	45090-0660	45151-1670	45257-0875, 175
45019-7054	45090-0860	45152-0170	45261-0875
45019-7554	45091-0061	45152-0270	45261-1475
45020-3054	45091-0161	45153-1671	45261-1675
45020-4054	45091-0261	45160-1571	45263-0875
45020-4554	45091-0361	45162-1871	45263-1475
45020-5054	45091-0461	45164-1771	45265-0875
45020-5554	45091-1561	45165-1771	45267-2075, 175
45020-6054	45091-1761	45171-1265	45267-2575, 175
45020-6554	45091-2261	45173-1265	45267-3075
45020-7054	45096-0062	45180-0165	45269-3075
45020-7554	45096-5061	45180-0265	45271-0875
45030-0455	45096-7561	45180-0365	45273-0875
45030-0655	45097-0161	45181-1365	45274-0875
45030-0755	45097-0261	45184-1665	45275-0875, 175
45030-0855	45097-0361	45185-1565	45276-0875
45030-1055	45097-1061	45190-0166	45300-3080
45036-0356	45097-1561	45190-0266	45310-4080
45036-0656	45109-0068	45192-0166	45312-5580
45036-0756	45110-0068	45192-0266	45313-5580
45036-0856	45110-0168	45192-0366	45315-5580
45036-0955	45110-0268	45192-0466	45317-5580
45036-1055	45110-0369	45192-0566	45320-7080
45060-0158	45110-0469	45193-0166, 250	45321-7080
45060-0258	45110-0569	45193-0266, 250	45322-7080

45324-03 82	45704-15 122	45737-15 136	47050-07 140
45325-03 82	45705-15 122	45741-03 136	47060-01 140
45350-40 76	45706-35 122	45741-06 136	47060-02 140
45350-70 76	45708-16 121	45741-10 136	47060-03 140
45352-40 76	45709-10 120	45743-03 136	47102-01 141
45353-60 76	45709-14 120	45743-06 136	47102-02 141
45355-60 76	45709-16 120	45743-10 136	47102-03 141
45357-40 76	45709-20 120	45745-03 136	47103-01 142
45359-40 76	45709-26 120	45745-06 136	47103-02 142
45360-35 76	45709-28 120	45745-10 136	47103-03 142
45361-01 77	45709-30 120	45746-20 137	47112-01 143
45361-02 77	45710-14 120	45747-03 136	47112-02 143
45361-03 77	45710-15 135	45747-06 136	47112-03 143
45361-04 77	45710-20 120	45747-10 136	47113-03 143
45361-05 77	45710-25 120	45748-16 137	47116-13 144
45362-45 77	45711-15 135	45749-16 137	47116-14 144
45363-45 77	45713-15 135	45750-16 137	47118-13 144
45365-45 77	45715-17 135	45751-16 93	47120-35 144
45367-50 77	45720-03 135	45753-16 93	47120-35S 145
45369-50 77	45720-06 135	45755-16 93	47120-50 144
45370-50 81	45720-10 135	45756-10 138	47120-50S 145
45371-40 81	45722-03 135	45756-20 138	47120-75 144
45372-60 81	45722-04 135	45756-30 138	47120-75S 145
45385-01 84	45722-06 135	45756-40 138	47120-90 144
45385-02 84	45722-08 135	45756-50 138	47120-90S 145
45387-01 84	45722-10 135	45757-16 93	47124-35 146
45387-02 84	45722-12 135	45758-01 93	47124-35S 147
45390-35 78	45722-15 135	45758-02 93	47124-50 146
45390-50 78	45722-20 135	45758-03 93	47124-50S 147
45391-35 78	45722-25 135	45760-01 133	47124-75 146
45392-35 78	45724-03 135	45760-02 133	47124-75S 147
45393-50 78	45724-04 135	45762-01 133	47124-90 146
45394-50 78	45724-06 135	45762-02 133	47124-90S 147
45400-01 79	45724-08 135	45766-35 132	47139-12 345
45400-02 79	45724-10 135	45766-40 132	47139-14 345
45400-03 79	45724-12 135	45766-45 132	47139-16 345
45401-25 79	45724-15 135	45766-50 132	47139-18 345
45402-10 79	45724-20 135	45770-01 134	47151-15 149
45403-13 79	45724-25 135	45770-16 137	47151-18 149
45404-13 79	45725-05 135	45771-16 137	47154-20 150
45410-01 83	45725-10 135	45802-16 88	47155-20 150
45411-01 83	45730-03 136	45803-16 88	47158-20 154
45412-01 83	45730-06 136	45805-16 88	47159-20 154
45413-01 83	45730-10 136	45806-16 88	47161-16 154
45414-01 83	45732-03 136	45806-17 92	47161-20 154
45430-00 85	45732-06 136	45807-20 91	47167-18 156
45440-19 85	45732-10 136	47050-01 140	47169-18 156
45701-01 122	45733-05 136	47050-02 140	47171-14 155
45701-02 122	45733-10 136	47050-03 140	47173-14 155
45702-01 121	45735-05 136	47050-04 140	47181-18 157
45702-02 121	45735-10 136	47050-05 140	47185-18 157
45703-15 122	45736-15 136	47050-06 140	47191-01 158

47191-02 158	47231-01 171	47317-00 184	47332-30 212
47191-03 158	47231-02 171	47317-11 178	47332-40 212
47191-04 158	47232-00 172	47317-70 178	47342-25 261
47192-18 158	47233-00 173	47317-90 178	47342-30 261
47193-01 158	47233-01 173	47318-00 184	47342-40 261
47193-02 158	47233-02 174	47318-11 178	47345-15 212
47195-01 157	47233-03 174	47318-70 178	47347-20 227
47195-02 157	47235-05 169	47318-90 178	47350-26 162
47197-01 157	47235-07 169	47319-00 15	47351-26 162
47197-02 157	47235-09 169	47319-35 186	47352-24 163
47223-00 164	47235-11 169	47319-45 186	47355-03 163
47223-01 164	47235-13 307	47320-00 167	47370-16 216
47223-02 164	47235-15 307	47320-11 178	47371-16 216
47223-03 164	47239-01 169	47320-35 186	47372-16 216
47223-04 164	47239-02 169	47320-45 186	47372-17 219
47223-05 164	47241-00 165	47320-70 178	47373-16 216
47223-30 180	47242-00 165	47320-90 178	47374-16 216
47223-35 180	47242-01 165	47321-00 185	47375-16 216
47223-40 180	47243-00 310	47321-11 176	47375-19 216
47224-00 164	47244-00 311	47321-70 178	47376-16 217
47224-01 164	47245-01 311	47321-90 178	47377-13 219
47224-02 164	47245-02 311	47322-00 185	47379-16 217
47224-03 164	47246-18 310	47322-11 178	47380-15 217
47224-04 164	47251-21 161	47322-70 178	47382-15 217
47224-05 164	47255-01 166	47322-90 178	47384-15 217
47224-30 180	47255-02 166	47323-00 185	47385-15 217
47224-35 180	47256-20 206	47323-10 178	47386-01 217
47224-40 180	47303-03 109, 182	47323-19 159	47386-02 217
47225-01 164	47303-04 109, 182	47323-80 178	47387-01 256
47225-02 164	47303-05 109, 182	47324-00 185	47387-02 256
47225-03 164	47303-06 109, 182	47324-01 176	47388-01 257
47225-04 164	47304-01 182	47324-02 176	47388-02 257
47226-01 168	47304-02 182	47324-03 177	47388-03 257
47226-02 168	47304-03 182	47324-04 177	47388-04 257
47226-03 168	47304-04 182	47324-05 177	47388-05 257
47226-30 180	47305-01 187	47325-00 185	47390-03 218
47226-35 180	47305-02 187	47325-01 179	47390-04 218
47226-40 180	47305-03 187	47325-02 179	47390-05 218
47227-01 168	47310-00 184	47325-03 179	47392-03 218
47227-02 168	47311-00 184	47325-19 159	47392-04 218
47227-03 168	47311-10 109	47326-01 179	47392-05 218
47227-30 180	47311-25 109	47326-02 179	47399-01 257
47227-35 180	47311-30 109	47326-03 179	47399-02 257
47227-40 180	47312-00 184	47327-01 179	47410-04 92, 222
47230-00 170	47313-00 184	47327-02 179	47410-05 92, 222
47230-01 170	47314-00 184	47327-03 179	47410-16 222
47230-02 170	47315-00 184	47331-20 212	47411-16 222
47230-03 170	47316-00 184	47331-25 212	47412-20 226
47230-04 170	47316-11 178	47331-30 212	47413-19 222
47230-05 170	47316-16 183	47331-40 212	47414-21 222
47230-06 170	47316-70 178	47332-20 212	47415-18 91, 223
47231-00 171	47316-90 178	47332-25 212	47417-19 223

47419-19223	47472-16232	47541-14251	47642-01309
47420-01223	47473-01233	47542-12251	47642-02309
47420-02223	47473-02233	47551-16251	47642-03309
47420-03223, 261	47473-03233	47551-16CL251	49102-16268
47420-04224	47474-01233	47552-16251	49104-15268
47420-20224	47474-02233	47553-15252	49105-16268
47421-21224	47474-03233	47554-01253	49106-01268
47421-23224	47475-04234	47554-02253	49107-19268
47422-22224	47475-06234	47554-03253	49108-15268
47423-22224	47475-08234	47555-08253	49109-19268
47424-16225	47482-05236	47556-16253	49110-19269
47425-19225	47484-04236	47557-17253	49111-15269
47426-22225	47484-06236	47558-15254	49115-01269
47427-21261	47484-08236	47559-20252	49115-02269
47428-21225	47486-16236	47560-18254	49117-11269
47430-22225	47487-16236	47562-18254	49119-14270
47450-04100, 230	47489-16236	47563-22255	49230-11270
47451-04100, 230	47502-16238	47564-16254	49231-12270
47454-04100, 231	47504-18238	47565-10153	49231-14270
47454-07100, 231	47507-17238	47566-12252	49231-16270
47454-09100, 231	47507-18238	47568-08255	49235-19270
47454-12100, 231	47511-21239	47569-14250	49250-16270
47455-06231	47513-21239	47571-23160	49250-18270
47457-03235	47514-16239	47572-23160	49255-16270
47457-05235	47516-16239	47573-23160	49265-12271
47458-04231	47518-21239	47575-23160	49265-14271
47458-07231	47520-21240	47601-21256	49267-12271
47458-09231	47522-01241	47607-01256	49270-16271
47458-12231	47522-04241	47607-02256	49270-19271
47460-04231	47522-05241	47607-03256	49272-13271
47460-07231	47522-07241	47607-04256	49274-09271
47460-12231	47522-09241	47607-05256	49274-11271
47461-00237	47523-01238	47607-06256	49274-13271
47463-10234	47523-02238	47620-00308	49274-15271
47463-12234	47524-01238	47620-01308	49287-02272
47463-14234	47525-20238	47620-02308	49287-03272
47470-04232	47526-16243	47620-03308	49287-04272
47470-05232	47526-20238	47620-04308	49287-05272
47470-06232	47527-16243	47620-05308	49288-02272
47470-07232	47528-01242	47620-06308	49288-03272
47471-02101, 232	47528-02242	47630-00308	49288-04272
47471-03101, 232	47529-16243	47630-01308	49288-05272
47471-04101, 232	47530-00130, 244	47630-02308	49310-00273
47471-05101, 232	47530-01130, 244	47630-03308	49310-01273
47471-06101, 232	47530-02130, 244	47630-04308	49310-02273
47471-07101, 232	47532-19244	47636-01309	49310-03273
47471-08101, 232	47533-19244	47636-02309	49310-04273
47471-10101, 232	47534-19244	47636-03309	49310-05273
47471-12101, 232	47535-01245	47636-04309	49310-09274
47472-10232	47535-02245	47641-01309	49310-10274
47472-12232	47535-20245	47641-02309	49310-11274
47472-14232	47540-16251	47641-03309	49310-12274

49315-00275	50237-3531	51185-19.....281	53131-20354
49315-01275	50237-4031	51187-19.....281	53132-20354
49315-02275	50237-4531	51191-19.....281	53132-30354
49315-03275	50237-5031	51193-19.....281	53132-40354
49315-10275	50237-6031	51202-19281	53132-50354
49317-00276	50237-7031	51203-19281	53132-60354
49317-01276	50238-3531	51205-18281	53150-00354
49317-02276	50238-4031	51205-23281	53152-00354
49317-03276	50238-4531	51207-21281	53154-00354
49317-10276	50238-5031	51209-20281	53155-00354
49320-00277	50242-0730	51210-20282	53157-00354
49320-01277	50242-0830	51211-21282	53158-02354
49320-02277	50242-1030	51213-21282	53158-03354
49320-03277	50242-1530	51214-20283	53160-02354
49320-10277	50242-1830	51215-20283	53160-03354
49320-20277	50242-2030	51219-22282	53162-00354
49340-00277	50242-2330	51250-28301	53164-01354
49341-00277	50242-2530	51252-28301	53164-02354
49342-01278	50242-2730	51256-28301	53166-00354
49342-02278	50242-3030	51257-40302	53170-00354
49342-03278	50242-3530	51257-50302	53175-00354
49342-04278	50242-4030	51259-03302	53177-01354
49342-05278	50242-4530	51259-04302, 319	53177-02354
49345-01279	50242-5030	51259-05302	53230-01356
49345-02279	50242-6030	51260-00300	53230-02356
49345-03279	50242-7030	51265-00303	53230-03356
49345-04279	51103-18.....288	51270-00305	53230-04356
49345-05279	51103-20.....288	51290-02210, 306	53230-05356
49360-10280	51103-22.....288	51290-05210, 306	53230-06356
49400-01280	51104-18.....288	51290-10210, 306	53230-07356
50236-0630	51109-24.....289	51290-20210, 306	53230-08356
50236-0830	51111-23289	51291-00210, 306,	53240-01356
50236-1030	51131-22.....290344	53240-02356
50236-1430	51133-23.....290	51292-00210, 306,	53240-03356
50236-1830	51134-21.....290344	53240-04356
50236-2330	51135-01.....290	51293-00210, 306,	53240-05356
50236-3130	51135-02.....290344	53240-06356
50236-3530	51139-25.....291	51293-45210, 306,	53240-07356
50236-4030	51143-24.....291344	53240-08356
50236-4530	51151-19.....292	51293-90210, 306,	53250-01356
50236-5030	51165-22.....285344	53250-02356
50236-6030	51167-22.....285	53101-22343	53250-03356
50236-7030	51168-23.....285	53102-20343	53250-04356
50237-0631	51170-24.....286	53103-22343	53250-05356
50237-0831	51171-22.....286	53111-18.....342	53250-06356
50237-1031	51172-19.....287	53115-01.....342	53250-07356
50237-1431	51173-21.....287	53115-02.....342	53250-08356
50237-1831	51174-21.....287	53115-03.....342	53260-01356
50237-2331	51176-20.....304	53115-04.....342	53260-02356
50237-2531	51177-23.....287	53121-24343	53260-03356
50237-2731	51181-19.....281	53122-00319	53260-04356
50237-3031	51183-19.....281	53130-00354	53260-05356

53260-06	356	53290-05	352	91010-02	34	91127-16.....	36
53260-07	356	53290-06	352	91010-03	34	91142-16.....	37
53260-08	356	53290-07	352	91010-11.....	34	91144-16.....	37
53270-08	346	53290-08	353	91010-12	34	91146-16.....	37
53270-10	346	53290-11.....	353	91010-13	34	91152-19.....	37
53270-12	346	53290-12	353	91010-14	34	91154-19.....	37
53270-14	346	53290-13	353	91010-15	34	91157-19.....	37
53270-16	346	53290-14	353	91010-16	34	91159-19.....	37
53270-18	346	53290-15	353	91010-17	34	91160-03N.....	40
53270-20	346	53290-16	353	91010-18	34	91160-05N.....	40
53270-22	346	53295-23	349	91010-21	34	91160-10N.....	40
53270-24	346	55111-13.....	314	91010-31	34	91160-20N.....	40
53270-26	346	55111-14.....	314	91010-33	34	91162-05N.....	40
53270-28	346	55113-14.....	314	91010-34	34	91162-10N.....	40
53270-30	346	55115-07.....	314	91010-35	34	91162-19.....	38
53272-08	346	55116-15.....	314	91010-36	34	91164-19.....	38
53272-10	346	55117-17.....	314	91011-51.....	35	91166-03N.....	41
53272-12	346	55118-16.....	315	91011-52.....	35	91166-05N.....	41
53272-14	346	55119-16.....	315	91011-53.....	35	91166-10N.....	41
53272-16	346	55120-15	315	91011-54.....	35	91166-19.....	38
53272-18	346	55122-16	315	91011-55.....	35	91166-20N.....	41
53272-20	346	55124-16	315	91011-56.....	35	91167-19.....	38
53272-22	346	55151-05	315	91011-61.....	35	91168-05N.....	41
53272-24	346	55151-07	315	91011-62.....	35	91168-10N.....	41
53272-26	346	55151-09	315	91020-01	35	91169-19.....	38
53272-28	346	55220-04	316	91020-02	35	91172-03.....	38
53272-30	346	55220-05	316	91020-03	35	91172-07.....	38
53274-12	346	55220-06	316	91020-04	35	91172-12.....	38
53276-10	346	55220-07	316	91022-05	35	91176-19.....	44
53280-01	350	55220-08	316	91022-10	35	91177-20.....	44
53280-02	350	55220-09	316	91022-20	35	91178-14.....	45
53280-03	350	55220-10	316	91024-10	35	91179-18N.....	43
53280-04	351	55220-11.....	316	91024-15	35	91180-05N.....	40
53280-05	351	55220-12	316	91024-20	35	91180-10N.....	40
53280-06	351	55220-13	316	91030-02	35	91180-20N.....	40
53280-07	351	55240-04	316	91030-04	35	91182-10N.....	40
53280-08	351	55240-05	316	91030-06	35	91182-20N.....	40
53280-09	351	55240-06	316	91102-11	36	91200-05N.....	40
53280-10	351	55240-07	316	91104-11	36	91200-10N.....	40
53280-11.....	351	55240-08	316	91109-11	36	91200-20N.....	40
53280-12	351	55240-09	316	91110-03N	40	91201-20S.....	42
53280-16	350	55240-10	316	91110-05N	40	91202-05N.....	40
53280-17	350	55240-11.....	316	91110-10N	40	91202-10N.....	40
53280-18	350	55240-12	316	91112-03N	40	91202-20N.....	40
53280-19	351	55240-13	316	91112-05N	40	91206-05N.....	41
53280-20	351	55501-15	317	91112-10N	40	91206-10N.....	41
53280-21	351	55503-15	317	91113-11	36	91206-20N.....	41
53280-22	351	55511-21.....	317	91115-11	36	91207-10N.....	41
53290-01	352	55520-15	318	91122-16.....	36	91208-10N.....	41
53290-02	352	55520-20	318	91123-16.....	36	91220-10N.....	40
53290-03	352	55523-17	318	91124-16.....	36	91220-20N.....	40
53290-04	352	91010-01	34	91125-16.....	36	91222-10N.....	40

91222-20N.....40	R400-027175-070...15
91226-05N.....41	R400-040175-000...15
91226-10N.....41	R400-040175-030...15
91226-20N.....41	R400-040175-045...15
91227-10N.....41	R400-040175-070...15
91228-10N.....41	R501-027041-000...17
91240-10N.....40	R501-027041-030...17
91242-10N.....40	R501-040050-000...17
91246-05N.....41	R501-040050-030...17
91246-10N.....41	R503-100148-070...17
91246-20N.....41	R503-100173-070...17
91300-10N.....40	R503-110145-090...17
91300-20N.....40	R503-110173-090...17
93250-15T123	R805-130402-034...14
93250-18T123	R900-000000-01.....20
93251-15T123	R900-000000-02.....20
93251-18T123	R900-000000-03.....20
93260-15T123	R900-000000-04.....20
93260-18T123	R900-000000-05.....20
93261-15T123	R900-000000-06.....20
93261-18T123	R900-000000-07.....20
93755-14207	R900-000000-09.....20
93756-14207	R900-000000-11.....20
93757-14207	R900-000000-13.....20
R010-030302-000...18	R900-000000-15.....20
R010-030302-030...18	R900-000000-21.....20
R010-050240-000...18	R900-000000-31.....20
R010-050240-030...18	R900-035180-00.....19
R010-050240-070...18	R900-035230-00.....19
R010-055490-000...18	R900-035300-00.....19
R010-055490-030...18	R900-035350-00.....19
R065-020080-003...39	R900-048180-00.....19
R065-020080-005...39	R900-048230-00.....19
R065-020080-103...39	R900-048250-00.....19
R065-020080-105...39	R900-048300-00.....19
R065-040000-003...39	R900-048350-00.....19
R065-040000-005...39	R901-035180-00.....19
R065-040000-103...39	R901-035230-00.....19
R065-040000-105...39	R901-035300-00.....19
R065-040125-003...39	R901-035350-00.....19
R065-040125-005...39	R901-048180-00.....19
R065-040125-103...39	R901-048230-00.....19
R065-040125-105...39	R901-048250-00.....19
R065-040285-003...39	R901-048300-00.....19
R065-040285-005...39	R901-048350-00.....19
R065-040285-103...39	
R065-040285-105...39	
R300-040302-000...16	
R300-040302-030...16	
R300-040302-070...16	
R400-027175-000...15	
R400-027175-030...15	

Reda Instrumente GmbH
Gänsäcker 34 - P.O. Box 131
D-78532 Tuttlingen



ALPHABETISCHER INDEX

ALPHABETICAL INDEX

INDEX ALPHABÉTICO



www.Reda-Instrumente.de

- A**
- ABRAHAM, Tonsillennmesser287
- ABRAHAM, Tonsillenzange282
- Absaugrohr f. Laryngoskope338
- ACM-Kaltlichtkabeladapter20
- Adapter20
- Adapter Winter+IBE20
- Adapter, ACM20
- Adapter, Aesculap20
- Adapter, British20
- Adapter, Codman20
- Adapter, Comeg20
- Adapter, Dyonics20
- Adapter, Endoskope20
- Adapter, Fuji20
- Adapter, Heine20
- Adapter, Henke-Sass-Wolf20
- Adapter, HOUSE129
- Adapter, Kaltlichtkabel20
- Adapter, Lichtquellen20
- Adapter, Medicon20
- Adapter, MLW20
- Adapter, Olympus20
- Adapter, Pentax20
- Adapter, Stirnleuchte24, 25
- Adapter, Storz20
- Adapter, Volpi-Schölly-RFO20
- Adapter, Wolf20
- Adenotom, LAFORCE309
- ADSON, anatomische Pinzette97
- ADSON, chirurgische Pinzette97
- ADSON, Wundspreizer112
- ALDERDYCE, Tonsillendisektor290
- ALM, Wundspreizer110
- anatomische Pinzette, ADSON97
- anatomische Pinzette, McINDOE151
- anatomische Pinzette, POTTS-SMITH294
- anatomische Pinzette, SEMKEN95
- ANDERSON-NEIVERT, Osteotom233
- ANDREW, Zungendrucker269
- Antihaftpinzetten, bipolar40, 41
- Antrumhäkchen, PLESTER137
- Antrumküretten256, 257
- Antrumkürette, COAKLEY256
- Antrumkürette, FAULKNER256
- Antrumlöffel257
- Antrumraspel, WIENER238
- Antrumstanze184, 185
- Antrumstanze, OSTROEM184
- Arthroskop15
- ASCH, Septumrichtzange160
- AUFRICHT, Nasenhaken251
- AUFRICHT, Nasenraspel239
- Aufsatz, BARACANI354
- Aufsatz, BRUENINGS354
- Aufsatz, CORDES354
- Aufsatz, FRAENKEL354
- Aufsatz, KRAUSE354
- Aufsatz, LANGE354
- Aufsatz, SCHEINMANN354
- Aufsatz, SCHUMACHER354
- Aufsatz, SEIFERT354
- B**
- BABY-METZENBAUM, Supercutschere188
- BABY-WEBSTER, Nadelhalter209
- BABY-YANKAUER, Saugrohr284
- Ball, KABIERSKE60
- BALLENGER, Schwingmesser218
- BALLENGER, Septumelevatorium225
- BALLENGER, Tonsillenzange281
- BALLENGER-HAJEK, Septumelevatorium225
- BALLENGER-SLUDER, Tonsillotom305
- BANE-HARTMANN, Hohlmeißelzange106
- BARACANI, Aufsatz354
- BARANY, Lärmtrummel60
- BARBARA, Häkchen135, 136
- BARBARA, Nadel135
- BARNHILL, Ringmesser308
- BARON, Saugrohr128
- BARRAQUER, Mikro Nadelhalter123
- BARSKY, Wundhäkchen248
- BARTH, scharfer Löffel104
- Batteriegriffe332, 333
- BECKMANN, Ringmesser308
- BELLUCCI, Mikro Ohrschere80
- BERGMANN, Wundhäkchen250
- BEUSE, Face-Lift-Schere201
- BEYER, Hohlmeißelzange107
- Biegegerät, SCHUHKNACHT85
- BILLEAU, Ohrschlinge65
- Biopsie- u. Faßzange, Optiken15
- Biopsiestanze179
- Biopsiezange167
- bipolare Koagulationselektroden44, 45
- bipolare Pinzetten36-38, 41
- bipolare Saugpinzette42
- bipolare Stichkoagulationselektrode44
- bipolare Verbindungskabel39
- bipolare Pinzette, antihaf40, 41
- BLAKESLEY, Nasenzange164, 168, 180
- Blechscherer, UNIVERSAL118, 299
- Blepharoplastikschere, GREENBERG-PAR202
- Blepharoplastikschere, KAYE202
- BLOHMKE, Tonsillenzange281
- BLUMENTHAL, Hohlmeißelzange106
- Blutstillungsmeißel, PASSOW98, 235
- BOEHLER, Hohlmeißelzange107
- BOETTCHER, Tonsillenschere296
- Bohrer, HNO30, 31
- BOIES, Elevatorium226
- BONN, feine Schere192
- BOSE, Trachealhaken315
- BOSE, Trachealwundspreizer314
- BOUCHERON, Ohrspekula53
- BOWMAN, Sonde262, 293
- Brille, FRENZEL22
- Bronchoskop18
- Bronchoskopiezange, CHEVALIER-JACKSON356
- Bronchoskopiezange, JACKSON-CHEVALIER356
- BRUENINGS, Aufsatz354
- BRUENINGS, Ohrspekula55
- BRUENINGS, Septumzange158
- BRUENINGS, Tonsillennmesser287
- BRUENINGS, Tonsillenschnürer301
- BRUENINGS, Verlängerungsrohr354
- BRUENINGS, Zungenspatel268
- BRÜNING-SBRUNK, Wundhaken263
- BRÜNING-SLUCAS, Hohlmeißel98
- Bruststütze, Erwachsene335
- Bruststütze, Kinder335
- Bruststütze, LEWY336
- Bruststütze, NEGUS280
- BUCHWALD, Zungenspatel268
- BUCK, Fremdkörperzängchen73
- BUCK, Ohrkürette68, 69
- Bügel, McIVOR Mundsperrerr277
- C**
- CANFIELD, Tonsillennmesser287
- CAPLAN, Nasenschere206
- CARPENTER, Tonsillendisektor291

- CARPENTER,
Tonsillenenukleator.....291
- CASTROVIEJO,
Mikro Nadelhalter124
- CAWOOD-MINNESOTA,
Wangenhalter268
- CHEVALIER-JACKSON,
Bronchoskopiezange.....356
- CHEVALIER-JACKSON,
Trachealkanüle316
- chirurgische Pinzette.....95
- chirurgische Pinzette, ADSON.....97
- chirurgische Pinzette, GILLIES.....151
- chirurgische Pinzette, GRAEFE95
- chirurgische Pinzette,
POTTS-SMITH294
- chirurgische Pinzette,
SEMKEN95, 151
- chirurgische Pinzette,
STANDARD95
- chirurgische Schere,
STANDARD117
- CINELLI, Septummeißel.....232
- CITELLI, Stanze109
- CLAR, Stirnlampe.....26
- CLAUS, Tonsillennadel.....285
- CLAUS-KILLIAN,
Septummeißel236
- COAKLEY, Antrumkürette.....256
- COAKLEY, Trokar.....215
- COLLIN, Zungenzange.....270
- Columella-Pinzette, COTTLE153
- COLVER, Tonsillenzange281
- CONVERSE,
Nasenflügelhäkchen252
- CONVERSE, Nasenmesser217
- CONVERSE/WILMER/WALTER,
feine Schere194
- CORDES, Aufsatz354
- COTTLE, Columella-Pinzette153
- COTTLE, feine Schere194
- COTTLE, Fingerringhäkchen.....255
- COTTLE, Fixierpinzette94, 152
- COTTLE, Hammer.....102, 260
- COTTLE, Knorpelquetscher237
- COTTLE, Nasenflügelhäkchen
.....252, 253
- COTTLE, Nasenhaken251
- COTTLE, Nasenmesser217
- COTTLE, Nasenschere198
- COTTLE, Nasenspekula.....146, 147
- COTTLE, Osteotom.....100, 231
- COTTLE, Septumelevatorium
.....224, 225
- COTTLE, Septummeißel231
- COTTLE-JOSEPH,
Septumelevatorium.....224
- COTTLE-KAZANJIAN,
Knochensplitterzange.....108, 208
- COTTLE-MALTZ, Nasenraspel239
- COTTLE-MASING, Nasenschere.198
- COTTLE-NEIVERT,
Nasenflügelhäkchen.....252
- CRAIG, Septumzange.....158
- CRAIG-DOMNICK, Vomerzange..158
- CRILE-WOOD, Nadelhalter.....209
- Cystoskop.....16
- D**
- DAUBENSPECK, scharfer Löffel..258
- DAVIS-BOYLE, Mundsperrerr274
- DAVIS-BOYLE, Zungenspatel273
- DAVIS-MEYER, Mundsperrerr.....277
- DAY, Wundhäkchen.....66
- DEAN, Tonsillenschere.....296
- Deckelhalter, REICHERT343
- DENHART, Mundsperrerr271
- DENIS-BROWNE,
Tonsillenzange.....283
- DERF, Nadelhalter.....209
- DERLACKI,
Gehörknöchelpinzette.....97
- Dermatom, HUMBY.....221
- Dermatom, SCHINK220
- Dermatom, SILVER221
- Dermatom, WATSON221
- Diagnostik-Besteck.....48, 50-52
- DIETER, Hammerkopfstanze84
- Dilatator, LABORDE314
- Dilatator, RITTER-HALLE.....261
- Dilatator, TROUSSEAU.....314
- Dilatator, TROUSSEAU-BABY314
- DINGMAN, Nasenfeile.....130
- DINGMAN, Nasenraspel244
- DINGMANN, Mundsperrerr.....276
- DINGMANN, Zungendrücker.....276
- Dissektor, ALDERYCE.....290
- Dissektor, CARPENTER.....291
- Dissektor, FISCH.....93
- Dissektor, HENKE290
- Dissektor, HURD290
- Dissektor, LOPEZ-REINKE290
- DOUGHTY, Zugenspatel279
- DOYEN-JANSEN (MOLT),
Mundsperrerr271
- Draht f. Tonsillenschnürer.....302, 319
- Drahtbiegezüngchen, McGEE81
- SCHUHKNECHT81
- Drahtschere, UNIVERSAL....118, 299
- Drahtschlinge, Elektroden35
- Drahtschlingen.....163
- DUCKBILL, Ohrzüngchen75
- DUPLAY, Tupferzange.....295
- DUPUY-WEISS, Tonsillennadel....285
- E**
- EICKEN (KILLIAN) Spülkanüle.....212
- Einsteckkonus, POLITZER.....61
- Elektrode, Koagulation34, 35
- Elektrode, bipolar.....44
- Elektroden34, 35, 44
- Elektroden, monopolar34, 35
- Elektrodenballkoagulation35
- Elektrodendrahtschlinge.....35
- Elektrodenlanzette.....35
- Elektrodennadel Mini.....34, 35
- Elektrodennadel, monopolar35
- Elektrodenschlinge Mini.....34, 35
- Elevatorium.....138
- Elevatorium, BALLENGER.....225
- Elevatorium,
BALLENGER-HAJEK225
- Elevatorium, BOIES.....226
- Elevatorium, COTTLE224
- Elevatorium, COTTLE-JOSEPH..224
- Elevatorium, FREER91, 223
- Elevatorium, GOLDMANN.....226
- Elevatorium,
HAJEK-BALLENGER225
- Elevatorium, HALLE222
- Elevatorium, HENKE290
- Elevatorium, HOWARTH.....224
- Elevatorium, JOSEPH.....222
- Elevatorium, JOSEPH-COTTLE..224
- Elevatorium, KILLIAN223, 225
- Elevatorium, LEMPERT.....88
- Elevatorium, MASING222
- Elevatorium, McKENTY..92, 222, 224
- Elevatorium, PENNINGTON.....224
- Elevatorium, PIERCE223
- Elevatorium, QUERVAIN.....86
- Elevatorium, ROGER222
- Elevatorium, SEBILEAU.....86
- Elevatorium, SEWALL.....226

- Elevatorium, SINUS.....223
 Elevatorium, YANKAUER290
 Endoskope.....14-18
 E nukleator, CARPENTER291
 Ersatzflasche, KABIERSKE.....60
 Ersatzklinge, Dermatome220, 221
 Ersatzklängen, LAFORCE309
 Ersatzlämpchen..22, 26, 27, 332, 333
 Ersatzlämpchen f. FRENZEL22
 EVES, Tonsillenschnürer301
- F**
- Face-Lift-Schere, BEUSE.....201
 Face-Lift-Schere, GORNEY200
 Face-Lift-Schere,
 GORNEY-FREEMAN200
 Face-Lift-Schere, KAYE201
 Face-Lift-Schere,
 PECK-JOSEPH201
 Fadengabel, Laryngoskopie352
 Fadengabel, NEGUS.....304
 Fadenschere, LITTAUER199
 Fadenschere, O'BRIEN199
 Fadenschere, SPENCER199
 FARABEUF, Raspatorium.....90
 FARRELL, Watteträger63
 FARRIOR, Ohrspekula54
 Faßzängchen, GREVEN81
 Faßzängchen, Mikro78
 Faßzange, Kieferhöhle176, 177
 Faßzange, LAHEY.....318
 Faßzange f. Optiken15
 FAULKNER, Antrumkürette256
 Feile, DINGMAN.....130
 FEIN, Kehlkopfwatteträger347
 feine Schere, BONN192
 feine Schere,
 CONVERSE/WILMER/WALTER ..194
 feine Schere, COTTLE194
 feine Schere, GRADLE.....195
 feine Schere, GRAEFE.....194
 feine Schere, IRIS117, 192
 feine Schere, JOSEPH.....116, 190
 feine Schere, KILNER
 (RAGNELL)191
 feine Schere, KNAPP193
 feine Schere, LITTLER.....194
 feine Schere, SANVENERO.....190
 feine Schere, STEVENS.....196
 feine Schere,
 STRABISMUS116, 196
 feine Schere, WAGNER197
- feine Schere, WALTER/
 WILMER/CONVERSE194
 FERGUSSON, Saugrohr213
 FERGUSSON/FRAZIER,
 Saugrohr.....125, 213
 FERRIS-SMITH-KERRISON,
 Stanze181
 Fiberglas-Kaltlichtkabel19
 Fiberglas-Lichtträger.....337, 338
 Fingerringhäkchen, COTTLE.....255
 FINSEN, Wundspreizer110
 FISCH, Dissektor.....93
 FISCH, Mikro Ohrschere82
 FISCH, Wundspreizer.....112, 265
 FISHER, Tonsillennmesser.....286
 Fixierpinzette, COTTLE94, 152
 Fixierpinzette, GRAEFE95, 151
 Fixiervorrichtung, YASARGIL57
 Flachmeißel.....98, 99
 Flachmeißel, PARTSCH99
 Flachmeißel, WALTER235
 flexibler Spannarm, YASARGIL.....57
 FOMON, Nasenflügelhäkchen.....253
 FOMON, Nasenraspel240, 241
 FOMON, Nasenschere198
 FOMON, Septumosteotom232
 FRAENKEL, Aufsatz354
 FRAENKEL, Kehlkopfzange.....342
 FRAZIER, Wundhäkchen246
 FRAZIER/FERGUSSON,
 Saugrohr.....125, 213
 FREER, Septumelevatorium ..91, 223
 FREER, Septummeißel
100, 230, 236
 FREER, Septummesser216
 FREER, Wundhäkchen254
 FREER-INGALS,
 Submukosamesser.....219
 Fremdkörperhebel, QUIRE.....73
 Fremdkörperzängchen, BUCK73
 Fremdkörperzängchen,
 HARTMANN75
 Fremdkörperzängchen,
 HARTMANN-HOFFMANN.....75, 175
 Fremdkörperzängchen,
 HARTMANN-WEINGÄRTNER75
 Fremdkörperzängchen,
 HARTMANN-WULLSTEIN75, 175
 Fremdkörperzängchen,
 STRUEMPEL.....75
 FRENZEL, Nystagmus Brille22
 FRENZEL, Zungenspatel268
- FROHN, Watteträger63
 FRONTAL, Nasensonde.....261
 Führungsgabel, PLESTER137
 FUJI-Kaltlichtkabeladapter20
 Fußplattenhäkchen, PLESTER137
- G**
- GALLAHER, Nasenraspel243
 Gaumenplatte, DAVIS-MEYER277
 Gehörknöchelpinzette,
 DERLACKI.....97
 Gelenk, Bruststütze335
 Gelenkkloben, LEYLA.....148
 GERZOG, Hammer259
 GILLIES, chirurgische Pinzette.....151
 GILLIES, Wundhäkchen254
 GLABELLA, Nasenraspel238
 GOLDMANN,
 Septumelevatorium.....226
 GOOD, Tonsillenschere296
 GORNEY, Face-Lift-Schere.....200
 GORNEY, Präparierschere.....116
 GORNEY-FREEMAN,
 Face-Lift-Schere200
 GRADLE, feine Schere.....195
 GRAEFE, chirurgische Pinzette95
 GRAEFE, feine Schere194
 GRAEFE, Fixierpinzette95, 151
 GRAEFE, Wundhäkchen246
 GREENBERG-PAR,
 Blepharoplastikschere202
 GREVEN, Faßzängchen81
 Griff, HUBER354
 Griff, Kaltlicht332
 Griff, Kehlkopfspiegel346
 Griff, Laryngoskop336
 Griff, Warmlicht333
 Griff, WULLSTEIN127, 129
 GROSS, Ohrkürette.....65
 GROSS, Ohrlöf u. -Häkchen.....65
 GRUBER, Ohrspekula.....53
 GUILLEN, Saugraspatorium.....227
 Gummibirne, POLITZER61
 GUTHRIE, Wundhäkchen246
- H**
- HAJEK, Hammer102
 HAJEK, Septummeißel.....236
 HAJEK-BALLENGER,
 Septumelevatorium.....225
 HAJEK-KOFLER, Stanze182, 183
 Häkchen25, 66, 135-137, 246-250

Häkchen, BARBARA	135, 136	Hammer, HAJEK	102	Hohlmeißelzange, BOEHLER	107
Häkchen, BARSKY	248	Hammer, MEAD	102, 259	Hohlmeißelzange, KLEINERT-KUTZ	107
Häkchen, BERGMANN	250	Hammer, PARTSCH	102, 260	Hohlmeißelzange, LEMPERT	107
Häkchen, CONVERSE	252	Hammer, QUISLING	260	Hohlmeißelzange, LUER	106
Häkchen, COTTLE	252-255	Hammerkopfstanze, DIETER	84	Hohlmeißelzange, ZAUFAL-JANSEN	107
Häkchen, COTTLE-NEIVERT	252	Handgriff f. Laryngoskope	336	HOLINGER, Laryngoskop	339
Häkchen, DAY	66	Handgriff f. Stabinstrumente, Laryngoskopie	353	HOLZHEIMER, Wundspreizer	110
Häkchen, FOMON	253	HARTMANN, Fremdkörperzängchen	75	Holzspatel	268
Häkchen, FRAZIER	246	HARTMANN, Nasenspekula	142	HOUSE, Mikro Kürette	133
Häkchen, FREER	254	HARTMANN, Nasentamponzange	154	HOUSE, Mikro Meßsonde	132
Häkchen, GILLIES	254	HARTMANN, Ohrkatheter	70	HOUSE, Saugadapter	129
Häkchen, GRAEFE	246	HARTMANN, Ohrspekula	53	HOUSE, Saugrohr	126, 214
Häkchen, GROSS	65	HARTMANN, Ohrzängchen	74	HOUSE-GELFOAM, Quetschzange	85
Häkchen, GUTHRIE	246	HARTMANN, scharfe Nasenzange	169	HOWARTH, Septumelevatorium	224
Häkchen, HUMBY	248	HARTMANN, Stimmgabel	58	HUBER, Universalgriff	354
Häkchen, JOSEPH	247	HARTMANN, Tonsillenzange	307	HUMBY, Dermatome	221
Häkchen, KILNER	253	HARTMANN, Zungendrücker	269	HUMBY, Wundhäkchen	248
Häkchen, KLEINERT-KUTZ	247	HARTMANN-HALLE, Nasenspekula	141	HURD, Tonsillendisektor	290
Häkchen, KNAPP	250	HARTMANN-HOFFMANN, Fremdkörperzängchen	75, 175		
Häkchen, Knopf	66	HARTMANN-WEINGÄRTNER, Fremdkörperzängchen	75	I	
Häkchen, LAHEY	246	HARTMANN-WULLSTEIN, Fremdkörperzängchen	75, 175	IBE+Winter, Adapter	20
Häkchen, LANGE	255	Hebel, QUIRE	73	Injektionskanüle	337, 349
Häkchen, Laryngoskopie	352	Hebel, ZAUFAL-JANSEN	65	IRIS, feine Schere	117, 192
Häkchen, LUCAE	66, 250	Hebel, ZUFAL	65	ITERSON, Trachealhaken	315
Häkchen, McGEE	136	HEINE-Kaltlichtkabeladapter	20		
Häkchen Mikro, Laryngoskopie	353	HEISTER, Mundsperrerr	271	J	
Häkchen, NEIVERT-COTTLE	252	HENKE, Tonsillendisektor	290	JACKSON, Kehlkopfpinzette	343
Häkchen, PLESTER	137	HENKE, Tonsillenelevatorium	290	JACKSON, Laryngoskope	340
Häkchen, REDA	249	HEYMANN, Nasenschere	198	JACKSON, Trachealhaken	314
Häkchen, ROLLET	250	HEYMANN, Septumzange	157	JACKSON-CHEVALIER, Bronchoskopiezange	356
Häkchen, SHAMBAUGH	135	HEYMANN-KNIGHT, Polypenzange	156	JAMESON-REYNOLDS, Schere	191
Häkchen, TYRELL	246	HNO-Bohrer	30, 31	JANSEN, Nasentamponpinzette	150
Häkchen, WAGENER	66	HNO-Stirnleuchte	25	JANSEN, Raspatorium	91
Häkchen, WILLIGER	114	HOFER, Wundhaken	289	JANSEN, scharfer Löffel	103
Haken, AUFRICHT	251	Hohlmeißel	98, 99	JANSEN, Wundspreizer	110
Haken, BOSE	315	Hohlmeißel, BRÜNNINGS-LUCAS	98	JANSEN-MIDDLETON, Septumzange	159
Haken, COTTLE	251	Hohlmeißel, FREER	236	JANSEN-ZAUFAL, Ohrhebel	65
Haken, ITERSON	315	Hohlmeißel, LEXER MINI	100	JATHO, Nasenrachenzange	310
Haken, JACKSON	314	Hohlmeißel, PARTSCH	99	JENNINGS, Mundsperrerr	271
Haken, MASING	251	Hohlmeißelzange, BANE-HARTMANN	106	JOBSON-HORNE, Watteträger	64
Haken, MASING-NEIVERT	251	Hohlmeißelzange, BEYER	107	JOSEPH (LEWIS), Nasenraspel	239
Haken, NEIVERT-MASING	251	Hohlmeißelzange, BLUMENTHAL	106	JOSEPH, Elevatorium	222
Haken, NEWS	315			JOSEPH, feine Schere	116, 190
Haken, SCHOENBORN	317			JOSEPH, Nasenmesser	216, 217
HALLE, scharfer Löffel	104, 258			JOSEPH, Nasenraspel	238
HALLE, Septumelevatorium	222			JOSEPH, Nasensäge	244, 245
HALLE-RITTER, Nasensonde	261			JOSEPH, Raspatorium	88
HALSEY, Nadelhalter	209				
Haltearm, LEYLA	148				
Hammer	102, 259, 260				
Hammer, COTTLE	102, 260				
Hammer, GERZOG	259				

JOSEPH, Wundhäkchen	247	KILLIAN, Kehlkopfwatteträger	347	KRAUSE, Aufsatz	354
JOSEPH-COTTLE, Septumlevatorium.....	224	KILLIAN, Nasenspekula	144, 145	KRAUSE, Polypenschnürer.....	72, 162
JURASZ, Kehlkopfzange.....	342	KILLIAN, Septumlevatorium	223, 225	KRAUSE-VOSS, Polypenschnürer.....	162
JURASZ, Nasenrachenzange	311	KILLIAN, Spülkanüle	212	KROENIG, Zungenspatel	268
K		KILLIAN-CLAUS, Septummeißel.....	236	Kropfsonde, LAHEY	318
Kabel, bipolar.....	39	KILLIAN-EICKEN, Spülkanüle.....	212	Kropfsonde, KOCHER.....	317
KABIERSKE, Ersatzflasche.....	60	KILNER (RAGNELL), feine Schere	191	Kugelelektrode.....	35
KABIERSKE, Ohrkanüle.....	60	KILNER, Nasenflügelhäkchen	253	Kugelenkklöben, LEYLA	148
KABIERSKE, Pulverbläser	60	KILNER-DOUGHTY, Mundsperrer	275	Kupplungskopf, LEYLA.....	148
KABIERSKE, Ventilball.....	60	KLEINERT-KUTZ, Hohlmeißelzange.....	107	Kürette, Antrum.....	256, 257
Kaltlichtkabel, Fiberglas.....	19	KLEINERT-KUTZ, Wundhäkchen.....	247	Kürette, BUCK.....	68, 69
Kaltlichtgriff	332	Kleintransformator	26	Kürette, COAKLEY	256
Kaltlichtkabeladapter	20	Klemme, BOETTCHER (SCHNIDT)	281	Kürette, FAULKNER	256
Kaltlichtkabeladapter, ACM.....	20	Klemme, MASTIN.....	318	Küretten, HOUSE	133
Kaltlichtkabeladapter, Fuji.....	20	Klemme, MIKULICZ.....	283	L	
Kaltlichtkabeladapter, Heine.....	20	Klemme, NEGUS.....	281	LABORDE, Trachealdilatator.....	314
Kaltlichtkabeladapter, MLW	20	Klemme, NEGUS.....	281	LAFORCE, Adenotom	309
Kaltlichtkabeladapter, Olympus	20	Klemme, SAWTELL.....	281	LAHEY, Kropfpaßzange.....	318
Kaltlichtkabeladapter, Pentax	20	Klemme, SCHNIDT	281	LAHEY, Wundhäkchen	246
Kaltlichtkabeladapter, Wolf	20	Klemme, SCHNIDT (BOETTCHER).....	281	LAMBOTTE Mini, Osteotom	99, 229
Kanüle, CHEVALIER-JACKSON	316	KNAPP, feine Schere.....	193	Lämpchen.....	22, 26, 27, 332, 333
Kanüle, EICKEN (KILLIAN)	212	KNAPP, Wundhäkchen.....	250	LANGE, Aufsatz.....	354
Kanüle, Injektion	337, 349	KNIGHT, Septumzange	157	LANGE, Nasenflügelhäkchen.....	255
Kanüle, Kehlkopf	210, 306, 344	Knochendraht	302	LANGENBECK, Ohrschlinge.....	65
Kanüle, KILLIAN	212	Knochensplitterzange, COTTLE-KAZANJIAN	108, 208	LANGENBECK, Raspatorium.....	86
Kanüle, KILLIAN-EICKEN	212	Knochensplitterzange, McINDOE	108, 208	Lanzette, Elektrode.....	35
Kanüle, LUER.....	316	Knochenstanze, CITELLI.....	109	Lanzettenmesser, ROSEN	121
Kanüle, Mikro.....	125, 127	Knochenstanze, FERRIS-SMITH-KERRISON	181	Laparoskop.....	18
Kanüle, Ohr, KABIERSKE	60	Knochenstanze, KERRISON	109	Lärmtrommel, BARANY.....	60
Kanüle, ROSEN.....	129	Knorpelhäkchen.....	66	Laryngoskop, HOLINGER	339
Kanüle, Septum.....	210, 306, 344	Knorpelkeile, DINGMAN.....	130	Laryngoskop, JACKSON.....	340
Kanüle, WAGENER-MOSHER.....	315	Knorpelquetscher, COTTLE	237	Laryngoskope .. 17, 334-336, 339-341	
Katheter, HARTMANN.....	70	Knorpelritzmesser, MASING.....	219	Laryngoskope Handgriff	336
KAYE, Blepharoplastikschere.....	202	Koagulationselektrode, bipolar	44, 45	Laryngoskopie Instrumente	352, 353
KAYE, Face-Lift-Schere	201	Koagulationselektrode Mini	35	Laryngoskopie, Injektionskanüle	337
Kehlideckelhalter, REICHERT	343	Koagulationssaugrohr.....	211, 348	Laryngoskopie, Nadelhalter	349
Kehlkopfkanüle.....	210, 306, 344	KOCHER, Kropfsonde.....	317	Laryngoskop-Optik	17
Kehlkopfpinzette, JACKSON.....	343	KOCHER-LANGENBECK, Wundhaken	263	Laryngoskop-Set .. 322, 325, 327, 329	
Kehlkopfpolypenschnürer	319	KOENIG, Raspatorium	86	Laryngoskop-Spatel, McCOY	324, 331
Kehlkopfschere, KILLIAN	343	KOFLER-HAJEK, Stanze	182	Laryngoskop-Spatel, McINTOSH	323, 328
Kehlkopfspiegel	346	Kornzange	295	Laryngoskop-Spatel, MILLER	326, 330
Kehlkopfspiegel, MICHEL.....	345	Kornzange, DUPLAY	295	LED-Stirnlampe	27
Kehlkopfwatteträger, FEIN.....	347			LEMPERT, Elevatorium	88
Kehlkopfwatteträger, KILLIAN	347			LEMPERT, Hohlmeißelzange	107
Kehlkopfzange, FRAENKEL.....	342			LEMPERT, Raspatorium.....	88, 91
Kehlkopfzange, JURASZ.....	342			LEMPERT, scharfer Löffel	103
KELLY, Präparierschere	191			Leuchtklammer	338, 341
KERRISON, Stanze.....	109, 182				
Kieferhöhlenfaßzange	176, 177				
KILLIAN, Kehlkopfschere	343				

LEWIS-JOSEPH, Nasenraspel.....	239	M	Messer, FREER.....	216
LEWY, Bruststütze.....	336	MALTZ (COTTLE), Nasenraspel ..	Messer, FREER-INGALS	219
LEXER Mini, Hohlmeißel.....	100	MALTZ, Nasenraspel.....	Messer, JOSEPH.....	216, 217
LEXER Mini, Osteotom.....	100	MARSCHIK, Tonsillenzange.....	Messer, MASING.....	219
LEXER, Osteotom.....	100, 228	MARTIN, Verbindungskabel,	Messer Mikro,	
LEYLA, Gelenkkloben.....	148	bipolar.....	Laryngoskopie.....	352, 353
LEYLA, Haltearm.....	148	MARTINI, scharfer Löffel.....	Messer, PLESTER.....	122
LEYLA, Kugelgelenkkloben.....	148	MASING, Elevatorium.....	Messer, POLITZER.....	71
LEYLA, Kupplungskopf.....	148	MASING, Knorpelritzmesser.....	Messer, REDA.....	217
Lichtträger, Fiberglas.....	337, 338	MASING, Nasenhaken.....	Messer, ROSEN.....	120, 121
LICHTWITZ, Trokar.....	215	MASING, Nasenraspel.....	Messer, SCHUKNECHT.....	122
LINDEMANN, Nasensäge.....	245	MASING-NEIVERT,	Messer, SEXTON.....	71
Lippenhalter.....	270	Nasenhaken.....	Messer, St. CLAIR-THOMSON	309
LISTER (Sinus), Tamponzange.....	155	MASTIN, Muskelklemme.....	Messer, TABB.....	122
LITTAUER, Fadenschere.....	199	MAUNDER, Mundkeil.....	Messer, WULLSTEIN.....	122
LITTAUER, Ohrzängchen.....	74	MAY, Ophthalmoskop.....	Meßsonde Mikro, HOUSE.....	132
LITTAUER, Polypenzange.....	156	McCOY,	METZENBAUM,	
LITTLER, feine Schere.....	194	Laryngoskopspatel.....	Präparierschere.....	115, 188, 189, 297
Löffel.....	138	McGEE, Drahtbiegezängchen.....	MICHEL, Kehlkopfspiegel.....	345
Löffel, Antrum.....	257	McGEE, Häkchen.....	MICRODOME,	
Löffel, BARTH.....	104	McINDOE,	Koagulationselektrode bipolar.....	45
Löffel, DAUBENSPECK.....	258	anatomische Pinzette.....	MIDDELDORPF, Wundhaken.....	263
Löffel, GROSS.....	65	McINDOE,	MIDDLETON-JANSEN,	
Löffel, HALLE.....	104, 258	Knochensplitterzange.....	Septumzange.....	159
Löffel, JANSEN.....	103	McINTOSH, Laryngoskop-Set.....	Mikro Faßzängchen.....	78
Löffel, LEMPERT.....	103	327	Mikro Häkchen, Laryngoskopie.....	353
Löffel, MARTINI.....	105	McINTOSH,	Mikro Löffelzängchen,	
Löffel, SHEA.....	134	Laryngoskopspatel.....	WULLSTEIN.....	79
Löffel, SPRATT.....	103	McIVOR, Mundsperrerr.....	Mikro Löffelzange.....	131
Löffel, VOLKMANN.....	104	McIVOR, Zungenspatel.....	Mikro Messer, Laryngoskopie.....	353
Löffel, WILLIGER.....	105	McKENTY,	Mikro Nadelhalter,	
Löffelzängchen Mikro,		Septumelevatorium.....	BARRAQUER.....	123
WULLSTEIN.....	79	MEAD, Hammer.....	Mikro Nadelhalter,	
Löffelzange Mikro.....	131	Meißel.....	CASTROVIEJO.....	124
LOPEZ-REINKE,		Meißel, CINELLI.....	Mikro Nadelhalter, TITAN.....	123
Tonsillendissektor.....	290	Meißel, CLAUS-KILLIAN.....	Mikro Ohrscherchen,	
LOTHROP, Uvulahaken.....	288	Meißel, FREER.....	WULLSTEIN.....	83
LOVE, Uvulahaken.....	288	Meißel, HAJEK.....	Mikro Ohrscherre, BELLUCCI.....	80
LUBET-BARBON,		Meißel, KILLIAN-CLAUS.....	Mikro Ohrscherre, SHEA.....	80
Nasentamponzange.....	154	Meißel, PASSOW.....	Mikro Ohrscheren.....	80, 82, 83, 131
LUC, Siebbeinzange.....	157	Meißel, SILVER.....	Mikro Ohrzängchen.....	76, 77
LUCAE, Ohr-Nasen-Pinzette..	94, 152	Meißel, WALTER.....	Mikro Ohrzange.....	131
LUCAE, Stimmgabel.....	59	Meißel, WEST.....	Mikro Rohrschaftzange.....	350, 351
LUCAE, Trommelfellnadel.....	70	Messer, ABRAHAM.....	Mikro Sichelmesser,	
LUCAE, Wundhäkchen.....	66, 250	Messer, BALLENGER.....	Laryngoskopie.....	352
LUER, Hohlmeißelzange.....	106	Messer, BARNHILL.....	Mikro Kürette, HOUSE.....	133
LUER, Trachealkanüle.....	316	Messer, BECKMANN.....	Mikro Meßsonde, HOUSE.....	132
Luftdusche, POLITZER.....	61	Messer, BRUENINGS.....	Mikro Ohrzängchen.....	75-81
LUNIATSCHEK, Tamponstopfer ..	292	Messer, CANFIELD.....	Mikro Saugkanüle.....	125, 127
Lupe, BRUENINGS.....	55	Messer, CONVERSE.....	Mikro Schere, REDA.....	203
		Messer, COTTLE.....	Mikro Scheren.....	119, 203-205
		Messer, FISHER.....	Mikro Scheren, TITAN.....	203-205

MIKULICZ, Tonsillenklemme	283	Nasenhäkchen, CONVERSE	252	Nasenschere, HEYMANN	198
MILLER, Laryngoskop-Set ...	325, 329	Nasenhäkchen, COTTLE	252-254	Nasensonde, FRONTAL	261
MILLER, Laryngoskopspatel		Nasenhäkchen,		Nasensonde, RITTER-HALLE	261
.....	326, 330	COTTLE-NEIVERT	252	Nasensonde, SINUS	261
MILLER, Raspatorium	92	Nasenhäkchen, FOMON	253	Nasensonde, WILDER	261
Miniatur-Stirnleuchte	23	Nasenhäkchen, KILNER	253	Nasenspekula	140-147
MINI-LAMBOTTE, Osteotom ..	99, 229	Nasenhäkchen, LANGE	255	Nasenspekula, COTTLE	146, 147
MLW-Kaltlichtkabeladapter	20	Nasenhäkchen,		Nasenspekula, HARTMANN	142
Mod. VIENNA, Nasenspekula	143	NEIVERT-COTTLE	252	Nasenspekula,	
MOLLISON, Wundspreizer	112	Nasenhaken, AUFRICHT	251	HARTMANN-HALLE	141
MOLT, Mundsperrerr	271	Nasenhaken, COTTLE	251	Nasenspekula, KILLIAN	144, 145
MOLT, Raspatorium	92	Nasenhaken,		Nasenspekula, REDA	144
MORITZ-SCHMIDT,		MASING-NEIVERT	251	Nasenspekula, THUDICHUM	140
Zungendrücker	269	Nasenhaken,		Nasenspekula, TIECK-HALLE	144
Mundkeil, MAUNDER	280	NEIVERT-MASING	251	Nasenspekula, VIENNA	143
Mundsperrerr, DAVIS-BOYLE	274	Nasenmesser, CONVERSE	217	Nasenspekula, VOLTOLINI	140
Mundsperrerr, DAVIS-MEYER	277	Nasenmesser, COTTLE	217	Nasentamponzange,	
Mundsperrerr, DENHART	271	Nasenmesser, JOSEPH	216, 217	HARTMANN	154
Mundsperrerr, DINGMANN	276	Nasen-Ohr-Pinzette, LUCAE ..	94, 152	Nasentamponzange,	
Mundsperrerr, DOYEN-JANSEN ..	271	Nasenolive, POLITZER	61	LUBET-BARBON	154
Mundsperrerr, HEISTER	271	Nasenpinzette, LUCAE	94, 152	Nasentamponzange,	
Mundsperrerr, JENNINGS	271	Nasenpinzette,		WESTMACOTT	154
Mundsperrerr,		TROELTSCH-WILDE	94, 152	Nasentamponzinzette, JANSEN ..	150
KILNER-DOUGHTY	275	Nasenpinzette, WILDE		Nasentamponzinzette,	
Mundsperrerr, McIVOR	277	(TROELTSCH)	94, 152	TROELTSCH	149
Mundsperrerr, MOLT	271	Nasentrachenzange, JATHO	310	Nasenzange, ASCH	160
Mundsperrerr, ROSER-KOENIG ..	271	Nasentrachenzange, JURASZ	311	Nasenzange, Biopsie	167
Muskelklemme, MASTIN	318	Nasentrachenzange,		Nasenzange, BLAKESLEY ..	164, 168
		St. CLAIR-THOMSON	310	Nasenzange, durchschneidend ..	178
		Nasentrassel, MALTZ (COTTLE) ..	239	Nasenzange, HARTMANN	169
		Nasentrassel, (JOSEPH (LEWIS) ..	239	Nasenzange, SCHMEDEN	169
		Nasentrassel, AUFRICHT	239	Nasenzange, STRUYCKEN	169
		Nasentrassel, COTTLE-MALTZ ..	239	Nasenzange, TAKAHASHI	165
		Nasentrassel, DINGMAN	244	Nasenzange, WALSHAM	160
		Nasentrassel, FOMON	240, 241	Nasenzange,	
		Nasentrassel, GALLAHER	243	WATSON-WILLIAMS	166
		Nasentrassel, GLABELLA	238	Nasenzange,	
		Nasentrassel, JOSEPH	238	WEIL-BLAKESLEY	164, 168
		Nasentrassel, LEWIS-JOSEPH ..	239	Nasenzangen	169-174
		Nasentrassel, MALTZ	238	Nasopharyngo-Laryngoskop	14
		Nasentrassel, MASING	242	NEGUS, Bruststütze	280
		Nasentrassel, PARKES	238	NEGUS, Fadengabel	304
		Nasensäge, JOSEPH	244, 245	NEGUS, Tonsillenklemme	281
		Nasensäge, LINDEMANN	245	NEIVERT-ANDERSON,	
		Nasenschere, CAPLAN	206	Osteotom	233
		Nasenschere,		NEIVERT-COTTLE,	
		COTTLE-MASING	198	Nasenflügelhäkchen	252
		Nasenschere,		NEIVERT-MASING,	
		MASING-COTTLE	198	Nasenhaken	251
		Nasenscheren	187	NEWS, Trachealhaken	315
		Nasenschere, COTTLE	198	Non-Stick, Saugkoagulator,	
		Nasenschere, FOMON	198	monopolar	43

NOYES, Polypenzange	155	Ohrzängchen, WULLSTEIN	79	Pinzette, JANSEN	150
Nystagmus Brille, FRENZEL	22	Ohrzange Mikro	131	Pinzette, LUCAE.....	94, 152
O		Olympus-Kaltlichtkabeladapter	20	Pinzette, McINDOE	151
O'BRIEN, Fadenschere	199	Ophthalmologie Schere	195	Pinzette, POTTS-SMITH	294
OBWEGESER, Osteotom	234	Ophthalmoskop, MAY	49	Pinzette, SEMKEN	95, 151
Ohrhäkchen	66	Ophthalmoskop, UNI II	49	Pinzette, TROELTSCH	149
Ohrhäkchen, DAY	66	OP-Laryngoskope.....	334-336, 341	Pinzette, TROELTSCH-WILDE	94, 152
Ohrhäkchen, GROSS	65	Osteotom	98	Pinzette, WILDE (TROELTSCH).....	94, 152
Ohrhäkchen, WAGENER	66	Osteotom, ANDERSON-NEIVERT	233	Pinzette, bipolar.....	36-38, 40, 41
Ohrhebel, JANSEN-ZAUFAL.....	65	Osteotom, COTTLE.....	100, 231	Pinzette, COTTLE	94, 152, 153
Ohrhebel, ZAUFAL	65	Osteotom, FOMON.....	232	Pinzette, Uhrmacher.....	96
Ohrhebel, ZAUFAL-JANSEN.....	65	Osteotom, LEXER	228	PLESTER, Antrumhäkchen	137
Ohrkanüle, KABIERSKE.....	60	Osteotom, LEXER MINI.....	100	PLESTER, Führungsgabel	137
Ohrkatheter, HARTMANN	70	Osteotom, MINI-LAMBOTTE	99, 229	PLESTER, Fußplattenhäkchen	137
Ohrkürette, BUCK.....	68, 69	Osteotom, NEIVERT-ANDERSON.....	233	PLESTER, Rundmesser	122
Ohrkürette, GROSS.....	65	Osteotom, OBWEGESER	234	PLESTER, Saugrohr	126
Ohröffel, GROSS	65	Osteotom, RUBIN.....	234	PLESTER, Schaber.....	137
Ohrmesser, POLITZER	71	Osteotom, SHEEHAN.....	101, 232	PLESTER, Wundspreizer	113, 264
Ohrmesser, SEXTON	71	OSTROEM, Antrumstanze	184	POLITZER, Einsteckkonus.....	61
Ohr-Nasen-Pinzette, LUCAE	94, 152	Otoskop	17, 48	POLITZER, Gummibirne	61
Ohrolive, POLITZER.....	61	Otoskop, Diagnostik-Besteck UNI I.....	48	POLITZER, Luftdusche	61
Ohrpinzette, TROELTSCH-WILDE	94, 152	Otoskop, Diagnostik-Besteck UNI III.....	50	POLITZER, Nasenolive	61
Ohrpinzette, WILDE (TROELTSCH)	94, 152	P		POLITZER, Ohrmesser	71
Ohrscherer Mikro, BELLUCCI	80	PARKES, Nasenraspel	238	POLITZER, Ohrspekula.....	53
Ohrscherer Mikro, SHEA	80	PARTSCH, Flachmeißel	99	POLITZER, Trommelfellnadel.....	70, 71
Ohrscherer, FISCH.....	82	PARTSCH, Hammer.....	102, 260	Polypenschnürer, Kehlkopf.....	319
Ohrscheren Mikro.....	80, 82, 83, 131	PARTSCH, Hohlmeißel	99	Polypenschnürer, KRAUSE	72, 162
Ohrschlinge, BILLEAU.....	65	PASSOW, Blutstillungsmeißel.....	98, 235	Polypenschnürer, KRAUSE-VOSS.....	162
Ohrschlinge, LANGENBECK.....	65	PECK-JOSEPH, Face-Lift-Schere	201	Polypenschnürer, VOSS-KRAUSE.....	162
Ohrschlinge, SHAPLEIGH.....	67	PEET, Nasenraspel	238	Polypenschnürer, WILDE	72, 163
Ohrschlinge, WEBER-LOCH.....	67	PENNINGTON, Septumelevatorium.....	224	Polypenzange, FRAENKEL.....	342
Ohrsonde, STACHE.....	63	Pentax-Kaltlichtkabeladapter	20	Polypenzange, JURASZ.....	342
Ohrspekula, BRUENINGS.....	55	PERWITZSCHKY, Speichelgangschere	298	Polypenzange, KEYMANN-KNIGHT	156
Ohrspekula, FARRIOR.....	54	Pharyngoskop.....	16	Polypenzange, LITTAUER.....	156
Ohrspekula, GRUBER.....	53	PIERCE, Septumelevatorium	223	Polypenzange, NOYES	155
Ohrspekula, HARTMANN.....	53	Pinzette, ADSON	97	POTTS-SMITH, anatomische Pinzette	294
Ohrspekula, POLITZER.....	53	Pinzette, anatomisch	95	POTTS-SMITH, chirurgische Pinzette	294
Ohrspekula, SIEGLE	56	Pinzette, chirurgisch	95	Präparierschere, GORNEY	116
Ohrspekula, TOYNBEE	53	Pinzette, COTTLE	153	Präparierschere, KELLY	191
Ohrspekula, BOUCHERON.....	53	Pinzette, DERLACKI.....	97	Präparierschere, METZENBAUM	115, 188, 189, 297
Ohrspekulahalter, YASARGIL.....	57	Pinzette, GILLIES.....	151	Präparierschere, REYNOLDS (JAMESON).....	191
Ohrspritze	61, 62	Pinzette, GRAEFE.....	95, 151	PRINCE, Tonsillenschere	296
Ohrspritze, REINER	61	Pinzette, JACKSON.....	343		
Ohrspritze, selbstfüllend.....	62				
Ohrtrichterhalter, YASARGIL.....	57				
Ohrzängchen Mikro	75-81				
Ohrzängchen, DUCKBILL	75				
Ohrzängchen, HARTMANN.....	74				
Ohrzängchen, LITTAUER.....	74				

Pulverbläser, KABIERSKE	60	REDA, Wundhäkchen.....	249	Saugrohr, HOUSE	126, 214
Pulverbläser, UNIVERSAL	60	REICHERT, Kehldeckelhalter	343	Saugrohr, Koagulation.....	211, 348
Q		REINER, Ohrspritze	61	Saugrohr, PLESTER.....	126
QUERVAIN, Elevatorium	86	REYNOLDS (JAMESON),		Saugrohr, ROSEN	129
Quetschzange,		Präparierschere.....	191	Saugrohr, WULLSTEIN	127
HOUSE-GELFOAM.....	85	RFO-Schölly-Volpi, Adapter.....	20	Saugrohr, YANKAUER	284
Quetschzange, RUBIN.....	161	Ring f. Bruststütze	335	Saugrohr, ZÖLLNER	125
QUIRE, Fremdkörperhebel.....	73	RING, Zungenspatel.....	272	Saugrohre.....	125-129
QUISLING, Hammer.....	260	RINGMESSER, BARNHILL.....	308	SAWTELL, Tonsillenklemme	281
R		Ringmesser, BECKMANN	308	Schaber, PLESTER.....	137
RAGNELL-KILNER,		Ringmesser,		Schälmesser Mikro,	
feine Schere	191	St. CLAIR-THOMSON.....	309	Laryngoskopie	352
Rasierklingen.....	221	RITTER-HALLE, Nasensonde.....	261	scharfe Nasenzange,	
Raspatorien	86-92, 138, 227	ROEDER, Tonsillenschnürer	303	SCHMEDEN.....	169
Raspatorien, Ferrozellgriff	89	ROGER, Septumelevatorium	222	scharfe Nasenzange,	
Raspatorium, FARABEUF	90	Rohr, BRUENINGS.....	354	TAKAHASHI	165
Raspatorium, GUILLEN.....	227	Rohrschaftzange Mikro.....	350, 351	scharfe Nasenzange,	
Raspatorium, JANSEN.....	91	ROLLET, Wundhäkchen	250	WATSON-WILLIAMS.....	166
Raspatorium, JOSEPH.....	88	ROSEN, Lanzettenmesser	121	scharfe Nasenzangen....	165, 169-174
Raspatorium, KOENIG	86	ROSEN, Messer.....	120, 121	scharfe Nasenzangen,	
Raspatorium, LANGENBECK.....	86	ROSEN, Nadel	136	HARTMANN	169
Raspatorium, LEMPert	88	ROSEN, Raspatorium	93	scharfer Löffel, BARTH.....	104
Raspatorium, MILLER	92	ROSEN, Saugrohr	129	scharfer Löffel, DAUBENSPECK.....	258
Raspatorium, MOLT	92	ROSER-KOENIG, Mundsperrer	271	scharfer Löffel, HALLE	104, 258
Raspatorium, ROSEN	93	ROUX-BABY, Wundhaken.....	263	scharfer Löffel, JANSEN.....	103
Raspatorium z. Saugen,		RUBIN, Osteotom.....	234	scharfer Löffel, LEMPert	103
Laryngoskopie	353	RUBIN, Septumquetschzange.....	161	scharfer Löffel, MARTINI	105
Raspatorium, WILLIGER.....	87	Rundmesser, PLESTER.....	122	scharfer Löffel, SHEA	134
Raspatorium, WULLSTEIN.....	92	RUSSEL-DAVIS, Zungenspatel.....	278	scharfer Löffel, SPRATT.....	103
Raspel, AUFRICHT	239	RYDEL-SEIFFERT, Stimmgabel	59	scharfer Löffel, VOLKMANN.....	104
Raspel, COTTLE-MALTZ	239	S		scharfer Löffel, WILLIGER.....	105
Raspel, DINGMAN	244	Säge, JOSEPH.....	244, 245	SCHEINMANN, Aufsatz.....	354
Raspel, FOMON.....	240, 241	Säge, LINDEMANN.....	245	Scherchen Mikro, WULLSTEIN	83
Raspel, GALLAHER	243	SANVENERO, feine Schere.....	190	Schere, BABY-METZENBAUM	188
Raspel, GLABELLA	238	Sattelhäkchen, COTTLE.....	252	Schere, BELLUCCI.....	80
Raspel, JOSEPH	238	Saugadapter, HOUSE	129	Schere, BEUSE	201
Raspel, JOSEPH (LEWIS)	239	Saugball, BRUENINGS	55	Schere, BOETTCHER	296
Raspel, LEWIS-JOSEPH.....	239	Sauggriff, WULLSTEIN.....	127, 129	Schere, BONN	192
Raspel, LEWIS-JOSEPH.....	239	Saugkanüle Mikro.....	125, 127	Schere, CAPLAN.....	206
Raspel, MALTZ.....	238	Saugkoagulator,		Schere, chirurgisch,	
Raspel, MALTZ (COTTLE)	239	Non-Stick, monopolar.....	43	STANDARD	117
Raspel, MASING	242	Saugpinzette, bipolar.....	42	Schere, CONVERSE/	
Raspel, PARKES	238	Saugraspatorium, GUILLEN.....	227	WILMER/WALTER.....	194
Raspel, PEET	238	Saugraspatorium,		Schere, COTTLE	194, 198
Raspel, WIENER.....	238	Laryngoskopie	353	Schere, COTTLE-MASING.....	198
Rauchabsaugrohr	338	Saugrohr.....	126, 348	Schere, DEAN	296
REDA, Mikro Schere	203	Saugrohr, BABY-YANKAUER	284	Schere, FISCH	82
REDA, Nasenspekula.....	144	Saugrohr, BARON	128	Schere, FOMON.....	198
REDA, Sichelmesser.....	217	Saugrohr, FERGUSON	213	Schere, GOOD	296
REDA, Stimmgabel.....	58	Saugrohr,		Schere, GORNEY.....	116, 200
REDA, Watteträger.....	64	FRAZIER/FERGUSON	125, 213	Schere, GORNEY-FREEMAN	200
				Schere, GRADLE	195

Schere, GRAEFE	194	Schnürer, BRUENINGS.....	301	Septummeißel, COTTLE	231
Schere, GREENBERG-PAR	202	Schnürer, EVES.....	301	Septummeißel, FOMON	232
Schere, HEYMANN	198	Schnürer, KRAUSE	162	Septummeißel,	
Schere, IRIS	117, 192	Schnürer, KRAUSE-VOSS	162	FREER	100, 230, 236
Schere, JOSEPH.....	116, 190	Schnürer, ROEDER.....	303	Septummeißel, HAJEK.....	236
Schere, KAYE.....	201, 202	Schnürer, VOSS-KRAUSE	162	Septummeißel, KILLIAN-CLAUS..	236
Schere, KELLY	191	Schnürer, WILDE.....	163	Septummeißel, SHEEHAN	232
Schere, KILLIAN.....	343	SCHOENBORN,		Septummeißel, SILVER.....	233
Schere, KILNER (RAGNELL).....	191	Schilddrüsenhaken	317	Septummeißel, WEST	236
Schere, KNAPP	193	Schölly-Volpi-RFO, Adapter.....	20	Septummesser, COTTLE	217
Schere, LITTAUER	199	SCHUHKNECHT, Biegegerät.....	85	Septummesser, FREER	216
Schere, LITTLER.....	194	SCHUHKNECHT,		Septumosteotom, COTTLE	231
Schere, MASING-COTTLE.....	198	Drahtbiegezügchen	81	Septumosteotom, FOMON.....	232
Schere, METZENBAUM.....	115, 188, 189, 297	SCHUKNECHT, Messer	122	Septumosteotom,	
Schere, O'BRIEN.....	199	SCHUKNECHT, Sichelmesser	122	SHEEHAN	101, 232
Schere, Ophthalmologie.....	195	SCHUMACHER, Aufsatz	354	Septumquetschzange, RUBIN.....	161
Schere, PECK-JOSEPH.....	201	Schwungmesser, BALLENGER.....	218	Septumrichtzange, ASCH.....	160
Schere, PERWITZSCHKY.....	298	SEBILEAU, Elevatorium	86	Septumrichtzange, WALSHAM	160
Schere, PRINCE.....	296	SEIFERT, Aufsatz.....	354	Septumzange, BRUENINGS	158
Schere, REDA	203	SEIFFERT-RYDEL, Stimmgabel	59	Septumzange, CRAIG	158
Schere, REYNOLDS		SEMKEN, anatomische Pinzette	95	Septumzange, HEYMANN	157
(JAMESON).....	191	SEMKEN,		Septumzange,	
Schere, SANVENERO.....	190	chirurgische Pinzette	95, 151	JANSEN-MIDDLETON	159
Schere, SHEA.....	80	Septumelevatorium,		Septumzange, KNIGHT.....	157
Schere, SPENCER.....	199	BALLENGER	225	Septumzange,	
Schere, STEVENS	196	Septumelevatorium,		MIDDLETON-JANSEN	159
Schere, STRABISMUS.....	116, 196	BALLENGER-HAJEK	225	Set, Laryngoskope	
Schere, Tumor	207	Septumelevatorium,		322, 325, 327, 329
Schere, UNIVERSAL.....	118, 299	COTTLE	224, 225	SEWALL, Elevatorium	226
Schere, WAGNER	197	Septumelevatorium,		SEXTON, Ohrmesser	71
Schere, WILMER/ WALTER/CONVERSE	194	COTTLE-JOSEPH.....	224	SHAMBAUGH, Häkchen	135
Schere Mikro	119, 203-205	Septumelevatorium, FREER ..	91, 223	SHAPLEIGH, Ohrschlinge.....	67
Schere, Nase.....	187	Septumelevatorium,		SHEA, Mikro Ohrschere	80
Schere, Ohr	80, 82, 83, 131	GOLDMANN.....	226	SHEA, scharfer Löffel	134
Schere, TITAN	203-205	Septumelevatorium,		SHEEHAN, Septumosteotom	
Schilddüsenhaken,		HAJEK-BALLENGER	225	101, 232
SCHOENBORN.....	317	Septumelevatorium, HALLE	222	Sichelmesser.....	121, 122
SCHINK, Dermatome	220	Septumelevatorium, HOWARTH ..	224	Sichelmesser Mikro,	
Schlinge, BILLEAU	65	Septumelevatorium,		Laryngoskopie	352
Schlinge, Elektrode Mini	34, 35	JOSEPH-COTTLE.....	224	Sichelmesser, REDA	217
Schlinge, LANGENBECK	65	Septumelevatorium,		Sichelmesser, SCHUKNECHT	122
Schlinge, SHAPLEIGH	67	KILLIAN	223, 225	Sichelmesser, WULLSTEIN.....	122
Schlinge, WEBER-LOCH	67	Septumelevatorium,		Siebbeinzange, LUC.....	157
Schlingen, Polypenschnürer.....	72	McKENTY.....	92, 222, 224	Siebbeinzange, TAKAHASHI.....	165
SCHMEDEN,		Septumelevatorium,		Siebbeinzange,	
scharfe Nasenzange.....	169	PENNINGTON.....	224	WEIL-BLAKESLEY.....	164
SCHNIDT (BOETTCHER),		Septumelevatorium, PIERCE	223	Siebbeinzangen,	
Tonsillenklemme	281	Septumelevatorium, ROGER	222	WATSON-WILLIAMS.....	166
SCHNIDT, Tonsillenklemme	281	Septumelevatorium, SINUS.....	223	SIEGLE, Ohrspekula	56
Schnürdraht.....	163	Septumkanüle.....	210, 306, 344	Siilkonschlauch f. MclVOR	
		Septummeißel, CINELLI.....	232	Mundsperrer	277
		Septummeißel, CLAUS-KILLIAN..	236	SILVER, Dermatome	221

- SILVER, Septummeißel233
Sinoskopietrokar215
SINUS, Nasensonde261
SINUS, Septumlevatorium223
Sinusdilator, HALLE-RITTER261
Sinuskop15
Sinuskopiezange178, 179
SLUDER-BALLENGER,
Tonsillotom305
SMITH-KERRISON, Stanze181
Sonde, BOWMAN262, 293
Sonde, FRONTAL261
Sonde, KOCHER317
Sonde, RITTER-HALLE261
Sonde, SINUS261
Sonde, STACHE63
Sonde, WILDER261
Spannarm, YASARGIL57
Spannplatte, Dermatome220
Spatel, BRUENINGS268
Spatel, BUCHWALD268
Spatel, DOUGHTY279
Spatel, FRENZEL268
Spatel, KROENIG268
Spatel, Laryngoskop323-331
Spatel, McIVOR277
Spatel, RING272
Spatel, RUSSEL-DAVIS278
Speichelgangschere,
PERWITZSCHKY298
SPENCER, Fadenschere199
Spiegel, CLAR26
Spiegel, MICHEL345
Spiegel, ZIEGLER23
SPRATT, scharfer Löffel103
Spritze, Tonsille210, 306, 344
Spülkanüle, EICKEN (KILLIAN)212
Spülkanüle, KILLIAN212
Spülkanüle, KILLIAN-EICKEN212
St. CLAIR-THOMSON,
Nasenrachenzange310
St. CLAIR-THOMSON,
Ringmesser309
STACHE, Ohrsonde63
STANDARD, Pinzette, chirurgisch95
STANDARD, Schere, chirurgisch117
Stanze, Antrum184, 185
Stanze, CITELLI109
Stanze, DIETER84
Stanze,
FERRIS-SMITH-KERRISON181
Stanze, HAJEK-KOFLER182, 183
Stanze, KERRISON109, 182
Stanze, KOFLER-HAJEK182
Stanze, OSTROEM184
Stanze, SMITH-KERRISON181
Stanze, Zirkular186
STERNBERG, Wangenhalter270
STEVENS, feine Schere196
STEVENS, Supercuttschere196
Stichkoagulationselektrode,
bipolar44
Stimmgabel, HARTMANN58
Stimmgabel, LUCAE59
Stimmgabel, REDA58
Stimmgabel, RYDEL-SEIFFERT59
Stimmgabel, SEIFFERT-RYDEL59
Stimmgabeln58, 59
Stirnlampe26, 27
Stirnlampe, CLAR26
Stirnlampe, LED27
Stirnlampe, XENON27
Stirnleuchte24-27
Stirnspiegel, ZIEGLER23
Stirnstreifen f. ZIEGLER23
Stopfer, LUNIATSCHKE292
Storz-Aesculap-
Kaltlichtkabeladapter20
Stössel98
STRABISMUS,
feine Schere116, 196
STRUEMPEL,
Fremdkörperzängchen75
STRUYCKEN,
scharfe Nasenzange169
Stützstange, Laryngoskop335
Submukosamesser,
FREER-INGALS219
Supercuttschere,
BABY-METZENBAUM188
Supercuttschere, STEVENS196
Supercuttschere, WAGNER197
- T**
TABB, Messer122
TAKAHASHI,
scharfe Nasenzange165
Tamponpinzette, JANSEN150
Tamponpinzette, TROELTSCH149
Tamponstopfer, LUNIATSCHKE292
Tamponzange, LISTER (Sinus)155
Tamponzange, LUBET-BARBON154
Tamponzange, TILLEY74, 155
Tamponzange, WESTMACOTT154
Tele-Laryngoskop17
THILENIUS, Tonsillenzange283
THUDICHUM, Nasenspekula140
TIECK-HALLE, Nasenspekula144
TILLEY, Tamponzange74, 155
TITAN Mikro Nadelhalter123
TITAN Mikro Scheren203-205
TOBOLD, Zungendrucker270
Tonsillendissektor,
ALDERDYCE290
Tonsillendissektor,
CARPENTER291
Tonsillendissektor, HENKE290
Tonsillendissektor, HURD290
Tonsillendissektor,
LOPEZ-REINKE290
Tonsillendraht302, 319
Tonsillenelevatorium, HENKE290
Tonsillenelevatorium,
YANKAUER290
Tonsillenenukleator,
CARPENTER291
Tonsillenklemme,
BOETTCHER (SCHNIDT)281
Tonsillenklemme, MIKULICZ283
Tonsillenklemme, NEGUS281
Tonsillenklemme, SAWTELL281
Tonsillenklemme, SCHNIDT281
Tonsillenklemme, SCHNIDT
(BOETTCHER)281
Tonsillennmesser, ABRAHAM287
Tonsillennmesser, BRUENINGS287
Tonsillennmesser, CANFIELD287
Tonsillennmesser, FISHER286
Tonsillennadel210, 306, 344
Tonsillennadel, CLAUS285
Tonsillennadel, DUPUY-WEISS285
Tonsillennadel, NAGER286
Tonsillenschere, BOETTCHER296
Tonsillenschere, DEAN296
Tonsillenschere, GOOD296
Tonsillenschere, PRINCE296
Tonsillenschnürer, BRUENINGS301
Tonsillenschnürer, EVES301
Tonsillenschnürer, ROEDER303
Tonsillenschnürer, TYDING300
Tonsillenspritze210, 306, 344
Tonsillenzange, ABRAHAM282
Tonsillenzange, BALLENGER281
Tonsillenzange, BLOHMKE281
Tonsillenzange, COLVER281
Tonsillenzange, DENIS-BROWN283

- Tonsillenzange, HARTMANN307
Tonsillenzange, MARSCHIK282
Tonsillenzange, THILENIUS283
Tonsillenzange, TYDING282
Tonsillenzange, WHITE281
Tonsillotom,
BALLENGER-SLUDER305
TOYNBEE, Ohrspekula53
Trachealdilatator,
TROUSSEAU-BABY314
Trachealhaken, BOSE315
Trachealhaken, JACKSON314
Trachealhaken, NEWS315
Trachealkanüle,
CHEVALIER-JACKSON316
Trachealkanüle, LUER316
Trachealkanüle,
WAGENER-MOSHER315
Trachealwundspreizer, BOSE314
Tracheldilatator, LABORDE314
Tracheldilatator, TROUSSEAU314
Trachelhaken, ITERSON315
Transformator26
TROELTSCH,
Nasentamponpinzette149
TROELTSCH-WILDE,
Ohr-Nasen-Pinzette94, 152
Trokar, COAKLEY215
Trokar, LICHTWITZ215
Trokar, Sinoskopie215
Trommelfellnadel, LUCAE70
Trommelfellnadel, POLITZER ..70, 71
TROUSSEAU, Trachealdilatator...314
TROUSSEAU-BABY,
Trachealdilatator314
Tumorschere207
Tupferzange, DUPLAY295
TYDING, Tonsillenschnürer300
TYDING, Tonsillenzange282
TYRELL, Wundhäkchen246
- U**
UCKERMANN, Watteträger64
Uhrmacherpinzetten96
Umstechungsnadel,
Laryngoskopie353
UNIVERSAL,
Draht- u. Blechscherer118, 299
UNIVERSAL, Pulverbläser60
Uvulahaken, LOTHROP288
Uvulahaken, LOVE288
- V**
Ventilball, KABIERSKE60
Verbindungskabel, bipolar39
Verlängerungsrohr,
BRUENINGS354
VIENNA, Nasenspekula143
VOLKMANN, scharfer Löffel104
Volpi-Schölly-RFO, Adapter20
VOLTOLINI, Nasenspekula140
Vomerzange,
CRAIG-DOMINICK158
VOSS-KRAUSE,
Polypenschnürer162
- W**
WAGENER, Wundhäkchen66
WAGENER-MOSHER,
Trachealkanüle315
WAGNER, feine Schere197
WAGNER, Supercutschere197
WALSHAM, Septumrichtzange ...160
WALTER, Flachmeißel235
Wangenhalter270
Wangenhalter,
CAWOOD-MINNESOTA268
Wangenhalter, STERNBERG270
Warmlichtgriff333
WATSON, Dermatome221
WATSON-WILLIAMS,
scharfe Nasenzange166
Watteträger63, 64, 347
Watteträger, FARRELL63
Watteträger, FEIN347
Watteträger, FROHN63
Watteträger, JOBSON-HORNE64
Watteträger, KILLIAN347
Watteträger, REDA64
Watteträger, UCKERMANN64
WEBER-LOCH, Ohrschlinge67
WEBSTER, Nadelhalter209
WEIL-BLAKESLEY,
Nasenzange164, 168
WEITLANER, Wundspreizer111
WEST, Septummeißel236
WESTMACOTT,
Nasentamponzange154
WHITE, Tonsillenzange281
WIEDER, Zungendrucker269
WIEN, Nasenspekula143
WIENER, Antrumraspel238
WILDE (TROELTSCH),
Ohr-Nasen-Pinzette94, 152
WILDE, Polypenschnürer72, 163
WILDER, Nasensonde261
WILLIGER, Raspatorium87
WILLIGER, scharfer Löffel105
WILLIGER, Wundhaken114
Winter+IBE, Adapter20
Wolf-Kaltlichtkabeladapter20
WULLSTEIN,
Mikro Löffelzängchen79
WULLSTEIN,
Mikro Ohrscherchen83
WULLSTEIN,
Mikro Ohrzängchen79
WULLSTEIN, Raspatorium92
WULLSTEIN, Sauggriff127, 129
WULLSTEIN, Saugrohr127
WULLSTEIN, Sichelmesser122
WULLSTEIN, Wundspreizer113
Wundhäkchen, BARSKY248
Wundhäkchen, BERGMANN250
Wundhäkchen, FRAZIER246
Wundhäkchen, FREER254
Wundhäkchen, GILLIES254
Wundhäkchen, GRAEFE246
Wundhäkchen, GUTHRIE246
Wundhäkchen, HUMBY248
Wundhäkchen, JOSEPH247
Wundhäkchen,
KLEINERT-KUTZ247
Wundhäkchen, KNAPP250
Wundhäkchen, LAHEY246
Wundhäkchen, LUCAE66, 250
Wundhäkchen, REDA249
Wundhäkchen, ROLLET250
Wundhäkchen, TYRELL246
Wundhaken,
BRÜNINGS-BRUNK263
Wundhaken, HOFER289
Wundhaken,
KOCHER-LANGENBECK263
Wundhaken, LOTHROP288
Wundhaken, LOVE288
Wundhaken, MASING251
Wundhaken, MIDDELDORPF263
Wundhaken, NAGER289
Wundhaken, ROUX-BABY263
Wundhaken, WILLIGER114
Wundsperrer110-113
Wundsperrer, ADSON112
Wundsperrer, ALM110
Wundsperrer, BOSE314
Wundsperrer, FINSEN110

Wundsperrerr, FISCH.....	112, 265	Zange, CRAIG-DOMINICK.....	158	Zungenspatel, DAVIS-BOYLE.....	273
Wundsperrerr, HOLZHEIMER.....	110	Zange, DENIS-BROWN.....	283	Zungenspatel, DOUGHTY.....	279
Wundsperrerr, JANSEN.....	110	Zange, FRAENKEL.....	342	Zungenspatel, FRENZEL.....	268
Wundsperrerr, MOLLISON.....	112	Zange, HARTMANN.....	154, 169, 307	Zungenspatel, Holz.....	268
Wundsperrerr, PLESTER.....	113, 264	Zange, HEYMANN.....	157	Zungenspatel, KROENIG.....	268
Wundsperrerr, WEITLANER.....	111	Zange, HOUSE-GELFOAM.....	85	Zungenspatel, McIVOR.....	277
Wundsperrerr, WULLSTEIN.....	113	Zange, JACKSON-CHEVALIER.....	356	Zungenspatel, RING.....	272
X		Zange, JANSEN-MIDDLETON.....	159	Zungenspatel, RUSSEI-DAVIS.....	278
Xenon-Stirnlampe.....	27	Zange, JATHO.....	310	Zungenzange, COLLIN.....	270
Y		Zange, JURASZ.....	311, 342	Zungenzange, YOUNG.....	270
YANKAUER, Saugrohr.....	284	Zange, KEYMANN-KNIGHT.....	156	Zystoskop.....	16
YANKAUER,		Zange, KNIGHT.....	157		
Tonsillenelevatorium.....	290	Zange, LAHEY.....	318		
YASARGIL,		Zange, LITTAUER.....	156		
Fixiervorrichtung.....	57, 148	Zange, LUBET-BARBON.....	154		
YASARGIL, flexibler Spannarm.....	57	Zange, LUC.....	157		
YASARGIL, Ohrspekulahalter.....	57	Zange, MARSCHIK.....	282		
YASARGIL, Ohrtrichterhalter.....	57	Zange, McINDOE.....	108, 208		
YOUNG, Zungenzange.....	270	Zange, MIDDLETON-JANSEN.....	159		
Z		Zange, NOYES.....	155		
Zängchen, BUCK.....	73	Zange, Ohr.....	131		
Zängchen, DUCKBILL.....	75	Zange, RUBIN.....	161		
Zängchen, GREVEN.....	81	Zange, Sinuskopie.....	178, 179		
Zängchen, HARTMANN.....	74, 75	Zange, St. CLAIR-THOMSON.....	310		
Zängchen,		Zange, STRUYCKEN.....	169		
HARTMANN-HOFFMANN.....	75, 175	Zange, THILENIUS.....	283		
Zängchen,		Zange, THILDING.....	282		
HARTMANN-WEINGÄRTNER.....	75	Zange, WALSHAM.....	160		
Zängchen,		Zange, WATSON-WILLIAMS.....	166		
HARTMANN-WULLSTEIN.....	75, 175	Zange, WEIL-BLAKESLEY.....	164, 168		
Zängchen, LITTAUER.....	74	Zange, WESTMACOTT.....	154		
Zängchen, McGEE.....	81	Zange, WHITE.....	281		
Zängchen, Mikro.....	75-81	Zange, YOUNG.....	270		
Zängchen, Ohr.....	76, 77	ZAUFAL, Ohrhebel.....	65		
Zängchen, SCHUHKNECHT.....	81	ZAUFAL-JANSEN,			
Zängchen, STRUEMPEL.....	75	Hohlmeißelzange.....	107		
Zängchen, TILLEY.....	74, 155	ZAUFAL-JANSEN, Ohrhebel.....	65		
Zängchen, WULLSTEIN.....	79	ZIEGLER, Stirnspiegel.....	23		
Zange, ABRAHAM.....	282	Zirkularstanze.....	186		
Zange, ASCH.....	160	ZÖLLNER, Saugrohr.....	125		
Zange, BALLENGER.....	281	Zungendrücker, ANDREW.....	269		
Zange, Biopsie.....	15, 167	Zungendrücker, DINGMANN.....	276		
Zange, BLAKESLEY.....	164, 168, 180	Zungendrücker, HARTMANN.....	269		
Zange, BLOHMKE.....	281	Zungendrücker,			
Zange, BRUENINGS.....	158	KILNER-DOUGHTY.....	275		
Zange, CHEVALIER-JACKSON.....	356	Zungendrücker,			
Zange, COLLIN.....	270	MORITZ-SCHMIDT.....	269		
Zange, COLVER.....	281	Zungendrücker, TOBOLD.....	270		
Zange, CRAIG.....	158	Zungendrücker, WIEDER.....	269		
		Zungenspatel.....	268		
		Zungenspatel, BRUENINGS.....	268		
		Zungenspatel, BUCHWALD.....	268		

- A**
- ABRAHAM forceps282
- ABRAHAM knife287
- adaptor for cable20
- adenoid BARNHILL308
- adenoid curette BECKMANN308
- adenoid curette
- St. CLAIR-THOMSON309
- adenotome LAFORCE309
- ADSON dressing forceps97
- ADSON tissue forceps97
- ADSON retractor111
- air bag POLITZER61
- alar retractor CONVERSE252
- alar retractor COTTLE252, 253
- alar retractor
- COTTLE-NEIVERT252
- alar retractor FOMON253
- alar retractor KILNER253
- ALDERDYCE tonsil dissector290
- ALM retractor109
- ANDREW tongue depressor269
- antrum curette COAKLEY256
- antrum curette FAULKNER256
- antrum elevator SEWALL226
- antrum punch184, 185
- antrum curette256, 257
- applicator cotton FARRELL63
- applicator cotton FROHN63
- applicator cotton
- JOBSON-HORNE64
- applicator cotton REDA64
- applicator cotton UCKERMANN64
- ASCH septum straightening
- forceps160
- AUFRICHT nasal rasp239
- AUFRICHT nasal retractor251
- B**
- BALLENGER septum elevator225
- BALLENGER tonsil forceps281
- BALLENGER
- septum swivel knife218
- BANE-HARTMANN
- bone rongeur106
- BARACANI tip354
- BARANY noise apparatus60
- BARBARA needle ROSEN... 135, 136
- BARNHILL adenoid curette308
- BARON suction tube128
- BARRAQUER
- micro needle holder123
- BARSKY retractor248
- BARTH bone curette104
- BECKMANN adenoid curette308
- BELLUCCI micro ear scissors80
- bending device SCHUKNECHT ...85
- BERGMANN retractor250
- BEUSE face lift scissors201
- BEYER bone rongeur107
- BILLEAU ear loop65
- biopsy forceps15
- biopsy punch179
- bipolar suction forceps42
- bipolar forceps36, 37, 38
- bipolar cable39
- bipolar stitch electrode44, 45
- bipolar forceps NON STICK ...40, 41
- blades tongue DOUGHTY279
- blades tongue RUSSEL-DAVIS...278
- blepharoplasty scissors
- GREENBERG-PAR202
- blepharoplasty scissors KAYE202
- BLOHMKE tonsil forceps281
- BLUMENTHAL bone rongeur106
- BOETTCHER tonsil scissors296
- BÖHLER bone rongeur107, 108
- BOIES nasal fracture elevator226
- bone rongeur
- BANE-HARTMANN106
- bone curette BARTH104
- bone rongeur BEYER107
- bone rongeur BLUMENTHAL106
- bone rongeur BÖHLER107, 108
- bone punch CITELLI109
- bone rongeur
- COTTLE-KAZANJIAN108
- bone curette DAUBENSPECK258
- bone punch
- FERRIS-SMITH-KERRISON181
- bone curette HALLE104, 258
- bone rongeur KLEINERT-KUTZ...107
- bone curette LEMPERT103
- bone rongeur LEMPERT107
- bone rongeur LUER106
- bone curette MARTINI105
- bone rongeur MC INDOE108
- bone tamper PASSOW98, 235
- bone curette SPRATT103
- bone curette VOLKMANN104
- bone curette WILLIGER105
- bone rongeur ZAUFAL-JANSEN ..107
- bone curette JANSEN103
- bone cutting forceps
- COTTLE-KAZANJIAN208
- bone cutting forceps MC INDOE ..208
- BONN scissors192
- BOSE tracheal spreader314, 315
- BOUCHERON ear specula53
- BOWMAN lacrimal probe262
- BOWMAN salivary duct probe293
- bronchoscope forceps
- CHEVALIER-JACKSON356
- bronchoscope18
- BRUENINGS tongue depressor ...268
- BRUENINGS
- nasal septum forceps158
- BRUENINGS tonsil knife287
- BRUENINGS tonsil snare301
- BRUENINGS ear specula set55
- BRUENINGS handle354
- BRUENINGS tip354
- BRÜNINGS-BRUNK retractor263
- BRÜNINGS-LUCAS gouge98
- BUCHWALD tongue depressor268
- BUCK ear curette68, 69
- BUCK foreign body lever73
- burr30, 31
- C**
- cable bipolar39
- cable light guide19
- CANFIELD tonsil knife287
- cannula EICKEN212
- cannula KILLIAN212
- cannula laryngeal210, 306, 344
- cannula septum210, 306, 344
- cannula tracheal
- CHEVALIER-JACKSON316
- cannula tracheal LUER316
- CAPLAN nasal scissors206
- CARPENTER tonsil enucleator291
- carrier cotton FEIN347
- carrier cotton KILLIAN347
- carrier cotton347
- carrier fibreglass light337, 338
- cartilage crusher COTTLE237
- cartilage file DINGMANN130
- cartilage knife MASING219
- CASTROVIEJO
- micro needle holder124
- catheter ear HARTMANN70
- CAWOOD-MINNESOTA
- tongue depressor268
- cheek retractor STERNBERG270
- cheek retractor270

chest support LEWY.....	336	COTTLE-JOSEPH		DENIS BROWNE tonsil forceps ...	283
chest support NEGUS.....	280	septum elevator.....	224	depressor tongue ANDREW.....	269
CHEVALIER-JACKSON		COTTLE-KAZANJIAN		depressor tongue BRUENINGS ...	268
tracheal cannula.....	316	bone cutting forceps.....	208	depressor tongue BUCHWALD	268
CHEVALIER-JACKSON		COTTLE-KAZANJIAN		depressor tongue	
bronchoscope forceps.....	356	bone rongeur.....	108	CAWOOD-MINNESOTA.....	268
chisel FREER.....	100	COTTLE-MASING		depressor tongue	
chisel PARTSCH.....	99	nasal scissors.....	198	DAVIS-BOYLE.....	273
chisel WALTER.....	235	COTTLE-NEIVERT		depressor tongue FRENZEL.....	268
chisel.....	98	alar retractor.....	252	depressor tongue HARTMANN.....	269
chisel rhinoplasty CINELLI.....	232	cotton applicator FARRELL.....	63	depressor tongue KROENIG.....	268
chisel rhinoplasty COTTLE.....	231	cotton carrier FEIN.....	347	depressor tongue	
chisel rhinoplasty FOMON.....	232	cotton applicator FROHN.....	63	MORITZ-SCHMIDT.....	269
chisel rhinoplasty		cotton applicator		depressor tongue RING.....	272
NEIVERT-ANDERSON.....	233	JOBSON-HORNE.....	64	depressor tongue TOBOLD.....	270
chisel rhinoplasty SHEEHAN.....	232	cotton carrier KILLIAN.....	347	depressor tongue WIEDER.....	269
chisel rhinoplasty SILVER.....	233	cotton applicator REDA.....	64	depressor tongue.....	268
chisel septum FREER.....	230	cotton applicator UCKERMANN.....	64	DERF needle holder.....	209
choana hook LANGE.....	255	cotton carrier.....	347	DERLACKI tissue forceps.....	97
CINELLI rhinoplasty chisel.....	232	CRAIG nasal septum forceps.....	158	dermatome HUMBY.....	221
circular punch.....	186	CRAIG-DOMNICK		dermatome SCHINK.....	220
CITELLI bone punch.....	109	nasal septum forceps.....	158	dermatome SILVER.....	221
clamp muscular MASTIN.....	318	CRILE-WOOD needle holder.....	209	dermatome WATSON.....	221
CLAUS tonsil needle.....	285	crusher cartilage COTTLE.....	237	diagnostic set.....	48, 49, 50, 51, 52
coagulation suction tube.....	211	curette adenoid BARNHILL.....	308	DIETER malleus punch.....	84
coagulator monopolar suction.....	43	curette adenoid BECKMANN.....	308	dilator lachrimal WILDER.....	261
COAKLEY antrum curette.....	256	curette adenoid		dilator sinus RITTER-HALLE.....	261
COAKLEY trocar.....	215	St. CLAIR-THOMSON.....	309	dilator tracheal LABORDE.....	314
COLLIN tongue forceps.....	270	curette antrum COAKLEY.....	256	dilator tracheal TROUSSEAU.....	314
columella forceps COTTLE.....	153	curette antrum FAULKNER.....	256	dilator tracheal	
COLVER tonsil forceps.....	281	curette antrum.....	256, 257	TROUSSEAU-BABY.....	314
CONVERSE nasal knife.....	217	curette bone BARTH.....	104	DINGMANN cartilage file.....	130
CONVERSE alar retractor.....	252	curette bone DAUBENSPECK.....	258	DINGMANN mouth gag.....	276
CONVERSE scissors.....	194	curette bone HALLE.....	104, 258	DINGMANN nasal rasp.....	244
CORDES tip.....	354	curette bone LEMPert.....	103	dissecting scissors GORNEY.....	116
COTTLE rhinoplasty chisel.....	231	curette bone MARTINI.....	105	dissecting scissors JAMESON.....	191
COTTLE cartilage crusher.....	237	curette bone SPRATT.....	103	dissecting scissors	
COTTLE septum elevator.....	224, 225	curette bone VOLKMANN.....	104	JOSEPH.....	116, 190
COTTLE columella forceps.....	153	curette bone WILLIGER.....	105	dissecting scissors KELLY.....	191
COTTLE ear forceps.....	94	curette bone JANSEN.....	103	dissecting scissors KILNER.....	191
COTTLE nasal forceps.....	152	curette ear BUCK.....	68, 69	dissecting scissors	
COTTLE nasal knife.....	217	curette micro HOUSE.....	133	METZENBAUM	115, 188, 189, 297
COTTLE nasal rasp.....	239			dissecting scissors	
COTTLE alar retractor.....	252, 253	D		METZENBAUM FINO.....	115, 189
COTTLE finger ring retractor.....	255	DAUBENSPECK bone curette.....	258	dissecting scissors RAGNELL.....	191
COTTLE nasal retractor.....	251	DAVIS-BOYLE		dissecting scissors REYNOLDS...	191
COTTLE nasal scissors.....	198	tongue depressor.....	273	dissecting scissors	
COTTLE nasal specula.....	146, 147	DAVIS-BOYLE mouth gag.....	274	SANVENERO.....	190
COTTLE mallet.....	102, 260	DAVIS-MEYER mouth gag.....	277	dissecting scissors	
COTTLE osteotome.....	100	DAY ear hook.....	66	STRABISMUS.....	116, 196
COTTLE retractor.....	254	DEAN tonsil scissors.....	296	dissector FISCH.....	93
COTTLE scissors.....	194	DENHART mouth gag.....	271	dissector thyroid KOCHER.....	317

- dissector tonsil ALDERDYCE290
 dissector tonsil HURD290
 dissector tonsil LOPEZ-REINKE ..290
 DOUGHTY tongue blades279
 DOYEN-JANSEN mouth gag271
 dressing forceps ADSON.....97
 dressing forceps DUPLAY295
 dressing forceps GRAEFE95
 dressing forceps POTTS-SMITH..294
 dressing forceps SEMKEN.....95
 dressing forceps STANDARD.....95
 dressing forceps295
 DUCKBILL micro ear forceps75
 DUPLAY dressing forceps295
 DUPUY-WEISS tonsil needle285
- E**
- ear specula BOUCHERON.....53
 ear curette BUCK68, 69
 ear forceps COTTLE94
 ear hook DAY66
 ear specula GRUBER.....53
 ear specula HARTMANN.....53
 ear catheter HARTMANN70
 ear forceps HARTMANN74
 ear forceps LITTAUER74
 ear hook LUCAE.....66
 ear forceps LUCAE.....94
 ear syringe REINER61
 ear loop SHAPLEIGH67
 ear probe STACKE63
 ear hook WAGENER66
 ear forceps WILDE
 (TROELTSCH).....94
 ear loop ZAUFAL65
 ear elevator ZAUFAL-JANSEN.....65
 ear specula55, 56
 ear syringe62
 ear loop BILLEAU.....65
 ear specula FARRIOR.....54
 ear spoon GROSS.....65
 ear loop LANGENBECK.....65
 ear specula POLITZER53
 ear forceps TILLEY.....74
 ear specula TOYNBEE.....53
 ear loop WEBER-LOCH.....67
 ear hook65, 66
 ear polypus forceps
 HARTMANN175
 ear polypus forceps
 HARTMANN-HOFFMANN.....175
 ear polypus forceps
- HARTMANN-WULLSTEIN175
 ear polypus snare KRAUSE72
 ear polypus snare WILDE.....72
 ear specula holder YASARGIL57
 ear specula set BRUENINGS.....55
 ear specula set SIEGLE56
 EICKEN cannula212
 electrode bipolar stitch.....44, 45
 electrodes34, 35
 elevator FREER.....91
 elevator LEMPert.....88, 91
 elevator McKENTY.....92
 elevator QUERVAIN86
 elevator SEBILEAU86
 elevator138
 elevator antrum SEWALL.....226
 elevator ear ZAUFAL-JANSEN.....65
 elevator nasal FRONTAL.....261
 elevator nasal SINUS261
 elevator nasal fracture BOIES226
 elevator septum BALLENGER225
 elevator septum COTTLE.....224, 225
 elevator septum
 COTTLE-JOSEPH.....224
 elevator septum FREER.....223
 elevator septum
 HAJEK-BALLENGER225
 elevator septum HALLE.....222
 elevator septum HOWARTH.....224
 elevator septum JOSEPH.....222
 elevator septum KILLIAN.....223, 225
 elevator septum MASING.....222
 elevator septum McKENTY .222, 224
 elevator septum PENNINGTON...224
 elevator septum PIERCE.....223
 elevator septum ROGER.....222
 elevator septum SINUS223
 elevator septum fracture
 GOLDMANN.....226
 elevator tonsil HENKE290
 elevator tonsil YANKAUER290
 elevator laryngeal suction352
 endoscope18
 enucleator tonsil CARPENTER291
 epiglottis retractor REICHERT.....343
 ethmoid forceps TAKAHASHI.....165
 ethmoid forceps
 WATSON-WILLIAMS.....166
 ethmoid forceps
 WEIL-BLAKESLEY164
 EVES tonsil snare.....301
- F**
- face lift scissors BEUSE201
 face lift scissors GORNEY.....200
 face lift scissors
 GORNEY-FREEMAN200
 face lift scissors KAYE201
 face lift scissors
 PECK-JOSEPH201
 FARABEUf raspatory90
 FARRELL cotton applicator63
 FARRIOR ear specula.....54
 FAULKNER antrum curette256
 FEIN cotton carrier347
 FERGUSSON suction tube213
 FERRIS-SMITH-KERRISON
 bone punch.....181
 fibreglass light carrier337, 338
 fibreglass laryngoscope339
 file cartilage DINGMANN.....130
 finger ring retractor COTTLE255
 FINSen retractor109
 FISCH micro ear scissors.....82
 FISCH dissector93
 FISCH retractor111, 265
 FISHER tonsil knife286
 FOMON rhinoplasty chisel.....232
 FOMON nasal rasp.....240, 241
 FOMON alar retractor.....253
 FOMON nasal scissors.....198
 forceps biopsy15
 forceps bipolar36, 37, 38
 forceps bipolar NON STICK40, 41
 forceps bone cutting
 COTTLE-KAZANJIAN208
 forceps bone cutting MC INDOE ..208
 forceps bronchoscope
 CHEVALIER-JACKSON356
 forceps columella COTTLE153
 forceps dressing ADSON.....97
 forceps dressing DUPLAY295
 forceps dressing GRAEFE95
 forceps dressing POTTS-SMITH..294
 forceps dressing SEMKEN.....95
 forceps dressing STANDARD.....95
 forceps dressing295
 forceps ear COTTLE94
 forceps ear HARTMANN74
 forceps ear LITTAUER74
 forceps ear LUCAE.....94
 forceps ear WILDE
 (TROELTSCH).....94
 forceps ear TILLEY.....74

forceps ear polypus	(Sinus)	155	forceps tonsil WHITE	281
HARTMANN	forceps nasal dressing		forceps tonsil abscess	
175	LUBET-BARBON	154	THILENIUS	283
forceps ear polypus	forceps nasal dressing NOYES	155	forceps micro laryngeal	350, 351
HARTMANN-HOFFMANN	forceps nasal dressing TILLEY	155	forceps bipolar suction	42
175	forceps nasal dressing		foreign body lever BUCK	73
HARTMANN-WULLSTEIN	WESTMACOTT	154	foreign body lever QUIRE	73
175	forceps nasal polypus		fork tuning HARTMANN	58
forceps ethmoid	HEYMANN-KNIGHT	156	fork tuning LUCAE	59
WATSON-WILLIAMS	forceps nasal polypus		fork tuning RYDEL-SEIFFERT	59
166	LITTAUER	156	fork tuning	58, 59
forceps ethmoid	forceps nasal septum		FRAENKEL	
WEIL-BLAKESLEY	BRUENINGS	158	laryngeal polypus forceps	342
164	forceps nasal septum CRAIG	158	FRAENKEL tip	354
forceps jeweler	forceps nasal septum		FRAZER retractor	246
96	CRAIG-DOMNICK	158	FRAZIER/FERGUSSON	
forceps laryngeal JACKSON	forceps nasal septum		suction tube	125, 213
343	HEYMANN	157	FREER septum chisel	230
forceps laryngeal polypus	forceps nasal septum KNIGHT	157	FREER septum elevator	223
FRAENKEL	forceps nasal septum LUC	157	FREER nasal knife	216
342	forceps nasal septum		FREER chisel	100
forceps laryngeal polypus	MIDDLETON-JANSEN	159	FREER elevator	91
JURASZ	forceps naso pharyngeal		FREER gouge	236
342	JATHO	310	FREER retractor	254
forceps maxillary sinus	forceps naso pharyngeal		FREER-INGALS mucosa knife	219
176, 177	JURASZ	311	FRENZEL nystagmus spectacle	22
forceps micro ear DUCKBILL	forceps naso pharyngeal		FRENZEL tongue depressor	268
75	St. CLAIR-THOMSON	310	FROHN cotton applicator	63
forceps micro ear HARTMANN	forceps pressure		FRONTAL nasal elevator	261
75	HOUSE-GELFOAM	85		
forceps micro ear	forceps seizing LAHEY	318	G	
HARTMANN-HOFFMANN	forceps septum straightening		gag mouth DAVIS-BOYLE	274
75	ASCH	160	gag mouth DAVIS-MEYER	277
forceps micro ear	forceps septum straightening		gag mouth DENHART	271
HARTMANN-WEINGÄRTNER	WALSHAM	160	gag mouth DINGMANN	276
75	forceps tissue ADSON	97	gag mouth DOYEN-JANSEN	271
forceps micro ear	forceps tissue DERLACKI	97	gag mouth HEISTER	271
HARTMANN-WULLSTEIN	forceps tissue POTTS-SMITH	294	gag mouth JENNINGS	271
75	forceps tissue SEMKEN	95	gag mouth KILNER-DOUGHTY	275
forceps micro ear ...75, 76, 77, 78, 79	forceps tongue YOUNG	270	gag mouth MAUNDER	280
forceps morselizer RUBIN	forceps tongue COLLIN	270	gag mouth McIVOR	277
161	forceps tonsil ABRAHAM	282	gag mouth MOLT	271
forceps nasal COTTLE	forceps tonsil BALLENGER	281	gag mouth ROSER-KOENIG	271
152	forceps tonsil BLOHMKE	281	GALLAHER nasal rasp	243
forceps nasal GILLIES	forceps tonsil COLVER	281	gauze packer LUNIATSCHEK	292
151	forceps tonsil DENIS BROWNE	283	GERZOG mallet	259
forceps nasal GRAEFE	forceps tonsil MARSCHIK	282	GILLIES nasal forceps	151
151	forceps tonsil MIKULICZ	283	GILLIES retractor	254
forceps nasal JANSEN	forceps tonsil NEGUS	281	GLABELLA nasal rasp	238
150	forceps tonsil NEGUS	281	GOLDMANN	
forceps nasal	forceps tonsil SAWTELL	281	septum fracture elevator	226
JANSEN-GRUENWALD	forceps tonsil SCHNIDT	281	GOOD tonsil scissors	296
150	forceps tonsil TYDING	282		
forceps nasal LUCAE				
152				
forceps nasal McINDOE				
151				
forceps nasal TROELTSCH				
149				
forceps nasal WILDE				
(TROELTSCH)				
152				
forceps nasal				
167, 180				
forceps nasal cutting				
HARTMANN				
169				
forceps nasal cutting				
SCHMEDEN				
169				
forceps nasal cutting				
STRUYCKEN				
169				
forceps nasal cutting				
WEIL-BLAKESLEY				
168				
forceps nasal cutting				
170-174, 178				
forceps nasal dressing				
HARTMANN				
154				
forceps nasal dressing LISTER				

- GORNEY dissecting scissors 116
 GORNEY face lift scissors.....200
 GORNEY-FREEMAN
 face lift scissors.....200
 gouge BRÜNINGS-LUCAS98
 gouge FREER236
 gouge LEXER MINI100
 gouge PARTSCH.....99
 gouge WEST236
 gouge98
 gouge rhinoplasty HAJEK.....236
 gouge rhinoplasty
 KILLIAN-CLAUS.....236
 GRADLE scissors195
 GRAEFE dressing forceps95
 GRAEFE nasal forceps151
 GRAEFE retractor246
 GRAEFE scissors194
 GREENBERG-PAR
 blepharoplasty scissors202
 GREVEN micro ear scissors81
 GROSS ear spoon.....65
 GRUBER ear specula.....53
 GUILÉN raspatory suction.....227
 GUTHRIE retractor246
- H**
 HAJEK rhinoplasty gouge.....236
 HAJEK mallet102
 HAJEK-BALLENGER
 septum elevator225
 HAJEK-KOFLER punch182, 183
 HALLE bone curette104, 258
 HALLE septum elevator.....222
 HALSEY needle holder209
 handle BRUENINGS354
 handle HUBER354
 handle laryngeal346
 handle laryngoscope332, 333
 handle suction WULLSTEIN.....129
 HARTMANN ear catheter70
 HARTMANN tongue depressor269
 HARTMANN ear forceps74
 HARTMANN
 ear polypus forceps175
 HARTMANN micro ear forceps75
 HARTMANN
 nasal cutting forceps.....169
 HARTMANN
 nasal dressing forceps.....154
 HARTMANN tuning fork58
 HARTMANN tonsil punch.....307
- HARTMANN ear specula.....53
 HARTMANN nasal specula142
 HARTMANN-HALLE
 nasal specula.....141
 HARTMANN-HOFFMANN
 ear polypus forceps175
 HARTMANN-HOFFMANN
 micro ear forceps.....75
 HARTMANN-WEINGÄRTNER
 micro ear forceps.....75
 HARTMANN-WULLSTEIN
 ear polypus forceps175
 HARTMANN-WULLSTEIN
 micro ear forceps.....75
 head mirror ZIEGLER.....23
 head light24, 25, 26, 27
 HEISTER mouth gag.....271
 HENKE tonsil elevator290
 HEYMANN
 nasal septum forceps157
 HEYMANN nasal scissors.....198
 HEYMANN-KNIGHT
 nasal polypus forceps.....156
 HOFER palate retractor.....289
 HOLZHEIMER retractor109
 hook PLESTER137
 hook choana LANGE.....255
 hook ear DAY66
 hook ear LUCAE.....66
 hook ear WAGENER66
 hook ear65, 66
 hook laryngeal352, 353
 hook tracheal ITERSON.....315
 hook tracheal JACKSON.....314
 hook tracheal NEWS315
 hooklet McGEE.....136
 HOUSE micro curette133
 HOUSE measuring rod.....132
 HOUSE suction tube126, 214
 HOUSE-GELFOAM
 pressure forceps.....85
 HOWARTH septum elevator.....224
 HUBER handle354
 HUMBY dermatome221
 HUMBY retractor248
 HURD tonsil dissector290
- I**
 injection needle349
 instrument handle laryngeal353
 IRIS operating scissors.....117, 192
 ITERSON tracheal hook.....315
- J**
 JACKSON laryngeal forceps343
 JACKSON tracheal hook.....314
 JAMESON dissecting scissors191
 JANSEN bone curette103
 JANSEN nasal forceps150
 JANSEN raspatory91
 JANSEN retractor109
 JANSEN-GRUENWALD
 nasal forceps150
 JATHO naso pharyngeal forceps..310
 JENNINGS mouth gag271
 jeweler forceps96
 JOBSON-HORNE cotton
 applicator.....64
 JOSEPH septum elevator.....222
 JOSEPH nasal knife.....216, 217
 JOSEPH nasal rasp.....238, 239
 JOSEPH nasal saw244, 245
 JOSEPH
 dissecting scissors.....116, 190
 JOSEPH raspatory88
 JOSEPH retractor247
 JURASZ
 laryngeal polypus forceps.....342
 JURASZ
 naso pharyngeal forceps311
- K**
 KABIERSKE powder blower60
 KAYE blepharoplasty scissors.....202
 KAYE face lift scissors.....201
 KELLY dissecting scissors.....191
 KERRISON punch109, 182
 KILLIAN cotton carrier347
 KILLIAN septum elevator.....223, 225
 KILLIAN laryngeal scissors.....343
 KILLIAN nasal specula144, 145
 KILLIAN cannula212
 KILLIAN-CLAUS
 rhinoplasty gouge236
 KILNER alar retractor253
 KILNER dissecting scissors.....191
 KILNER-DOUGHTY mouth gag ...275
 KLEINERT-KUTZ bone rongeur ...107
 KLEINERT-KUTZ retractor247
 KNAPP retractor250
 KNAPP scissors193
 knife PLESTER122
 knife ROSEN.....120, 121
 knife SCHUKNECHT122
 knife TABB.....122

- knife WULLSTEIN122
 knife121
 knife cartilage MASING219
 knife laryngeal352, 353
 knife mucosa FREER-INGALS.....219
 knife nasal CONVERSE217
 knife nasal COTTLE217
 knife nasal FREER216
 knife nasal JOSEPH.....216, 217
 knife septum swivel
 BALLENGER218
 knife sickle REDA217
 knife tonsil ABRAHAM287
 knife tonsil BRUENINGS287
 knife tonsil CANFIELD.....287
 knife tonsil FISHER286
 knife tympanum LUCAE70
 knife tympanum POLITZER.....70, 71
 knife tympanum SEXTON71
 KNIGHT nasal septum forceps.....157
 knot tier NEGUS304
 knot laryngeal tier352
 KOCHER thyroid dissector317
 KOCHER-LANGENBECK
 retractor263
 KÖNIG raspatory86
 KRAUSE ear polypus snare72
 KRAUSE nasal polypus snare.....162
 KRAUSE tip354
 KRAUSE-VOSS
 nasal polypus snare.....162
 KROENIG tongue depressor.....268
- L**
 LABORDE tracheal dilator.....314
 lachrymal probe BOWMAN262
 lachrymal dilator WILDER261
 LAFORCE adenotome309
 LAHEY seizing forceps.....318
 LAHEY retractor246
 LANGE choana hook.....255
 LANGE tip354
 LANGENBECK ear loop.....65
 LANGENBECK raspatory86
 larangeal micro scissors.....351
 laryngeal suction elevator.....352
 laryngeal forceps JACKSON343
 laryngeal scissors KILLIAN.....343
 laryngeal mirror MICHEL.....345
 laryngeal knot tier352
 laryngeal cannula210, 306, 344
 laryngeal mirror346
- laryngeal handle346
 laryngeal knife352, 353
 laryngeal hook352, 353
 laryngeal needle352
 laryngeal instrument handle353
 laryngeal micro forceps350, 351
 laryngeal polypus snare.....319
 laryngeal needle holder349
 laryngeal polypus forceps
 FRAENKEL.....342
 laryngeal polypus forceps
 JURASZ.....342
 laryngoscope McCOY.....324, 331
 laryngoscope McINTOSH
322, 323, 327, 328
 laryngoscope MILLER
325, 326, 329, 330
 laryngoscope17
 laryngoscope handle332, 333
 laryngoscope spare bulb332, 333
 laryngoscope fibreglass339
 laryngoscope operation
334, 335, 340, 341
 LEMPert bone curette.....103
 LEMPert bone rongeur107
 LEMPert elevator88, 91
 LEMPert raspatory88
 lever foreign body BUCK.....73
 lever foreign body QUIRE.....73
 LEWIS nasal rasp.....239
 LEWY chest support336
 LEXER osteotome228
 LEXER MINI gouge100
 LEXER MINI osteotome100
 LEYLA retractor148
 LICHTWITZ trocar215
 light fibreglass carrier337, 338
 light guide cable19
 LINDEMANN nasal saw245
 LISTER (Sinus)
 nasal dressing forceps.....155
 LITTAUER ear forceps74
 LITTAUER
 nasal polypus forceps.....156
 LITTAUER stitch scissors.....199
 LITTLER scissors194
 loop ear SHAPLEIGH.....67
 loop ear ZAUFAL.....65
 loop ear BILLEAU.....65
 loop ear LANGENBECK.....65
 loop ear WEBER-LOCH.....67
 LOPEZ-REINKE tonsil dissector ..290
- LOTHROP uvula retractor288
 LOVE uvula retractor.....288
 LUBET-BARBON
 nasal dressing forceps.....154
 LUC nasal septum forceps157
 LUCAE ear forceps.....94
 LUCAE nasal forceps152
 LUCAE tuning fork.....59
 LUCAE ear hook.....66
 LUCAE tympanum knife70
 LUCAE retractor250
 LUER tracheal cannula.....316
 LUER bone rongeur.....106
 LUNIATSCHEK gauze packer292
- M**
 mallet COTTLE102, 260
 mallet GERZOG259
 mallet HAJEK102
 mallet MEAD.....102, 259
 mallet PARTSCH102, 260
 mallet QUISLING.....260
 mallet102, 259
 mallet plastic260
 malleus punch DIETER84
 MALTZ nasal rasp238, 239
 MARSCHIK tonsil forceps282
 MARTINI bone curette.....105
 MASING septum elevator.....222
 MASING cartilage knife219
 MASING nasal rasp.....242
 MASING nasal retractor251
 MASING-NEIVERT
 nasal retractor.....251
 MASTIN muscular clamp.....318
 MAUNDER mouth gag280
 maxillary sinus forceps176, 177
 MC INDOE
 bone cutting forceps208
 MC INDOE bone rongeur108
 McCOY laryngoscope324, 331
 McGEE hooklet136
 McGHEE micro ear scissors.....81
 McINDOE nasal forceps151
 McIntOSH laryngoscope
322, 323, 327, 328
 McIVOR mouth gag.....277
 McKENTY septum elevator ..222, 224
 McKENTY elevator92
 MEAD mallet102, 259
 measuring rod HOUSE.....132

- METZENBAUM dissecting scissors 115, 188, 189, 297
 METZENBAUM FINO
 dissecting scissors..... 115, 189
 MICHEL laryngeal mirror345
 micro needle holder
 BARRAQUER.....123
 micro needle holder
 CASTROVIEJO124
 micro laryngeal forceps350, 351
 micro curette HOUSE133
 micro larangeal scissors351
 micro scissors 119, 131, 203-205
 micro ear scissors BELLUCCI.....80
 micro ear forceps DUCKBILL75
 micro ear scissors FISCH82
 micro ear scissors GREVEN81
 micro ear forceps HARTMANN75
 micro ear forceps
 HARTMANN-HOFFMANN.....75
 micro ear forceps
 HARTMANN-WEINGÄRTNER75
 micro ear forceps
 HARTMANN-WULLSTEIN75
 micro ear scissors McGHEE.....81
 micro ear scissors
 SCHUKNECHT.....81
 micro ear scissors SHEA.....80
 micro ear scissors WULLSTEIN83
 micro ear forceps ...75, 76, 77, 78, 79
 MIDDELDORPF retractor263
 MIDDLETON-JANSEN
 nasal septum forceps159
 MIKULICZ tonsil forceps.....283
 MILLER laryngoscope
325, 326, 329, 330
 MILLER raspatory92
 MILLER-LAMBOTTE osteotome
99, 229
 mirror head ZIEGLER.....23
 mirror laryngeal MICHEL345
 mirror laryngeal346
 MOLLISON retractor111
 MOLT mouth gag.....271
 MOLT raspatory92
 monopolar suction coagulator43
 MORITZ-SCHMIDT
 tongue depressor.....269
 morselizer forceps RUBIN161
 mouth gag DAVIS-BOYLE.....274
 mouth gag DAVIS-MEYER.....277
 mouth gag DENHART271
 mouth gag DINGMANN.....276
 mouth gag DOYEN-JANSEN271
 mouth gag HEISTER271
 mouth gag JENNINGS271
 mouth gag KILNER-DOUGHTY ...275
 mouth gag MAUNDER280
 mouth gag McIVOR.....277
 mouth gag MOLT271
 mouth gag ROSER-KOENIG.....271
 mucosa knife FREER-INGALS.....219
 muscular clamp MASTIN.....318
- N**
 NAGER tonsil needle.....286
 NAGER palate retractor.....289
 nasal rasp AUFRICHT239
 nasal retractor AUFRICHT.....251
 nasal scissors CAPLAN.....206
 nasal knife CONVERSE217
 nasal specula COTTLE146, 147
 nasal forceps COTTLE152
 nasal scissors COTTLE.....198
 nasal knife COTTLE217
 nasal rasp COTTLE.....239
 nasal retractor COTTLE251
 nasal scissors
 COTTLE-MASING198
 nasal rasp DINGMANN244
 nasal scissors FOMON.....198
 nasal rasp FOMON.....240, 241
 nasal knife FREER216
 nasal elevator FRONTAL.....261
 nasal rasp GALLAHER.....243
 nasal forceps GILLIES.....151
 nasal rasp GLABELLA.....238
 nasal forceps GRAEFE151
 nasal specula HARTMANN142
 nasal specula
 HARTMANN-HALLE.....141
 nasal scissors HEYMANN.....198
 nasal forceps JANSEN150
 nasal forceps
 JANSEN-GRUENWALD150
 nasal knife JOSEPH216, 217
 nasal rasp JOSEPH.....238, 239
 nasal saw JOSEPH244, 245
 nasal specula KILLIAN144, 145
 nasal rasp LEWIS.....239
 nasal saw LINDEMANN245
 nasal forceps LUCAE152
 nasal rasp MALTZ238, 239
 nasal rasp MASING.....242
 nasal retractor MASING251
 nasal retractor
 MASING-NEIVERT.....251
 nasal forceps McINDOE151
 nasal rasp PARKES.....238
 nasal rasp PEET.....238
 nasal specula REDA.....144
 nasal elevator SINUS261
 nasal specula THUDICHUM.....140
 nasal specula TIECK-HALLE144
 nasal forceps TROELTSCH.....149
 nasal specula VOLTOLINI140
 nasal specula WIEN143
 nasal rasp WIENER.....238
 nasal forceps WILDE
 (TROELTSCH).....152
 nasal forceps167, 180
 nasal scissors187
 nasal cutting forceps
 HARTMANN169
 nasal cutting forceps
 SCHMEDEN169
 nasal cutting forceps
 STRUYCKEN169
 nasal cutting forceps
 WEIL-BLAKESLEY168
 nasal cutting forceps170-174, 178
 nasal dressing forceps
 HARTMANN154
 nasal dressing forceps
 LISTER (Sinus).....155
 nasal dressing forceps
 LUBET-BARBON.....154
 nasal dressing forceps NOYES...155
 nasal dressing forceps TILLEY.....155
 nasal dressing forceps
 WESTMACOTT154
 nasal fracture elevator BOIES.....226
 nasal polypus forceps
 HEYMANN-KNIGHT156
 nasal polypus snare KRAUSE.....162
 nasal polypus snare
 KRAUSE-VOSS.....162
 nasal polypus forceps
 LITTAUER156
 nasal polypus snare WILDE163
 nasal septum forceps
 BRUENINGS158
 nasal septum forceps CRAIG158
 nasal septum forceps
 CRAIG-DOMNICK158
 nasal septum forceps HEYMANN ..157

- nasal septum forceps KNIGHT.....157
 nasal septum forceps LUC.....157
 nasal septum forceps
 MIDDLETON-JANSEN.....159
 naso pharyngeal forceps JATHO..310
 naso pharyngeal forceps
 JURASZ.....311
 naso pharyngeal forceps
 St. CLAIR-THOMSON.....310
 nasolaryngoscope14
 needle BARBARA ROSEN...135, 136
 needle SHAMBOUGH.....135
 needle injection349
 needle laryngeal352
 needle tonsil CLAUD285
 needle tonsil DUPUY-WEISS285
 needle tonsil NAGER.....286
 needle tonsil210, 306, 344
 needle holder CRILE-WOOD209
 needle holder DERF.....209
 needle holder HALSEY.....209
 needle holder WEBSTER.....209
 needle holder
 WEBSTER-BABY209
 needle holder laryngeal349
 needle holder micro
 BARRAQUER.....123
 needle holder micro
 CASTROVIEJO.....124
 NEGUS tonsil forceps.....281
 NEGUS knot tier.....304
 NEGUS chest support280
 NEIVERT-ANDERSO
 rhinoplasty chisel.....233
 NEWS tracheal hook.....315
 noise apparatus BARANY60
 NON STICK bipolar forceps40, 41
 NOYES nasal dressing forceps....155
 nystagmus spectacle FRENZEL22
- O**
 O BRIEN stitch scissors199
 OBWEGESER osteotome234
 operating scissors IRIS.....117, 192
 operating scissors STANDARD117
 operation laryngoscope
334, 335, 340, 341
 osteotome COTTLE.....100
 osteotome LEXER.....228
 osteotome LEXER MINI100
 osteotome MINI-LAMBOTTE
99, 229
- osteotome OBWEGESER234
 osteotome RUBIN.....234
 osteotome WEST236
 osteotome98
 osteotome septum SHEEHAN.....101
 otoscope17
- P**
 palate retractor HOFER.....289
 palate retractor NAGER.....289
 PARKES nasal rasp.....238
 PARTSCH chisel99
 PARTSCH gouge99
 PARTSCH mallet102, 260
 PASSOW bone tamper.....98, 235
 PECK-JOSEPH face lift scissors..201
 PEET nasal rasp.....238
 PENNINGTON septum elevator...224
 PERWITZSCHKY
 salival scissors.....298
 pharyngoscope16
 PIERCE septum elevator.....223
 plastic mallet260
 PLESTER suction tube.....126
 PLESTER hook137
 PLESTER knife122
 PLESTER retractor112, 264
 POLITZER tympanum knife.....70, 71
 POLITZER air specula53
 POLITZER air bag61
 polypus laryngeal snare.....319
 POTTS-SMITH dressing forceps..294
 POTTS-SMITH tissue forceps.....294
 powder blower KABIERSKE.....60
 powder blower UNIVERSAL.....60
 pressure forceps
 HOUSE-GELFOAM.....85
 PRINCE tonsil scissors.....296
 probe ear STACKE63
 probe lachrymal BOWMAN262
 probe salivary duct BOWMAN.....293
 punch HAJEK-KOFLER.....182, 183
 punch KERRISON109, 182
 punch antrum184, 185
 punch biopsy179
 punch bone CITELLI.....109
 punch bone
 FERRIS-SMITH-KERRISON181
 punch circular186
 punch malleus DIETER84
 punch tonsil HARTMANN.....307
- Q**
 QUERVAIN elevator86
 QUIRE foreign body lever.....73
 QUISLING mallet260
- R**
 RAGNELL dissecting scissors.....191
 rasp nasal AUFRICHT239
 rasp nasal COTTLE.....239
 rasp nasal DINGMANN244
 rasp nasal FOMON.....240, 241
 rasp nasal GALLAHER.....243
 rasp nasal GLABELLA.....238
 rasp nasal JOSEPH.....238, 239
 rasp nasal LEWIS.....239
 rasp nasal MALTZ238, 239
 rasp nasal MASING242
 rasp nasal PARKES.....238
 rasp nasal PEET.....238
 rasp nasal WIENER.....238
 raspatory FARABEUF.....90
 raspatory suction GUILLEN.....227
 raspatory JANSEN91
 raspatory JOSEPH.....88
 raspatory KÖNIG.....86
 raspatory LANGENBECK86
 raspatory LEMPENR88
 raspatory MILLER.....92
 raspatory MOLT.....92
 raspatory ROSEN.....93
 raspatory WILLIGER87
 raspatory WULLSTEIN92
 raspatory86-93, 138, 227
 REDA cotton applicator64
 REDA sickle knife217
 REDA nasal specula.....144
 REDA retractor249
 REICHERT epiglottis retractor....343
 REINER ear syringe61
 retractor ADSON.....111
 retractor ALM.....109
 retractor BARSKY.....248
 retractor BERGMANN250
 retractor BRÜNNINGS-BRUNK263
 retractor COTTLE254
 retractor FINSEN109
 retractor FISCH111, 265
 retractor FRAZIER246
 retractor FREER254
 retractor GILLIES.....254
 retractor GRAEFE246
 retractor GUTHRIE.....246

retractor HOLZHEIMER.....109	rhinoplasty chisel SILVER233	scissors CONVERSE194
retractor HUMBY248	RING tongue depressor.....272	scissors COTTLE194
retractor JANSEN.....109	RITTER-HALLE sinus dilator.....261	scissors GRADLE.....195
retractor JOSEPH.....247	rod measuring HOUSE.....132	scissors GRAEFE.....194
retractor KLEINERT-KUTZ247	ROEDER "E" tonsil snare.....303	scissors KNAPP193
retractor KNAPP250	ROGER septum elevator.....222	scissors LITTLER194
retractor	ROLLET retractor250	scissors STEVENS.....196
KOCHER-LANGENBECK263	rongeur bone	scissors WAGNER197
retractor LAHEY246	BANE-HARTMANN106	scissors WALTER194
retractor LEYLA148	rongeur bone BEYER.....107	scissors WILMER194
retractor LUCAE250	rongeur bone BLUMENTHAL.....106	scissors blepharoplasty
retractor MIDDELDORPF263	rongeur bone BÖHLER107, 108	GREENBERG-PAR202
retractor MOLLISON.....111	rongeur bone	scissors blepharoplasty KAYE.....202
retractor PLESTER.....112, 264	COTTLE-KAZANJIAN108	scissors dissecting GORNEY116
retractor REDA249	rongeur bone KLEINERT-KUTZ...107	scissors dissecting JAMESON.....191
retractor ROLLET250	rongeur bone LEMPert107	scissors dissecting
retractor ROUX-BABY263	rongeur bone LUER.....106	JOSEPH116, 190
retractor WEITLANER110	rongeur bone MC INDOE108	scissors dissecting KELLY.....191
retractor	rongeur bone ZAUFAL-JANSEN ..107	scissors dissecting KILNER.....191
WEITLANER-WULLSTEIN.....110	ROSEN needle BARBARA...135, 136	scissors dissecting
retractor WILLIGER.....113	ROSEN suction tube129	METZENBAUM115, 188, 189, 297
retractor WULLSTEIN.....112	ROSEN knife120, 121	scissors dissecting
retractor alar CONVERSE252	ROSEN raspatory93	METZENBAUM FINO.....115, 189
retractor alar COTTLE252, 253	ROSER-KOENIG mouth gag.....271	scissors dissecting RAGNELL.....191
retractor alar	ROUX-BABY retractor263	scissors dissecting REYNOLDS...191
COTTLE-NEIVERT.....252	RUBIN morselizer forceps.....161	scissors dissecting
retractor alar FOMON.....253	RUBIN osteotome234	SANVENERO190
retractor alar KILNER253	RUSSEL-DAVIS tongue blades....278	scissors dissecting
retractor cheek STERNBERG270	RYDEL-SEIFFERT tuning fork59	STRABISMUS116, 196
retractor cheek270		scissors face lift BEUSE.....201
retractor epiglottis REICHERT.....343		scissors face lift GORNEY.....200
retractor finger ring COTTLE255	S	scissors face lift
retractor nasal AUFRICHT.....251	salival scissors	GORNEY-FREEMAN200
retractor nasal COTTLE251	PERWITZSCHKY.....298	scissors face lift KAYE.....201
retractor nasal MASING251	salivary duct probe BOWMAN.....293	scissors face lift PECK-JOSEPH..201
retractor nasal	SANVENERO	scissors laryngeal KILLIAN.....343
MASING-NEIVERT.....251	dissecting scissors.....190	scissors micro119, 131, 203-205
retractor palate HOFER.....289	saw nasal JOSEPH.....244, 245	scissors micro ear BELLUCCI.....80
retractor palate NAGER.....289	saw nasal LINDEMANN245	scissors micro ear FISCH.....82
retractor thyroid SCHOENBORN..317	SAWTELL tonsil forceps.....281	scissors micro ear GREVEN81
retractor uvula LOTHROP288	SCHEINMANN tip354	scissors micro ear McGHEE.....81
retractor uvula LOVE288	SCHINK dermatome220	scissors micro ear SCHUKNECHT.81
REYNOLDS dissecting scissors...191	SCHMEDEN	scissors micro ear SHEA.....80
rhinoplasty chisel CINELLI232	nasal cutting forceps.....169	scissors micro ear WULLSTEIN....83
rhinoplasty chisel COTTLE.....231	SCHNIDT tonsil forceps281	scissors nasal CAPLAN.....206
rhinoplasty chisel FOMON.....232	SCHOENBORN	scissors nasal COTTLE.....198
rhinoplasty gouge HAJEK.....236	thyroid retractor317	scissors nasal COTTLE-MASING 198
rhinoplasty gouge	SCHUKNECHT	scissors nasal FOMON.....198
KILLIAN-CLAUS236	micro ear scissors.....81	scissors nasal HEYMANN198
rhinoplasty chisel	SCHUKNECHT bending device85	scissors nasal187
NEIVERT-ANDERSO233	SCHUKNECHT knife122	scissors operating IRIS.....117, 192
rhinoplasty chisel SHEEHAN.....232	SCHUMACHER tip354	scissors operating STANDARD117
	scissors BONN192	

- scissors salival
 PERWITZSCHKY298
 scissors stitch LITTAUER199
 scissors stitch O BRIEN199
 scissors stitch SPENCER.....199
 scissors tonsil BOETTCHER.....296
 scissors tonsil DEAN296
 scissors tonsil GOOD296
 scissors tonsil PRINCE.....296
 scissors tumor207
 scissors wire UNIVERSAL.... 118, 299
 scissors micro larangeal351
 SEBILEAU elevator86
 SEIFERT tip354
 seizing forceps LAHEY.....318
 SEMKEN dressing forceps.....95
 SEMKEN tissue forceps95
 septum elevator BALLENGER225
 septum elevator COTTLE.....224, 225
 septum elevator
 COTTLE-JOSEPH.....224
 septum elevator FREER.....223
 septum chisel FREER230
 septum elevator
 HAJEK-BALLENGER225
 septum elevator HALLE.....222
 septum elevator HOWARTH.....224
 septum elevator JOSEPH.....222
 septum elevator KILLIAN.....223, 225
 septum elevator MASING.....222
 septum elevator McKENTY ..222, 224
 septum elevator PENNINGTON...224
 septum elevator PIERCE.....223
 septum elevator ROGER.....222
 septum osteotome SHEEHAN.....101
 septum elevator SINUS223
 septum cannula210, 306, 344
 septum fracture elevator
 GOLDMANN.....226
 septum straightening forceps
 ASCH.....160
 septum straightening forceps
 WALSHAM160
 septum swivel knife
 BALLENGER.....218
 SEWALL antrum elevator226
 SEXTON tympanum knife71
 SHAMBOUGH needle135
 SHAPLEIGH ear loop.....67
 SHEA micro ear scissors.....80
 SHEA spoon134
 SHEEHAN rhinoplasty chisel.....232
 SHEEHAN septum osteotome.....101
 sickle knife REDA217
 SIEGLE ear specula set56
 SILVER rhinoplasty chisel233
 SILVER dermatome221
 sinus dilator RITTER-HALLE.....261
 SINUS nasal elevator261
 SINUS septum elevator.....223
 sinuscope15
 sinuscopy trocar UNIVERSAL.....214
 SLUDER-BALLENGER
 tonsillectome305
 snare ear polypus KRAUSE72
 snare ear polypus WILDE.....72
 snare nasal polypus KRAUSE.....162
 snare nasal polypus
 KRAUSE-VOSS.....162
 snare nasal polypus WILDE163
 snare tonsil BRUENINGS.....301
 snare tonsil EVES.....301
 snare tonsil ROEDER "E"303
 snare tonsil TYDING.....300
 snare laryngeal polypus.....319
 spare bulb22
 spare bulb laryngoscope332, 333
 specula ear BOUCHERON.....53
 specula ear GRUBER.....53
 specula ear HARTMANN.....53
 specula ear55, 56
 specula ear FARRIOR.....54
 specula ear POLITZER53
 specula ear TOYNBEE53
 specula nasal COTTLE146, 147
 specula nasal HARTMANN142
 specula nasal
 HARTMANN-HALLE.....141
 specula nasal KILLIAN144, 145
 specula nasal REDA.....144
 specula nasal THUDICHUM.....140
 specula nasal TIECK-HALLE144
 specula nasal VOLTOLINI140
 specula nasal WIEN143
 SPENCER stitch scissors.....199
 spoon SHEA.....134
 spoon138
 spoon ear GROSS.....65
 SPRATT bone curette.....103
 spreader tracheal BOSE.....314, 315
 St. CLAIR-THOMSON
 adenoid curette.....309
 St. CLAIR-THOMSON
 naso pharyngeal forceps310
 STACKE ear probe.....63
 STANDARD dressing forceps.....95
 STANDARD operating scissors....117
 STERNBERG cheek retractor270
 STEVENS scissors196
 stitch scissors LITTAUER199
 stitch scissors O BRIEN199
 stitch scissors SPENCER.....199
 stitch bipolar electrode.....44, 45
 STRABISMUS
 dissecting scissors.....116, 196
 STRUYCKEN
 nasal cutting forceps.....169
 suction tube BARON128
 suction tube FERGUSSON213
 suction tube
 FRAZIER/FERGUSSON125, 213
 suction tube PLESTER.....126
 suction tube ROSEN129
 suction tube WULLSTEIN.....127
 suction handle WULLSTEIN.....129
 suction tube YANKAUER.....284
 suction tube YANKAUER BABY ...284
 suction tube ZÖLLNER.....125
 suction tube348
 suction coagulation tube.....211
 suction monopolar coagulator43
 suction raspatory GUILLEN.....227
 suction tube HOUSE126, 214
 suction bipolar forceps.....42
 suction laryngeal elevator.....352
 syringe ear REINER61
 syringe ear62
 syringe tonsil210, 306, 344

T
 TABB knife122
 TAKAHASHI ethmoid forceps.....165
 tamper98
 tamper bone PASSOW.....98, 235
 THILENIUS
 tonsil abscess forceps283
 THUDICHUM nasal specula.....140
 thyroid dissector KOCHER317
 thyroid retractor SCHOENBORN..317
 TIECK-HALLE nasal specula144
 tier knot NEGUS.....304
 tier laryngeal knot352
 TILLEY ear forceps.....74
 TILLEY nasal dressing forceps....155
 tip BARACANI354
 tip BRUENINGS354

tip CORDES	354	tonsil dissector HURD	290	tube suction	348
tip FRAENKEL.....	354	tonsil dissector LOPEZ-REINKE ..	290	tube suction HOUSE	126, 214
tip KRAUSE	354	tonsil forceps MARSCHIK	282	tube tracheal	
tip LANGE.....	354	tonsil forceps MIKULICZ	283	WAGENER-MOSHER	315
tip SCHEINMANN.....	354	tonsil needle NAGER	286	tube coagulation suction.....	211
tip SCHUMACHER	354	tonsil forceps NEGUS.....	281	tumor scissors	207
tip SEIFERT.....	354	tonsil scissors PRINCE.....	296	tuning fork HARTMANN	58
tissue forceps ADSON.....	97	tonsil snare ROEDER "E"	303	tuning fork LUCAE.....	59
tissue forceps DERLACKI	97	tonsil forceps SAWTELL.....	281	tuning fork RYDEL-SEIFFERT	59
tissue forceps POTTS-SMITH.....	294	tonsil forceps SCHNIDT	281	tuning fork	58, 59
tissue forceps SEMKEN	95	tonsil forceps TYDING.....	282	TYDING tonsil forceps.....	282
TOBOLD tongue depressor	270	tonsil snare TYDING.....	300	TYDING tonsil snare.....	300
tongue depressor ANDREW.....	269	tonsil forceps WHITE.....	281	tymanum knife LUCAE	70
tongue depressor BRUENINGS ..	268	tonsil elevator YANKAUER	290	tymanum knife POLITZER.....	70, 71
tongue depressor BUCHWALD ..	268	tonsil wire	302	tymanum knife SEXTON	71
tongue depressor		tonsil syringe	210, 306, 344		
CAWOOD-MINNESOTA.....	268	tonsil needle	210, 306, 344		
tongue depressor		tonsil abscess forceps		U	
DAVIS-BOYLE.....	273	THILENIUS.....	283	UCKERMANN cotton applicator	64
tongue blades DOUGHTY	279	tonsillectome		UNIVERSAL wire scissors....	118, 299
tongue depressor FRENZEL	268	SLUDER-BALLENGER	305	UNIVERSAL trocar sinuscopy	214
tongue depressor HARTMANN ..	269	TOYNBEE ear specula.....	53	UNIVERSAL powder blower	60
tongue depressor KROENIG.....	268	tracheal spreader BOSE.....	314, 315	uvula retractor LOTHROP	288
tongue depressor		tracheal cannula		uvula retractor LOVE	288
MORITZ-SCHMIDT	269	CHEVALIER-JACKSON	316		
tongue depressor RING.....	272	tracheal hook ITERSON	315	V	
tongue blades RUSSEL-DAVIS.....	278	tracheal hook JACKSON.....	314	VOLKMANN bone curette	104
tongue depressor TOBOLD	270	tracheal dilator LABORDE.....	314	VOLTOLINI nasal specula	140
tongue depressor WIEDER	269	tracheal cannula LUER.....	316		
tongue forceps YOUNG.....	270	tracheal hook NEWS	315	W	
tongue depressor	268	tracheal dilator TROUSSEAU.....	314	WAGENER ear hook.....	66
tongue forceps COLLIN.....	270	tracheal dilator		WAGENER-MOSHER	
tonsil forceps ABRAHAM.....	282	TROUSSEAU-BABY	314	tracheal tube.....	315
tonsil knife ABRAHAM	287	tracheal tube		WAGNER scissors	197
tonsil dissector ALDERDYCE	290	WAGENER-MOSHER	315	WALSHAM septum straightening	
tonsil forceps BALLENGER.....	281	trocar COAKLEY	215	forceps.....	160
tonsil forceps BLOHMKE.....	281	trocar LICHTWITZ	215	WALTER chisel	235
tonsil scissors BOETTCHER.....	296	trocar sinuscopy UNIVERSAL.....	214	WALTER scissors	194
tonsil knife BRUENINGS	287	TROELTSCH nasal forceps.....	149	WATSON dermatome	221
tonsil snare BRUENINGS.....	301	TROUSSEAU tracheal dilator.....	314	WATSON-WILLIAMS	
tonsil knife CANFIELD.....	287	TROUSSEAU-BABY		ethmoid forceps	166
tonsil enucleator CARPENTER ..	291	tracheal dilator.....	314	WEBER-LOCH ear loop.....	67
tonsil needle CLAUS	285	tube suction BARON	128	WEBSTER needle holder	209
tonsil forceps COLVER.....	281	tube suction FERGUSSON	213	WEBSTER-BABY needle holder ..	209
tonsil scissors DEAN	296	tube suction		WEIL-BLAKESLEY	
tonsil forceps DENIS BROWNE ..	283	FRAZIER/FERGUSSON	125, 213	ethmoid forceps	164
tonsil needle DUPUY-WEISS	285	tube suction PLESTER.....	126	WEIL-BLAKESLEY	
tonsil snare EVES.....	301	tube suction ROSEN	129	nasal cutting forceps.....	168
tonsil knife FISHER	286	tube suction WULLSTEIN.....	127	WEITLANER retractor	110
tonsil scissors GOOD	296	tube suction YANKAUER.....	284	WEITLANER-WULLSTEIN	
tonsil punch HARTMANN	307	tube suction YANKAUER BABY ..	284	retractor	110
tonsil elevator HENKE	290	tube suction ZÖLLNER.....	125	WEST gouge	236
				WEST osteotome	236

WESTMACOTT	
nasal dressing forceps.....	154
WHITE tonsil forceps.....	281
WIEDER tongue depressor	269
WIEN nasal specula	143
WIENER nasal rasp.....	238
WILDE ear polypus snare.....	72
WILDE nasal polypus snare	163
WILDE (TROELTSCH)	
ear forceps.....	94
WILDE (TROELTSCH)	
nasal forceps	152
WILDER lachrial dilator	261
WILLIGER bone curette	105
WILLIGER raspatory	87
WILLIGER retractor	113
WILMER scissors	194
wire scissors UNIVERSAL....	118, 299
wire tonsil	302
WULLSTEIN suction handle.....	129
WULLSTEIN micro ear scissors	83
WULLSTEIN suction tube.....	127
WULLSTEIN knife	122
WULLSTEIN raspatory	92
WULLSTEIN retractor	112
Y	
YANKAUER tonsil elevator.....	290
YANKAUER suction tube.....	284
YANKAUER BABY suction tube ...	284
YASARGIL ear specula holder	57
YOUNG tongue forceps.....	270
Z	
ZAUFAL ear loop	65
ZAUFAL-JANSEN ear elevator.....	65
ZAUFAL-JANSEN bone rongeur ..	107
ZIEGLER head mirror.....	23
ZÖLLNER suction tube.....	125
bipolar cable	39
light guide cable.....	19
laryngeal cannula	210, 306, 344
septum cannula	210, 306, 344
cotton carrier.....	347
antrum curette	256, 257
tongue depressor.....	268
biopsy forceps	15
bipolar forceps.....	36, 37, 38
dressing forceps	295
jeweler forceps	96
maxillary sinus forceps	176, 177
micro ear forceps...75, 76, 77, 78, 79	
nasal forceps	167, 180
nasal cutting forceps.....	170-174, 178
tuning fork.....	58, 59
laryngeal handle	346
laryngoscope handle	332, 333
ear hook.....	65, 66
laryngeal hook	352, 353
laryngeal instrument handle	353
laryngeal knife	352, 353
fibreglass laryngoscope.....	339
operation laryngoscope	
.....	334, 335, 340, 341
laryngeal mirror.....	346
injection needle.....	349
laryngeal needle	352
tonsil needle	210, 306, 344
laryngeal needle holder	349
FRENZEL nystagmus spectacle....	22
mallet plastic.....	260
antrum punch.....	184, 185
biopsy punch	179
circular punch	186
cheek retractor.....	270
micro scissors.....	119, 131, 203-205
nasal scissors	187
tumor scissors	207
laryngoscope spare bulb	332, 333
ear specula	55, 56
ear syringe.....	62
tonsil syringe.....	210, 306, 344
suction tube	348
tonsil wire.....	302

A	ANTRUM cureta256	BARBARA / ROSEN aguja... 135, 136
ABRAHAM bisturi287	articulacion335	BARBARA gancho..... 135, 136
ABRAHAM pinza282	articulacion esferica.....148	BARBON-LUBET pinza 154
abre-boca271, 274-277, 280	asa65, 67, 72, 163	BARNHILL cuchillo308
abre-boca BOYLE-DAVIS274	asa BILLEAU65	BARON tubo de aspiracion128
abre-boca DAVIS-BOYLE274	asa LANGENBECK65	BARRAQUER porta aguja.....123
abre-boca DAVIS-MEYER277	asa LOCH-WEBER67	BARSKY gancho248
abre-boca DENHART271	asa SHAPLEIGH67	BARTH cucharilla104
abre-boca DINGMANN276	asa WEBER-LOCH67	BECKMANN cuchillo308
abre-boca DOUGHTY-KILNER275	ASCH pinza160	BELLUCCI tijera80
abre-boca	AUFRICTH escofina239	BERGMANN gancho.....250
DOYEN-JANSEN (MOLT)271	AUFRICTH retractor251	BEUSE tijera.....201
abre-boca HEISTER271	auricular especulo53-56	BEYER pinza gubia107
abre-boca	auricular pinza74-79	BILLEAU asa65
JANSEN-DOYEN (MOLT)271		bipolar cable39
abre-boca JENNINGS271	B	bipolar electrodo44-45
abre-boca KILNER-DOUGHTY275	BABY ROUX separador263	bipolar pinza36-38, 40-42
abre-boca KOENIG-ROSER271	BABY-TROUSSEAU dilatador314	bipolar pinza de succion42
abre-boca MAUNDER280	BABY-WEBSTER porta aguja209	bisturi216-219, 286-287
abre-boca McIVOR277	BABY-YANKAUER	bisturi ABRAHAM287
abre-boca MEYER-DAVIS277	tubo de succion284	bisturi BALLENGER218
abre-boca	baja nudos352	bisturi BRUENINGS287
MOLT (DOYEN-JANSEN)271	baja-lengua	bisturi CANFIELD287
abre-boca ROSER-KOENIG271268-270, 272-273, 275-279	bisturi CONVERSE217
acoplamiento148	baja-lengua ANDREW269	bisturi COTTLE217
adaptador20, 24-25, 129	baja-lengua BOYLE-DAVIS273	bisturi FISHER286
adaptador HOUSE129	baja-lengua BRUENINGS268	bisturi FREER216
adenotomo LAFORCE309	baja-lengua BUCHWALD268	bisturi JOSEPH216-217
ADSON pinza97	baja-lengua DAVIS-BOYLE273	bisturi REDA217
ADSON separador112	baja-lengua DAVIS-RUSSEL278	BLAKESLEY pinza180
aguja70-71, 135-136, 210,	baja-lengua DINGMANN276	BLAKESLEY-WEIL pinza.....164, 168
.....285-286, 306, 344, 352-353	baja-lengua DOUGHTY279	BLOHMKE pinza281
aguja BARBARA / ROSEN... 135, 136	baja-lengua DOUGHTY-KILNER ..275	BLUMENTHAL pinza gubia106
aguja CLAUS285	baja-lengua FRENZEL268	BOETTCHEER tijera.....296
aguja DUPUY-WEISS285	baja-lengua HARTMANN269	BÖHLER pinza gubia107-108
aguja LUCAE70	baja-lengua KILNER-DOUGHTY ..275	BOIES elevador226
aguja NAGER286	baja-lengua KROENING268	bombilla22, 26, 27, 332-333
aguja POLITZER70-71	baja-lengua McIVOR277	BONN tijera192
aguja ROSEN / BARBARA... 135, 136	baja-lengua MORITZ-SCHMIDT ..269	BOSE gancho.....315
aguja WEISS-DUPUY285	baja-lengua RUSSEL-DAVIS.....278	BOSE separador314
alambre para polipotomo.....319	baja-lengua SCHMIDT-MORITZ..269	BOUCHERON especulo auricular ..53
ALDERDYCE elevador.....290	baja-lengua TOBOLD270	BOWMAN sonda262, 293
ALM separador110	baja-lengua WIEDER269	BOYLE-DAVIS abre-boca.....274
amigdalotomo	BALLENGER bisturi218	BOYLE-DAVIS baja-lengua273
BALLENGER-SLUDER305	BALLENGER elevador225	brazo de soporte.....148
amigdalotomo	BALLENGER pinza281	brazo flexible57
SLUDER-BALLENGER305	BALLENGER-HAJEK elevador ...225	broca.....30-31
ANDERSON-NEIVERT	BALLENGER-SLUDER	broncoscopio18
osteotomo233	amigdalotomo305	BROWNE DENIS pinza283
ANDREW baja-lengua.....269	BANE-HARTMANN pinza gubia...106	BRUENINGS baja-lengua268
anillo335	BARACANI punta354	BRUENINGS bisturi287
anteojos FRENZEL.....22	BARANY ensordecedor.....60	BRUENINGS cierranudo301

BRUENINGS especulo auricular.....	55
BRUENINGS pinza.....	158
BRUENINGS punta.....	354
BRUENINGS tubo de extension...	354
BRÜNING-SBRUNK separador ...	263
BRÜNING-SLUCAS gubia.....	98
BRUNK-BRÜNING-S separador.....	263
BUCHWALD baja-lengua.....	268
BUCK cureta.....	68-69
BUCK elevador.....	73

C

cabla.....	19, 39
cabla bipolar.....	39
CANFIELD bisturi.....	287
canula CHEVALIER-JACKSON.....	316
canula de inyeccion.....	337, 349
canula de succion.....	338
canula JACKSON-CHEVALIER.....	316
canula LUER.....	316
canula MOSHER-WAGENER.....	315
canula para laringe.....	210, 306, 344
canula traqueal.....	315-316
canula WAGENER-MOSHER.....	315
CAPLAN tijera.....	206
CARPENTER disector.....	291
CARPENTER enucleador.....	291
CASTROVIEJO porta aguja.....	124
cateter.....	70
cateter HARTMANN.....	70
CAWOOD-MINNESOTA separador.....	268
CHEVALIER-JACKSON canula.....	316
CHEVALIER-JACKSON pinza para bronco-esofagoscopia.....	356
cierranudo.....	300-301, 303, 319
cierranudo BRUENINGS.....	301
cierranudo EVES.....	301
cierranudo ROEDER "E".....	303
cierranudo TYDING.....	300
cincel.....	98-100, 230-233, 235-236
cincel CINELLI.....	232
cincel CLAUS-KILLIAN.....	236
cincel COTTLE.....	100, 231
cincel FOMON.....	232
cincel FREER.....	100, 230, 236
cincel HAJEK.....	236
cincel KILLIAN-CLAUS.....	236
cincel PARTSCH.....	99
cincel PASSOW.....	98, 235
cincel SILVER.....	233
cincel WALTER.....	235

cincel WEST.....	236
CINELLI cincel.....	232
cinta.....	23
CITELLI pinza sacabocado.....	109
CLAR lampara frontal.....	26
CLAUS aguja.....	285
CLAUS-KILLIAN cincel.....	236
coagulador de succion monopolar..	43
COAKLEY cureta.....	256
COAKLEY trocar.....	215
COLLIN pinza.....	270
COLVER pinza.....	281
cono.....	61
CONVERSE bisturi.....	217
CONVERSE gancho.....	252
CONVERSE/WILMER/ WALTER tijera.....	194
CORDES punta.....	354
COTTLE (MALTZ) escofina.....	239
COTTLE bisturi.....	217
COTTLE cincel.....	100, 231
COTTLE elevador.....	224-225
COTTLE especulo nasal.....	146-147
COTTLE gancho.....	252-255
COTTLE machacadora.....	237
COTTLE martillo.....	102, 260
COTTLE pinza.....	94, 152-153
COTTLE retractor.....	251
COTTLE tijera.....	194, 198
COTTLE-KAZANJIAN pinza gubia.....	108, 208
COTTLE-MASING tijera.....	198
COTTLE-NEIVERT gancho.....	252
CRAIG pinza.....	158
CRAIG-DOMNICK pinza.....	158
CRILE-WOOD porta aguja.....	209
cucharilla	103-105, 134, 138, 257-258
cucharilla BARTH.....	104
cucharilla DAUBENSPECK.....	258
cucharilla HALLE.....	104, 258
cucharilla JANSEN.....	103
cucharilla LEMPERS.....	103
cucharilla MARTINI.....	105
cucharilla para antro.....	257
cucharilla SHEA.....	134
cucharilla SPRATT.....	103
cucharilla VOLKMANN.....	104
cucharilla WILLIGER.....	105
cuchillo.....	71, 120-122, 219, 308-309, 352-353
cuchillo BARNHILL.....	308

cuchillo BECKMANN.....	308
cuchillo FREER-INGALS.....	219
cuchillo INGALS-FREER.....	219
cuchillo MASING.....	219
cuchillo PLESTER.....	122
cuchillo POLITZER.....	71
cuchillo ROSEN.....	120
cuchillo SCHUKNECHT.....	122
cuchillo SEXTON.....	71
cuchillo St. CLAIR-THOMSON.....	309
cuchillo TABB.....	122
cuchillo THOMSON-St. CLAIR.....	309
cuchillo WULLSTEIN.....	122
cureta.....	65, 68-69, 133, 256
cureta ANTRUM.....	256
cureta BUCK.....	68-69
cureta COAKLEY.....	256
cureta FAULKNER.....	256
cureta HOUSE.....	133
cureta y gancho GROSS.....	65

D

DAUBENSPECK cucharilla.....	258
DAVIS-BOYLE abre-boca.....	274
DAVIS-BOYLE baja-lengua.....	273
DAVIS-MEYER abre-boca.....	277
DAVIS-RUSSEL baja-lengua.....	278
DAY gancho.....	66
DEAN tijera.....	296
DENHART abre-boca.....	271
DENIS BROWNE pinza.....	283
depresor REICHERT.....	343
DERF porta aguja.....	209
DERLACKI pinza.....	97
dermatomo HUMBY.....	221
dermatomo SCHINK.....	220
dermatomo SILVER.....	221
dermatomo WATSON.....	221
diapason.....	58-59
diapason LUCAE.....	59
diapason RYDEL-SEIFFERT.....	59
DIETER pinza.....	84
dilatador.....	261, 314
dilatador BABY-TROUSSEAU.....	314
dilatador LABORDE.....	314
dilatador TROUSSEAU.....	314
dilatador TROUSSEAU-BABY.....	314
dilatador WILDER.....	261
DINGMAN lima.....	130, 244
DINGMANN abre-boca.....	276
DINGMANN baja-lengua.....	276
disector.....	93, 290-291

disector CARPENTER.....	291	elevador SEWALL.....	226	espejo laringeal MICHEL.....	345
disector FISCH.....	93	elevador SINUS.....	223	estuche diagnostico.....	48-52
disector HURD.....	290	elevador YANKAUER.....	290	estuche diagnostico ECO.....	51
disector LOPEZ-REINKE.....	290	elevador ZAUFAL.....	65	estuche diagnostico RI-MINI.....	52
disector REINKE-LOPEZ.....	290	elevador ZAUFAL-JANSEN.....	65	estuche diagnostico UNI III.....	50
dispositivo de fijacion para tubos		endolaringeal endoscopio.....	18	EVES cierranudo.....	301
.....	57, 148	endoscopio.....	15-18		
dispositivo para modelar		endoscopio endolaringeal.....	18	F	
SCHUKNECHT.....	85	ensordecador BARANY.....	60	FARABEUF periostotomo.....	90
DOMNICK-CRAIG pinza.....	158	enucleador CARPENTER.....	291	faringoscopia.....	16
DOUGHTY baja-lengua.....	279	escofina.....	238-244	FARRELL porta-algodon.....	63
DOUGHTY-KILNER abre-boca.....	275	escofina AUFRIEHT.....	239	FARRIOR espejulo auricular.....	54
DOUGHTY-KILNER baja-lengua.....	275	escofina COTTLE (MALTZ).....	239	FAULKNER cureta.....	256
DOYEN-JANSEN (MOLT)		escofina FOMON.....	240-241	FEIN porta-algodon.....	347
abre-boca.....	271	escofina GALLAHER.....	243	FERGUSSON / FRAZIER	
DUPLAY pinza.....	295	escofina GLABELLA.....	238	tubo de aspiracion.....	125, 213
DUPUY-WEISS aguja.....	285	escofina JOSEPH.....	238	FERGUSSON tubo de aspiracion	213
		escofina JOSEPH (LEWIS).....	239	FERRIS-SMITH-KERRISON	
E		escofina LEWIS (JOSEPH).....	239	pinza.....	181
ECO estuche diagnostico.....	51	escofina MALTZ.....	238	FINSEN separador.....	110
EICKEN (KILLIAN)		escofina MALTZ (COTTLE).....	239	FISCH disector.....	93
tubo de aspiracion.....	212	escofina MASING.....	242	FISCH separador.....	112, 265
Electrocirugia.....	34-38, 40-45	escofina PARKES.....	238	FISCH tijera.....	82
electrodo.....	34-35, 44-45	escofina PEET.....	238	FISHER bisturi.....	286
electrodo bipolar.....	44-45	escofina WIENER.....	238	FOMON cincel.....	232
electrodo bipolar MICRODOME.....	45	especulo auricular.....	53-56	FOMON escofina.....	240-241
elevador.....	65, 73, 86, 88, 91-92,	especulo auricular BOUCHERON.....	53	FOMON gancho.....	253
.....	138, 222-226, 290	especulo auricular BRUENINGS.....	55	FOMON tijera.....	198
elevador ALDERDYCE.....	290	especulo auricular FARRIOR.....	54	FRAENKEL pinza.....	342
elevador BALLENGER.....	225	especulo auricular GRUBER.....	53	FRAENKEL punta.....	354
elevador BALLENGER-HAJEK.....	225	especulo auricular HARTMANN.....	53	FRAZIER / FERGUSSON	
elevador BOIES.....	226	especulo auricular POLITZER.....	53	tubo de aspiracion.....	125, 213
elevador BUCK.....	73	especulo auricular SIEGLE.....	56	FRAZIER gancho.....	246
elevador COTTLE.....	224-225	especulo auricular TOYNBEE.....	53	FREEMAN-GORNEY tijera.....	200
elevador FREER.....	91, 223	especulo nasal.....	140-147	FREER bisturi.....	216
elevador GOLDMANN.....	226	especulo nasal COTTLE.....	146-147	FREER cincel.....	100, 230, 236
elevador HAJEK-BALLENGER.....	225	especulo nasal		FREER elevador.....	91, 223
elevador HALLE.....	222	HALLE-HARTMANN.....	141	FREER gancho.....	254
elevador HENKE.....	290	especulo nasal HALLE-TIECK.....	144	FREER-INGALS cuchillo.....	219
elevador HOWARTH.....	224	especulo nasal HARTMANN.....	142	FRENZEL anteojos.....	22
elevador JANSEN-ZAUFEL.....	65	especulo nasal		FRENZEL baja-lengua.....	268
elevador JOSEPH.....	222	HARTMANN-HALLE.....	141	FROHN porta-algodon.....	63
elevador KILLIAN.....	223, 225	especulo nasal KILLIAN.....	144-145	frontal lampara.....	24-27
elevador LEMPert.....	88, 91	especulo nasal Mod. WIEN.....	143	FRONTAL sonda.....	261
elevador MASING.....	222	especulo nasal REDA.....	144		
elevador McKENTY.....	92, 222, 224	especulo nasal THUDICHUM.....	140	G	
elevador PENNINGTON.....	224	especulo nasal TIECK-HALLE.....	144	GALLAHER escofina.....	243
elevador PIERCE.....	223	especulo nasal VOLTOLINI.....	140	gancho.....	65, 66, 135-137, 246-250,
elevador QUERVAIN.....	86	especulo nasal WIEN Mod.....	143	252-255, 314-315, 352-353
elevador QUIRE.....	73	espejo.....	23, 26	gancho BARBARA.....	135, 136
elevador ROGER.....	222	espejo frontal ZIEGLER.....	23	gancho BARSKY.....	248
elevador SEBILEAU.....	86	espejo laringeal.....	345-346	gancho BERGMANN.....	250

gancho BOSE	315	gubia LEXER MINI	100	HOUSE-GELFOAM pinza	85
gancho CONVERSE.....	252	gubia LUCAS-BRÜNINGS.....	98	HOWARTH elevador	224
gancho COTTLE.....	252-255	gubia MINI LEXER	100	HUBER mango.....	354
gancho COTTLE-NEIVERT	252	gubia PARTSCH.....	99	HUMBY dermatomo	221
gancho DAY	66	GUILEN legra	227	HUMBY gancho.....	248
gancho FOMON	253	GUILEN periostotomo	227	HURD disector.....	290
gancho FRAZIER	246	GUTHRIE gancho.....	246		
gancho FREER	254			I	
gancho GILLIES	254	H		INGALS-FREER cuchillo.....	219
gancho GRAEFE	246	HAJEK cincel.....	236	instrumento de aspiracion y	
gancho GUTHRIE.....	246	HAJEK martillo	102	irrigacion	210-211
gancho HUMBY	248	HAJEK-BALLENGER elevador	225	instrumento para laringoscopia	
gancho ITERSON	315	HAJEK-KOFLER pinza.....	182-183	352-353
gancho JACKSON.....	314	HALLE cucharilla.....	104, 258	insuflador de aire POLITZER	61
gancho JOSEPH.....	247	HALLE elevador	222	IRIS tijera.....	117, 192
gancho KILNER.....	253	HALLE-HARTMANN		ITERSON gancho.....	315
gancho KLEINERT-KUTZ.....	247	especulo nasal	141		
gancho KNAPP.....	250	HALLE-RITTER sonda.....	261	J	
gancho KUTZ-KLEINERT.....	247	HALLE-TIECK especulo nasal	144	JACKSON gancho.....	314
gancho LAHEY.....	246	HALSEY porta aguja	209	JACKSON laringoscopio	340
gancho LANGE.....	255	HARTMANN baja-lengua	269	JACKSON pinza laringeal	343
gancho LUCAE.....	66, 250	HARTMANN cateter	70	JACKSON-CHEVALIER canula.....	316
gancho McGEE	136	HARTMANN especulo auricular	53	JACKSON-CHEVALIER pinza	
gancho NEIVERT-COTTLE	252	HARTMANN especulo nasal	142	para bronco-esofagosocpia.....	356
gancho NEWS	315	HARTMANN pinza		JAMESON (REYNOLDS) tijera.....	191
gancho PLESTER	137	74-75, 154, 169, 175, 307	JANSEN cucharilla	103
gancho REDA	249	HARTMANN-BANE pinza gubia... 106		JANSEN periostotomo.....	91
gancho ROLLET.....	250	HARTMANN-HALLE		JANSEN pinza.....	150
gancho SHAMBAUGH	135	especulo nasal	141	JANSEN separador	110
gancho WAGENER	66	HARTMANN-HOFFMANN		JANSEN-DOYEN (MOLT)	
gancho y cureta GROSS.....	65	pinza.....	75, 175	abre-boca	271
GELFOAM-HOUSE pinza	85	HARTMANN-WEINGÄRTNER		JANSEN-GRUENWALD pinza	150
GERZOG martillo	259	pinza.....	75	JANSEN-MIDDLETON pinza	159
GILLIES gancho	254	HARTMANN-WULLSTEIN		JANSEN-ZAUFAL elevador.....	65
GILLIES pinza	151	pinza.....	75, 175	JANSEN-ZAUFAL pinza gubia	107
GLABELLA escofina	238	HEISTER abre-boca.....	271	JATHO pinza naso-faringea	310
GOLDMANN elevador.....	226	HENKE elevador	290	JENNINGS abre-boca	271
GOOD tijera	296	HEYMAN tijera	198	jeringa	61-62, 210, 306, 344
GORNEY tijera	116, 200	HEYMANN pinza.....	157	jeringa REINER	61
GORNEY-FREEMAN tijera.....	200	HEYMANN-KNIGHT pinza	156	JOBSON-HORNE porta-algodon ..	64
GRADLE tijera	195	hilo para amigdalas	302	JOSEPH (LEWIS) escofina	239
GRAEFE gancho.....	246	HOFER separador.....	289	JOSEPH bisturi.....	216-217
GRAEFE pinza	95, 151	HOFFMANN-HARTMANN		JOSEPH elevador	222
GRAEFE tijera	194	pinza.....	75, 175	JOSEPH escofina.....	238
grapa para iluminacion.....	338, 341	hoja de repuesto.....	220-221	JOSEPH gancho	247
GREENBERG-PAR tijera	202	HOLINGER laringoscopio.....	339	JOSEPH periostotomo	88
GREVEN tijera.....	81	HOLZHEIMER separador.....	110	JOSEPH sierra nasal.....	244-245
GROSS gancho y cureta.....	65	horquilla NEGUS	304	JOSEPH tijera	116, 190
GRUBER especulo auricular	53	HOUSE adaptador	129	JOSEPH-PECK tijera	201
GRUENWALD-JANSEN pinza	150	HOUSE cureta.....	133	JURASZ pinza	311, 342
gubia.....	98-100	HOUSE sonda.....	132		
gubia BRÜNINGS-LUCAS.....	98	HOUSE tubo de aspiracion ..	126, 214		

K	LANGENBECK periostotomo86	M	machacadora COTTLE.....237
KABIERSKE lanzapolvo60	LANGENBECK-KOCHER	MALTZ (COTTLE) escofina239	MALTZ escofina.....238
KAYE tijera201-202	separador263	MALTZ mango de pila332-333	mango de succion127, 129
KAZANJIAN-COTTLE	lanzapolvo60	mango de succion	WULLSTEIN127, 129
pinza gubia108, 208	lanzapolvo KABIERESKE60	MANGO HUBER354	mango para espejo laringeal346
KELLY tijera191	lanzapolvo UNIVERSAL60	mango para instrumentos	microlaringeos353
KERRISON	laringoscopio17	mango para laringoscopio332-333, 336
pinza sacabocado.....109, 182	laringoscopio . 322-331, 334, 339-341	MARSCHIK pinza282	martillo102, 259-260
KERRISON-FERRIS-SMITH	laringoscopio HOLINGER.....339	martillo COTTLE102, 260	martillo GERZOG259
pinza181	laringoscopio JACKSON340	martillo HAJEK102	martillo MEAD102, 259
KILLIAN (EICKEN)	laringoscopio McCOY.....324, 331	martillo PARTSCH102, 260	martillo QUISLING260
tubo de aspiracion212	laringoscopio McINTOSH	MARTINI cucharilla.....105	MASING cuchillo219
KILLIAN elevador223, 225322-323, 327-328	MASING elevador222	MASING escofina242
KILLIAN espejulo nasal144-145	laringoscopio MILLER	MASING-COTTLE tijera198	MASING-NEIVERT retractor251
KILLIAN porta-algodon.....347325-326, 329-330	MASTIN pinza318	MAUNDER abre-boca280
KILLIAN tijera343	laringoscopio operativo	MC INDOE pinza gubia108, 208	McGEE gancho136
KILLIAN tubo de aspiracion212334-335, 340-341	McGEE tijera81	McINDOE pinza.....151
KILLIAN-CLAUS cincel.....236	lazo65, 67	MCIIVOR abre-boca.....277	MCIIVOR baja-lengua277
KILNER (RAGNELL) tijera.....191	legra de succion353	McKENTY elevador92, 222, 224	MEAD martillo102, 259
KILNER gancho253	legra GUILLEN227	METZENBAUM FINO tijera..115, 189	METZENBAUM tijera
KILNER-DOUGHTY abre-boca275	LEMPERT cucharilla103115, 188-189, 297	MEYER-DAVIS abre-boca.....277
KILNER-DOUGHTY baja-lengua.....275	LEMPERT elevador88, 91	MICHEL espejo laringeal.....345	micro pinza131, 350-351
KLEINERT-KUTZ gancho247	LEMPERT pinza gubia107	micro tijera119, 131, 203-205, 351	MICRODOME electrodo bipolar45
KLEINERT-KUTZ pinza gubia107	LEWIS (JOSEPH) escofina239	MIDDLELORPF separador263	MIDDLETON-JANSEN pinza159
KNAPP gancho.....250	LEXER MINI gubia100	MIKULICZ pinza283	MILLER periostotomo.....92
KNAPP tijera.....193	LEXER MINI osteotomo100	MILLER periostotomo.....92	MINI LEXER gubia100
KNIGHT pinza157	LEXER osteotomo228	MINI LEXER osteotomo100	
KNIGHT-HEYMANN pinza156	LEYLA separador148		
KOCHER sonda317	LICHTWITZ trocar215		
KOCHER-LANGENBECK	lima130, 238-244		
separador263	lima DINGMAN130, 244		
KOENIG-ROSER abre-boca271	LINDEMANN sierra nasal.....245		
KOFLER-HAJEK pinza.....182-183	LISTER (SINUS) pinza155		
KÖNIG periostotomo86	LITTAUER pinza.....74, 156		
KRAUSE polipotomo72, 162	LITTAUER tijera.....199		
KRAUSE punta.....354	LITTLER tijera194		
KRAUSE-VOSS polipotomo162	LOCH-WEBER asa67		
KROENING baja-lengua.....268	LOPEZ-REINKE disector.....290		
KUTZ-KLEINERT gancho.....247	LOTHROP separador288		
KUTZ-KLEINERT pinza gubia107	LOVE separador288		
	LUBET-BARBON pinza154		
L	LUC pinza157		
LABORDE dilatador.....314	LUCAE aguja.....70		
LAFORCE adenotomo.....309	LUCAE diapason59		
LAHEY gancho246	LUCAE gancho.....66, 250		
LAHEY pinza318	LUCAE pinza94, 152		
LAMBOTTE-MINI osteotomo..99, 229	LUCAS-BRÜNINGS gubia.....98		
lampara frontal.....24-27	LUER canula316		
lampara frontal CLAR26	LUER pinza gubia.....106		
LANGE gancho.....255	LUNIATSCHEK tamponador292		
LANGE punta354			
LANGENBECK asa65			

MINI-LAMBOTTE osteotomo..99, 229
 MINNESOTA-CAWOOD
 separador268
 Mod. WIEN especulo nasal143
 MOLLISON separador.....112
 MOLT (DOYEN-JANSEN)
 abre-boca271
 MOLT periostotomo92
 monopolar coagulador de succion..43
 MORITZ-SCHMIDT baja-lengua ..269
 MOSHER-WAGENER canula315

N

NAGER aguja.....286
 NAGER separador.....289
 nasolaringoscopio.....14
 NEGUS horquilla304
 NEGUS pinza281
 NEGUS soporte de pecho280
 NEIVERT-ANDERSON
 osteotomo.....233
 NEIVERT-COTTLE gancho252
 NEIVERT-MASING retractor251
 NEWS gancho315
 NOYES pinza155

O

O'BRIEN tijera199
 OBWEGESER osteotomo234
 oftalmoscopio UNI II49
 optica pinza15
 osteotomo
99-101, 228-229, 233-234
 osteotomo
 ANDERSON-NEIVERT233
 osteotomo LAMBOTTE-MINI..99, 229
 osteotomo LEXER228
 osteotomo LEXER MINI100
 osteotomo LEXER LEXER100
 osteotomo MINI-LAMBOTTE..99, 229
 osteotomo
 NEIVERT-ANDERSON.....233
 osteotomo OBWEGESER234
 osteotomo RUBIN.....234
 osteotomo SHEEHAN101, 232
 otoscopio17, 48
 otoscopio UNI I.....48

P

PAR-GREENBERG tijera202
 PARKES escofina.....238
 PARTSCH cincel99

PARTSCH gubia.....99
 PARTSCH martillo102, 260
 PASSOW cincel.....98, 235
 PECK-JOSEPH tijera201
 PEET escofina.....238
 PENNINGTON elevador.....224
 pera de goma61
 periostotomo.....86-93, 138, 227, 353
 periostotomo FARABEUF.....90
 periostotomo GUILLEN227
 periostotomo JANSEN.....91
 periostotomo JOSEPH88
 periostotomo KÖNIG86
 periostotomo LANGENBECK86
 periostotomo MILLER.....92
 periostotomo MOLT92
 periostotomo ROSEN.....93
 periostotomo WILLIGER.....87
 periostotomo WULLSTEIN92
 PERWITZSCHKY298
 PIERCE elevador223
 pinza ABRAHAM282
 pinza ADSON97
 pinza ASCH.....160
 pinza auricular ..74-79, 84-85, 94-97
 pinza BALLENGER281
 pinza BARBON-LUBET154
 pinza bipolar36-38, 40-42
 pinza BLAKESLEY180
 pinza BLAKESLEY-WEIL.....164, 168
 pinza BLOHMKE281
 pinza BROWNE DENIS.....283
 pinza BRUENINGS.....158
 pinza circular186
 pinza COLLIN.....270
 pinza COLVER281
 pinza COTTLE.....94, 152-153
 pinza CRAIG158
 pinza CRAIG-DOMNICK158
 pinza de diseccion.....95
 pinza de succion bipolar.....42
 pinza DENIS BROWNE.....283
 pinza DERLACKI.....97
 pinza DIETER.....84
 pinza DOMNICK-CRAIG158
 pinza DUPLAY295
 pinza
 FERRIS-SMITH-KERRISION.....181
 pinza FRAENKEL.....342
 pinza GELFOAM-HOUSE85
 pinza GILLIES151
 pinza GRAEFE95, 151

pinza GRUENWALD-JANSEN150
 pinza gubia106-108
 pinza gubia BANE-HARTMANN...106
 pinza gubia BEYER107
 pinza gubia BLUMENTHAL106
 pinza gubia BÖHLER107-108
 pinza gubia
 COTTLE-KAZANJIAN108, 208
 pinza gubia HARTMANN-BANE...106
 pinza gubia JANSEN-ZAUFAL107
 pinza gubia
 KAZANJIAN-COTTLE108, 208
 pinza gubia KLEINERT-KUTZ107
 pinza gubia KUTZ-KLEINERT107
 pinza gubia LEMPERT107
 pinza gubia LUER.....106
 pinza gubia MC INDOE108, 208
 pinza gubia ZAUFAL-JANSEN107
 pinza HAJEK-KOFLER.....182-183
 pinza HARTMANN
74-75, 154, 169, 175, 307
 pinza
 HARTMANN-HOFFMANN.....75, 175
 pinza
 HARTMANN-WEINGÄRTNER75
 pinza
 HARTMANN-WULLSTEIN75, 175
 pinza HEYMANN157
 pinza HEYMANN-KNIGHT156
 pinza
 HOFFMANN-HARTMANN.....75, 175
 pinza HOUSE-GELFOAM85
 pinza JANSEN150
 pinza JANSEN-GRUENWALD150
 pinza JANSEN-MIDDLETON159
 pinza JURASZ.....311, 342
 pinza
 KERRISON-FERRIS-SMITH.....181
 pinza KNIGHT157
 pinza KNIGHT-HEYMANN156
 pinza KOFLER-HAJEK.....182-183
 pinza LAHEY318
 pinza laringeal JACKSON343
 pinza LISTER (SINUS).....155
 pinza LITTAUER.....74, 156
 pinza LUBET-BARBON154
 pinza LUC157
 pinza LUCAE94, 152
 pinza MARSCHIK282
 pinza MASTIN318
 pinza McINDOE.....151
 pinza micro131, 350-351

pinza MIDDLETON-JANSEN 159
 pinza MIKULICZ 283
 pinza nasal 149-161, 164-186
 pinza naso-faringea JATHO 310
 pinza naso-faringea
 ST.CLAIR-THOMSON 310
 pinza NEGUS 281
 pinza NOYES 155
 pinza optica 15
 pinza para amigdalas 281-283
 pinza para antro 184-185
 pinza para biopsia 167, 179
 pinza para bronco-esofagoscopia
 CHEVALIER-JACKSON 356
 pinza para bronco-esofagoscopia
 JACKSON-CHEVALIER 356
 pinza porta-esponja 295
 pinza relojero 96
 pinza RUBIN 161
 pinza sacabocado 109
 pinza sacabocado CITELLI 109
 pinza sacabocado
 KERRISON 109, 182
 pinza SAWTELL 281
 pinza SCHMEDEN 169
 pinza SCHNIDT 281
 pinza SEMKEN 95
 pinza SINUS (LISTER) 155
 pinza
 SMITH-FERRIS-KERRISON 181
 pinza STANDARD 95
 pinza STRUEMPEL 75
 pinza STRUYCKEN 169
 pinza TAKAHASHI 165
 pinza THILENIUS 283
 pinza TILLEY 74, 155
 pinza TROELTSCH 149
 pinza TROELTSCH (WILDE) .. 94, 152
 pinza TYDING 282
 pinza WALSHAM 160
 pinza WATSON-WILLIAMS 166
 pinza WEIL-BLAKESLEY 164, 168
 pinza
 WEINGÄRTNER-HARTMANN 75
 pinza WESTMACOTT 154
 pinza WHITE 281
 pinza WILDE (TROELTSCH) .. 94, 152
 pinza WILLIAMS-WATSON 166
 pinza WULLSTEIN 79
 pinza
 WULLSTEIN-HARTMANN 75, 175
 pinza YOUNG 270

placa para el paladar 277
 placa para extender la piel 220
 PLESTER cuchillo 122
 PLESTER gancho 137
 PLESTER separador 113, 264
 PLESTER tubo de aspiracion 126
 polipotomo 72, 162-163
 polipotomo KRAUSE 72, 162
 polipotomo KRAUSE-VOSS 162
 polipotomo VOSS-KRAUSE 162
 polipotomo WILDE 72, 163
 POLITZER aguja 70-71
 POLITZER cuchillo 71
 POLITZER espejuelo auricular 53
 POLITZER insuflador de aire 61
 porta aguja 123-124, 209, 349
 porta aguja BABY-WEBSTER 209
 porta aguja BARRAQUER 123
 porta aguja CASTROVIEJO 124
 porta aguja CRILE-WOOD 209
 porta aguja DERF 209
 porta aguja HALSEY 209
 porta aguja WEBSTER 209
 porta aguja WEBSTER-BABY 209
 porta aguja WOOD-CRILE 209
 porta-algodon 63-64
 porta-algodon 347
 porta-algodon FARRELL 63
 porta-algodon FEIN 347
 porta-algodon FROHN 63
 porta-algodon JOBSON-HORNE .. 64
 porta-algodon KILLIAN 347
 porta-algodon REDA 64
 porta-algodon UCKERMANN 64
 portador de luz 334, 337-341
 PRINCE tijera 296
 punta BARACANI 354
 punta BRUENINGS 354
 punta CORDES 354
 punta FRAENKEL 354
 punta KRAUSE 354
 punta LANGE 354
 punta SCHEINMANN 354
 punta SCHUMACHER 354
 punta SEIFERT 354

Q

QUERVAIN elevador 86
 QUIRE elevador 73
 QUISLING martillo 260

R

RAGNELL (KILNER) tijera 191
 REDA bisturi 217
 REDA espejuelo nasal 144
 REDA gancho 249
 REDA porta-algodon 64
 REICHERT depresor 343
 REINER jeringa 61
 REINKE-LOPEZ disector 290
 retractor AUFRIEHT 251
 retractor COTTLE 251
 retractor MASING-NEIVERT 251
 retractor nasal 251
 retractor NEIVERT-MASING 251
 REYNOLDS (JAMESON) tijera 191
 RI-MINI estuche diagnostico 52
 RITTER-HALLE sonda 261
 ROEDER "E" cierranudo 303
 ROGER elevador 222
 ROLLET gancho 250
 ROSEN / BARBARA aguja ... 135, 136
 ROSEN cuchillo 120
 ROSEN periostotomo 93
 ROSEN tubo de aspiracion 129
 ROSER-KOENIG abre-boca 271
 ROUX BABY separador 263
 RUBIN osteotomo 234
 RUBIN pinza 161
 RUSSEL-DAVIS baja-lengua 278
 RYDEL-SEIFFERT diapason 59

S

SANVENERO tijera 190
 SAWTELL pinza 281
 SCHEINMANN punta 354
 SCHINK dermatomo 220
 SCHMEDEN pinza 169
 SCHMIDT-MORITZ baja-lengua .. 269
 SCHNIDT pinza 281
 SCHOENBORN separador 317
 SCHUKNECHT cuchillo 122
 SCHUKNECHT
 dispositivo para modelar 85
 SCHUKNECHT tijera 81
 SCHUMACHER punta 354
 SEBILEAU elevador 86
 SEIFERT punta 354
 SEMKEN pinza 95
 separador 110-114, 148, 263-265,
 268, 270, 288-289, 314, 317
 separador ADSON 112
 separador ALM 110

separador BABY ROUX	263	SLUDER-BALLENGER		tijera COTTLE	194, 198
separador BOSE	314	amigdalotomo	305	tijera COTTLE-MASING	198
separador BRÜNINGS-BRUNK	263	SMITH-FERRIS-KERRISON		tijera DEAN	296
separador BRUNK-BRÜNINGS	263	pinza	181	tijera FISCH	82
separador		sonda63, 132, 261-262, 293, 317		tijera FOMON	198
CAWOOD-MINNESOTA	268	sonda auricular STACKE	63	tijera FREEMAN-GORNEY	200
separador FINSEN	110	sonda BOWMAN	262, 293	tijera GOOD	296
separador FISCH	112, 265	sonda FRONTAL	261	tijera GORNEY	116, 200
separador HOFER	289	sonda HALLE-RITTER	261	tijera GORNEY-FREEMAN	200
separador HOLZHEIMER	110	sonda HOUSE	132	tijera GRADLE	195
separador JANSEN	110	sonda KOCHER	317	tijera GRAEFE	194
separador		sonda RITTER-HALLE	261	tijera GREENBERG-PAR	202
KOCHER-LANGENBECK	263	sonda SINUS	261	tijera GREVEN	81
separador		soporte	57, 280, 335-336	tijera HEYMAN	198
LANGENBECK-KOCHER	263	soporte de pecho NEGUS	280	tijera IRIS	117, 192
separador LEYLA	148	soporte para espejuelos		tijera JAMESON (REYNOLDS)	191
separador LOTHROP	288	auriculares	57	tijera JOSEPH	116, 190
separador LOVE	288	soporte para espejuelos		tijera JOSEPH-PECK	201
separador MIDDELDORPF	263	auriculares YASARGIL	57	tijera KAYE	201-202
separador		soporte pectoral LEWY	336	tijera KELLY	191
MINNESOTA-CAWOOD	268	SPENCER tijera	199	tijera KILLIAN	343
separador MOLLISON	112	SPRATT cucharilla	103	tijera KILNER (RAGNELL)	191
separador NAGER	289	St. CLAIR-THOMSON cuchillo	309	tijera KNAPP	193
separador PLESTER	113, 264	ST.CLAIR-THOMSON		tijera LITTAUER	199
separador ROUX BABY	263	pinza naso-faringea	310	tijera LITTLER	194
separador SCHOENBORN	317	STACKE sonda auricular	63	tijera MASING-COTTLE	198
separador STERNBERG	270	STANDARD pinza	95	tijera MCGEE	81
separador WEITLANER	111	STANDARD tijera	117	tijera METZENBAUM	
separador		STERNBERG separador	270115, 188-189, 297	
WEITLANER-WULLSTEIN	111	STEVENS tijera	196	tijera METZENBAUM FINO	115, 189
separador WILLIGER	114	STRABISMUS tijera	116, 196	tijera micro	119, 131, 203-205, 351
separador WULLSTEIN	113	STRUEMPPEL pinza	75	tijera nasal	187-207
separador		STRUYCKEN pinza	169	tijera O'BRIEN	199
WULLSTEIN-WEITLANER	111			tijera para alambre y	
SET	358-372	T		laminas	118, 299
SEWALL elevador	226	TABB cuchillo	122	tijera para amígdalas	296-298
SEXTON cuchillo	71	TAKAHASHI pinza	165	tijera para el canal de saliva	298
SHAMBAUGH gancho	135	tamponador LUNIATSCHEK	292	tijera para tumores	207
SHAPLEIGH asa	67	THILENIUS pinza	283	tijera PAR-GREENBERG	202
SHEA cucharilla	134	THOMSON-St. CLAIR cuchillo	309	tijera PECK-JOSEPH	201
SHEA tijera	80	THUDICHUM espejuelo nasal	140	tijera PERWITZSCHKY	298
SHEEHAN osteotomo	101, 232	TIECK-HALLE espejuelo nasal	144	tijera PRINCE	296
SIEGLE espejuelo auricular	56	tijera	80-83, 115-119, 187-207,	tijera RAGNELL (KILNER)	191
sierra nasal	244-245	296-299, 343	tijera REYNOLDS (JAMESON)	191
sierra nasal JOSEPH	244-245	tijera auricular	80-83	tijera SANVENERO	190
sierra nasal LINDEMANN	245	tijera BELLUCCI	80	tijera SCHUKNECHT	81
SILVER cincel	233	tijera BEUSE	201	tijera SHEA	80
SILVER dermatomo	221	tijera BOETTCHER	296	tijera SPENCER	199
SINUS (LISTER) pinza	155	tijera BONN	192	tijera STANDARD	117
SINUS elevador	223	tijera CAPLAN	206	tijera STEVENS	196
SINUS sonda	261	tijera CONVERSE/WILMER/		tijera STRABISMUS	116, 196
sinuscopio	15	WALTER	194	tijera UNIVERSAL	118, 299

tijera WAGNER	197	U	WULLSTEIN periostotomo	92
tijera WALTER/CONVERSE/		UCKERMANN porta-algodon	WULLSTEIN pinza	79
WILMER	194	UNI I otoscopio	WULLSTEIN separador	113
tijera WILMER/CONVERSE/		UNI II oftalmoscopio	WULLSTEIN tijera	83
WALTER	194	UNI III estuche diagnostico	WULLSTEIN-HARTMANN pinza	
tijera WULLSTEIN	83	UNIVERSAL lanzapolvo	75, 175
TILLEY pinza	74, 155	UNIVERSAL tijera	WULLSTEIN-WEITLANER	
TOBOLD baja-lengua	270		separador	111
TOYNBEE especulo auricular	53	V		
transformador	26	VOLKMANN cucharilla		
trocar COAKLEY	215	VOLTOLINI especulo nasal		
trocar LICHTWITZ	215	VOSS-KRAUSE polipotomo		
trocar para sinoscopia	215			
TROELTSCH (WILDE) pinza..	94, 152	W		
TROELTSCH pinza	149	WAGENER gancho		
TROUSSEAU dilatador	314	WAGENER-MOSHER canula		
TROUSSEAU-BABY dilatador	314	WAGNER tijera		
tubo de aspiracion 125-129, 284, 348		WALSHAM pinza		
tubo de aspiracion BARON	128	WALTER cincel		
tubo de aspiracion EICKEN		WALTER/CONVERSE/		
(KILLIAN)	212	WALTER tijera		
tubo de aspiracion		WATSON dermatomo		
FERGUSSON	213	WATSON-WILLIAMS pinza		
tubo de aspiracion		WEBER-LOCH asa		
FERGUSSON / FRAZIER	125, 213	WEBSTER porta aguja		
tubo de aspiracion		WEBSTER-BABY porta aguja		
FRAZIER / FERGUSON	125, 213	WEIL-BLAKESLEY pinza		164, 168
tubo de aspiracion HOUSE ..	126, 214	WEINGÄRTNER-HARTMANN		
tubo de aspiracion KILLIAN	212	pinza		75
tubo de aspiracion KILLIAN		WEISS-DUPUY aguja		285
(EICKEN)	212	WEITLANER separador		111
tubo de aspiracion PLESTER	126	WEITLANER-WULLSTEIN		
tubo de aspiracion ROSEN	129	separador		111
tubo de aspiracion ZÖLLNER	125	WEST cincel		236
tubo de extension BRUENINGS	354	WESTMACOTT pinza		154
tubo de silicona	277	WHITE pinza		281
tubo de succion		WIEDER baja-lengua		269
BABY-YANKAUER	284	WIEN Mod. especulo nasal		143
tubo de succion y coagulacion		WIENER escofina		238
.....	211, 348	WILDE (TROELTSCH) pinza		94, 152
tubo de succion YANKAUER	284	WILDE polipotomo		72, 163
tubo de succion		WILDER dilatador		261
YANKAUER-BABY	284	WILLIAMS-WATSON pinza		166
TYDING cierranudo	300	WILLIGER cucharilla		105
TYDING pinza	282	WILLIGER periostotomo		87
		WILLIGER separador		114
		WILMER/CONVERSE/		
		WALTER tijera		194
		WOOD-CRILE porta aguja		209
		WULLSTEIN cuchillo		122
		WULLSTEIN		
		mango de succion		127, 129

Weitere Kataloge und Prospekte
Other cataloges and prospects

Hauptkatalog Chirurgische Instrumente
General catalog surgical instruments

Arthroskopie
Arthroscopy

Container Steriltechnik
Container Sterilization Technique

Endoskopie
Endoscopy

HERCULES® Drahtkneifzange
HERCULES® Wire Cutters

Plastische Chirurgie
Plastic surgery

Orthopädie
Orthopedic

Titan Instrumente
Titanium Instruments

Neurochirurgie
Neurosurgery



INSTRUMENTE GMBH

Gänsäcker 34
P.O. Box 131
D-78532 Tuttlingen
Germany



Fon +49 74 62.94 45-0
Fax +49 74 62.94 45-20
info@Reda-Instrumente.de
www.Reda-Instrumente.de